

PRODUCT DATASHEET

LN INV DI 1500 P 69W 930 DAVR WT

LINEAR INDIVILED DIRECT/INDIRECT 1500 DALI | Pendant luminaire for single or light line office application with CRI90 and DALI-2 IoT technology, 1500 mm



Areas of application

- Direct replacement for luminaires with fluorescent lamps
- Offices, education, public buildings
- Single and continuous line configuration
- Direct and indirect lighting

Product benefits

- Easy upgradeability of light source and driver (EVERLOOP design)
- Homogenous light distribution and reduced glare ($UGR \leq 19$) thanks to IndiviLED® optics
- Pendant luminaires with direct light emission (70%) and indirect light emission (30%)
- High performance with CRI90 and up to 131 lm/W
- IoT-ready luminaire with DALI-2 driver, suitable for VIVARES and other Light Management Systems
- Extended services such as energy monitoring and remote maintenance possible with DALI versions
- High color consistency with SDCM 3
- Easy installation
- Low flicker light thanks to special electronic control gear
- Suitable for battery emergency installations acc. to EN 60598-2-22
- Multiple mounting options thanks to different accessories

Product features

- Minimalistic LEDVANCE SCALE design in extruded aluminum housing, available in white and black color



- Includes EVERLOOP: Convenient replacement of light source and LED driver
- Linkable into seamless light line with accessories (surface or pendant mounting)
- Pendant mounting with suspension kit (to be ordered separately)
- Glow Wire Test according to IEC 60695-2-12: 850 °C
- 5-pole terminal block, cable cross section up to 5 x 2.5 mm²
- Lifetime (L80/B10): 70,000 h (at 25 °C)

TECHNICAL DATA

Electrical data

Nominal wattage	69 W / 63 W / 60 W / 54 W
Nominal voltage	220...240 V
Mains frequency	0/50/60 Hz
Nominal current	308...285...270...240 mA
Inrush current	23.6 A
Inrush current time T_{h50}	200 μ s
Max. number of luminaires per miniature circuit breaker B16	23
Max. number of luminaires per miniature circuit breaker C10	20
Max. number of luminaires per miniature circuit breaker C16	32
Power factor λ	≥ 0.90
Total harmonic distortion	≤ 20 %
Protection class	I
Operating mode	Integrated LED driver
Dimming interface	DALI-2 / IoT

Photometrical data

Luminous flux	8150 lm / 7650 lm / 7300 lm / 6650 lm
Luminous efficacy	118 lm/W / 121 lm/W / 122 lm/W / 123 lm/W
Color temperature	3000 K
Light color (designation)	Warm White
Color rendering index Ra	> 90
Standard deviation of color matching	3 sdc _m
Low flicker	Yes
Flickering metric (Pst LM)	≤ 1
Stroboscope effect metric (SVM)	≤ 0.4
Photobiological safety group acc. to EN62778	RG0
Photobiological safety group acc. to EN62471	RG0
Beam angle	90 ° + 130 °
UGR	< 19

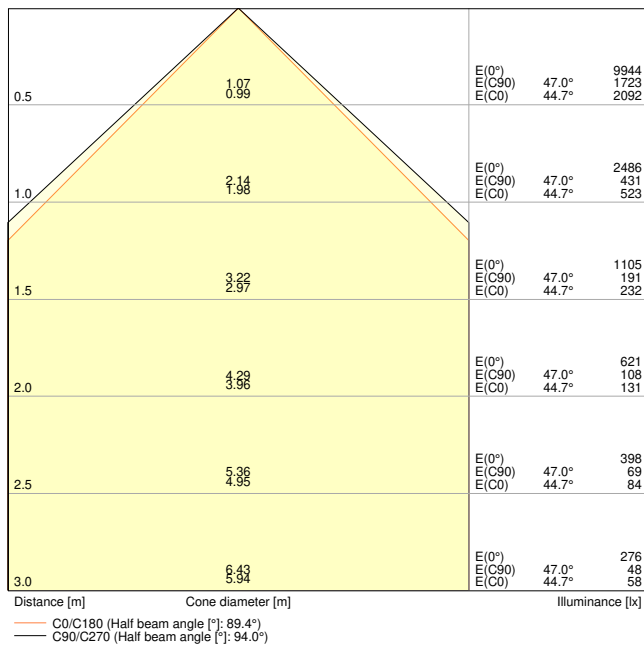

LN INV DI 1500 P 69W 930 DAVR WT 1400mA

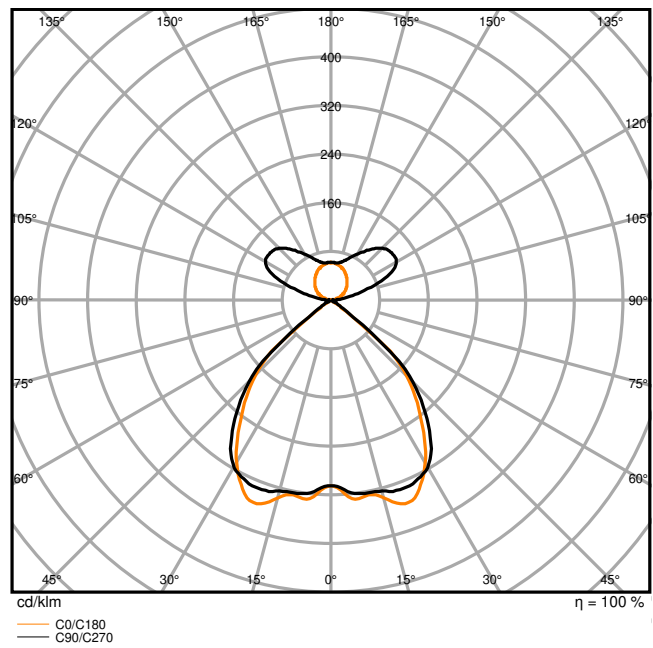

LN INV DI 1500 P 69W 930 DAVR WT 1400mA

Dimensions & Weight

Length	1475.00 mm
Width	125.00 mm
Height	43.00 mm
Product weight	4160.00 g

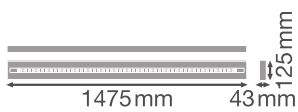

LN INV 1500 P

Materials & Colors

Product color	White
Housing color	White
Body material	Aluminum
Cover material	Polymethylmethacrylate (PMMA)
Light emitting surface material	Polymethylmethacrylate (PMMA)
Glow Wire Test according to IEC 60695-2-12	850 °C
Mercury content	0.0 mg

Application & Mounting

Ambient temperature range	-20...+50 °C
Temperature range at storage	-20...+80 °C
Type of connection	Screwless terminal, 5-Pole (L, N, PE, DA+, DA-)
Type of protection	IP20
Protection class IK (shock resistance)	IK06
Dimmable	Yes
Type of dimming	DALI2
Mounting type	Suspended
Mounting location	Ceiling
Application environment	Indoor
Adjustable	No
With light source	Yes

Lifespan

Lifespan L70/B50 at 25 °C	100000 h ¹⁾
Lifespan L80/B10 at 25 °C	70000 h ¹⁾
Lifespan L80/B50 at 25 °C	70000 h
Lifespan L90/B10 at 25 °C	35000 h
Number of switching cycles	25000

¹⁾ t[h]: L70 / B50 @ 25 °C (Ta), t[h]: L80 / B10 @ 25 °C (Ta), t[h]: L90 / B10 @ 25 °C (Ta)

Control gear

Output current	1400 mA
ECG - Output ripple current	≤ 3 %
Recommended control gear	OSRAM type ETI DALI 75/220-240/1A4 LT2

Certificates & Standards

Standards	CE / CB / ENEC / TÜV SÜD / UKCA / EAC / EPD
Luminaire with limited surface temperature, "D sign"	No
Ball shot safe	No
EPD	LEDV-00026-V01.01-EN
Replaceable light source (EPREL)	By the end consumer





Additional product data



Number of illuminants	2
Added function	EVERLOOP / VIVARES / Programmable Multi Lumen

Accessories Mandatory

Product image	Product name	EAN
	LN INV SUSPENSION KIT WT	4099854215537

Accessories Optional









Product image	Product name	EAN
	LN INV CORNER CONNECTOR WT	4099854214905
	LN INV SUSPENSION WIRE	4099854215551
	LN INV 1500 THROUGHWIRING KIT	4099854214806
	LN INV INFILL 1500 WT	4099854214844
	LN INV INFILL 600 WT	4099854214882









Product image	Product name	EAN
	LN INV INFILL 1200 WT	4099854214868
	LN INV INLINE CONNECTOR	4099854215612

EQUIPMENT / ACCESSORIES

- Suspension kit available for pendant luminaire version (to be ordered separately)
- Inline, corner and infill connectors available as separate accessory
- Through-wiring cable kit available

DOWNLOAD DATA

Documents and certificates		Document name
	User instruction / safety instructions	LN INV D PS
	Legal information	LN INV DALI
	Legal information	LSI LN INV DAVR WT
	Legal information	Legal Insert LN INV P DA
	Legal information	Informationstext 18 Abs 4 ElektroG
	Declarations of conformity	LN INV
	Declarations of conformity UKCA	LN INV
Photometric and lighting design files		Document name
	IES file (IES)	LN INV DI 1500 P 69W 930 DAVR WT 1400mA
	LDT file (Eulumdat)	LN INV DI 1500 P 69W 930 DAVR WT 1400mA

Photometric and lighting design files		Document name
	ULD file (DIALux)	LN INV DI 1500 P 69W 930 DAVR WT
	ROLF file (RELUX)	LN INV DI 1500 P 69W 930 DAVR WT
	UGR file (UGR table)	LN INV DI 1500 P 69W 930 DAVR WT 1400mA
	Light distribution curve type cone	LN INV DI 1500 P 69W 930 DAVR WT 1400mA
	Light distribution curve type polar	LN INV DI 1500 P 69W 930 DAVR WT 1400mA
CAD/BIM files		Document name
	BIM Revit 3D	Linear Indiviled G2
	CAD STEP 3D	LN INV D I 1500 G2.
Tender texts		Document name
	Tender documents	LINEAR INDIVILED DIRECTINDIRECT 1500 DALI 1500 P 69W 930 DAVR WT-EN

LOGISTICAL DATA

Product code	Packaging unit (Pieces/Unit)	Dimensions (length x width x height)	Gross weight	Volume
4099854135637	Folding box 1	1,252 mm x 167 mm x 87 mm	4860.00 g	18.19 dm ³
4099854135644	Shipping box 2	1,547 mm x 187 mm x 189 mm	11320.00 g	54.68 dm ³

The mentioned product code describes the smallest quantity unit which can be ordered. One shipping unit can contain one or more single products. When placing an order, for the quantity please enter single or multiples of a shipping unit.

ADDITIONAL CATALOG INFORMATION

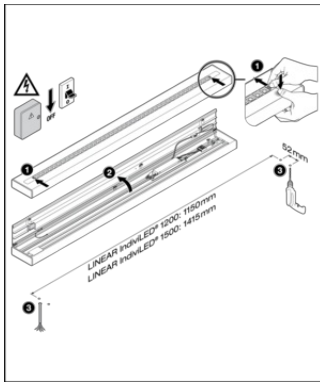

LINEAR INHULED® DRIVING DALI WT	DRIVER	DIRECT		INDIRECT		Total	PC	DALI
		W	H	W	H			
LN INV DI 1500 P 64W DAVR WT	OSRAM	100	100	100	100	100	100	100
	ET-DALI 750	100	100	100	100	100	100	100
	1AA L72	100	100	100	100	100	100	100
LN INV DI 1500 P 89W 930 DAVR WT	OSRAM	100	100	100	100	100	100	100
	ET-DALI 750	100	100	100	100	100	100	100
	1AA L72	100	100	100	100	100	100	100

LINEAR INHULED® DRIVING DALI WT	DRIVER	DIRECT		INDIRECT		Total	PC	DALI
		W	H	W	H			
LN INV DI 1500 P 64W DAVR WT	OSRAM	100	100	100	100	100	100	100
	ET-DALI 750	100	100	100	100	100	100	100
	1AA L72	100	100	100	100	100	100	100
LN INV DI 1500 P 89W 930 DAVR WT	OSRAM	100	100	100	100	100	100	100
	ET-DALI 750	100	100	100	100	100	100	100
	1AA L72	100	100	100	100	100	100	100

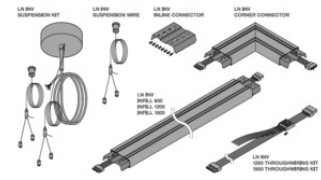
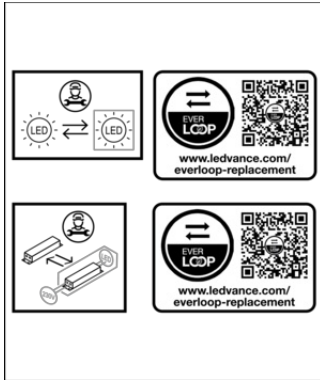

References / Links

- For Guarantee see www.ledvance.com/guarantee

DISCLAIMER

Subject to change without notice. Errors and omission excepted. Always make sure to use the most recent release.