

Solid-state Timers

H3DK

DIN Track-mounted, 22.5-mm-width Standard Timer Series



- A wide AC/DC power supply range (24 to 240 VAC/DC).^{*1}
- All sub-series include models with 12-VDC power supply.^{*1}
- G-type Models (H3DK-G) now include model with 240 to 440-VAC power supply.
- UL^{*2}, CSA^{*3}, and CCC certification and EN 61812-1 compliance. CE Marking.
- EMC (EN 61812-1) compliance for application in heavy industrial, residential, commercial, or light industrial environments.
- Finger-safe terminal block and captive screws according to EN 50274.



For the most recent information on models that have been certified for safety standards, refer to your OMRON website.

^{*1}. Except for the H3DK-H.
^{*2}. Except for the H3DK-GE.
^{*3}. Scheduled to obtain certification in April 2012.

Model Number Structure

■ The Entire H3DK Series

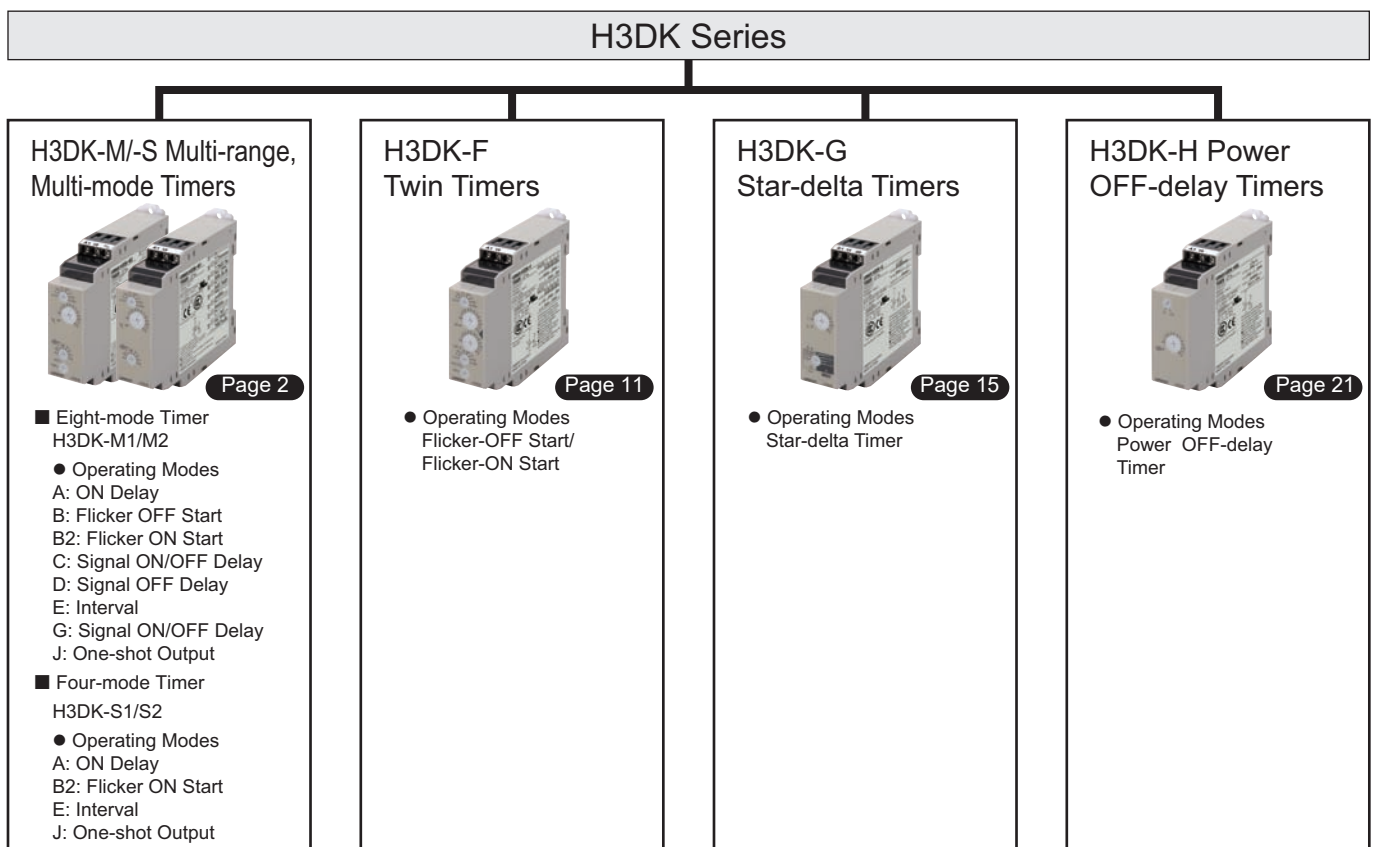

■ Model Number Legend (Not all models that can be represented with the model number legend can necessarily be produced.)

H3DK-□□□□
 1 2 3 4

1. Type

Symbol	Meaning
M	Eight-mode Timer
S	Four-mode Timer
F	Twin Timer
G	Star-delta Timer
H	Power OFF-delay Timer

2. Control Output

Symbol	Meaning
1	SPDT
2	DPDT

^{*} M- and S-type models only.

3. Supply Voltage

Symbol	Meaning
Blank	24 to 240 VAC/DC
A	12 VDC
B	24 to 48 VAC/DC
C *1	100 to 120 VAC
D *1	200 to 240 VAC
E *1	240 to 440 VAC *2

^{*1} H-type models only.

^{*2} G-type models only.

4. Time Ranges (H-type Models Only)

Symbol	Meaning
S	0.1 to 1.2 s or 1 to 12 s
L	1 to 12 s or 10 to 120 s

Multi-range, Multi-mode Timer H3DK-M/H3DK-S

- Multiple time ranges and operating modes let you cover a wide range of applications.
- The time-limit DPDT output contacts can be changed to time-limit SPDT and instantaneous SPDT output contacts using a switch.
- Sequence checks are easily performed by setting an instantaneous output to 0.
- Start signal control for the H3DK-M.



For the most recent information on models that have been certified for safety standards, refer to your OMRON website.

Ordering Information

List of Models

Supply voltage		Control output		Eight-mode Timer	Four-mode Timer
24 to 240 VAC/DC	Contact output, DPDT (time-limit DPDT, or time-limit SPDT + instantaneous SPDT) Changed using a switch.	Model		H3DK-M2	H3DK-S2
	Contact output, SPDT (time-limit SPDT)	Model		H3DK-M1	H3DK-S1
12 VDC	Contact output, DPDT (time-limit DPDT, or time-limit SPDT + instantaneous SPDT) Changed using a switch.	Model		H3DK-M2A	H3DK-S2A
	Contact output, SPDT (time-limit SPDT)	Model		H3DK-M1A	H3DK-S1A

Accessories (Order Separately)

Item	Specification	Model
Mounting Track	50 cm (l) x 7.3 mm (t)	PFP-50N
	1 m (l) x 7.3 mm (t)	PFP-100N
	1 m (l) x 16 mm (t)	PFP-100N2
End Plate	---	PFP-M
Spacer	---	PFP-S

Model Structure

Model	Operating modes	Terminal block	Input type	Output type	Mounting method	Safety standards	Accessories
H3DK-M2	A: ON Delay B: Flicker OFF start B2: Flicker ON start C: Signal ON/OFF Delay D: Signal OFF Delay E: Interval G: Signal ON/OFF Delay J: One-shot Output	9 terminals	Voltage input	Relay, DPDT	DIN Track mounting	cURus (UL 508 CSA C22.2 No. 14) EN 61812-1 IEC 60664-1 4 kV/2 EN 50274	User label
H3DK-M1	Relay, SPDT						
H3DK-S2	A: ON Delay B2: Flicker ON start E: Interval	6 terminals	---	Relay, DPDT			
H3DK-S1	E: Interval J: One-shot Output			Relay, SPDT			

Specifications

■ Time Ranges

Time range setting	0.1 s	1 s	10 s	1 min	10 min	1 h	10 h	100 h
Set time range	0.1 to 1.2 s	1 to 12 s	10 to 120 s	1 to 12 min	10 to 120 min	1 to 12 h	10 to 120 h	100 to 1,200 h
Scale numbers	12							

Note: When the main dial is set to "0" for all settings, the output will operate instantaneously.

■ Ratings

Power supply voltage *1	• 24 to 240 VAC/DC, 50/60 Hz *2 • 12 VDC *2	
Allowable voltage fluctuation range	• 24 to 240 VAC/DC: 85% to 110% of rated voltage • 12 VDC: 90% to 110% of rated voltage	
Power reset	Minimum power-OFF time: 0.1 s	
Reset voltage	10% of rated voltage	
Voltage input	• 24 to 240 VAC/DC High level: 20.4 to 264 VAC/DC, Low level: 0 to 2.4 VAC/DC • 12 VDC High level: 10.8 to 13.2 VDC, Low level: 0 to 1.2 VDC	
Power consumption *3	H3DK-M2/-S2	At 240 VAC: 6.6 VA max. *4
	H3DK-M1/-S1	At 240 VAC: 4.5 VA max. *4
	H3DK-M2A/-S2A	At 12 VDC: 0.9 W max.
	H3DK-M1A/-S1A	At 12 VDC: 0.6 W max.
Control output	Contact output: 5 A at 250 VAC with resistive load ($\cos\phi = 1$), 5 A at 30 VDC with resistive load *5, 0.15 A max. at 125 VDC with resistive load, 0.1A at 125 VDC with L/R of 7 ms. The minimum applicable load is 10 mA at 5 VDC (P reference value). Contact materials : Ag-alloy + Gold plating	
Ambient operating temperature	-20 to 55°C (with no icing)	
Storage temperature	-40 to 70°C (with no icing)	
Ambient operating humidity	25% to 85%	

- *1. When using a 24-VDC power supply voltage, there will be an inrush current of approximately 0.25 A. Allow for this inrush current when turning ON and OFF the power supply to the Timer with device with a solid-state output, such as a sensor.
- *2. DC ripple: 20% max.
- *3. The power consumption is for mode A after the Timer times out.
For the H3DK-M□, the maximum power consumption is given, including the current consumed by the input circuit.
- *4. Refer to *DC Power Consumptions (Reference Information)* on page 27 for DC power consumptions.
- *5. The control output ratings are for one H3DK operating alone. If you operate two or more Timers side by side, refer to *Installation Pitch and Output Switching Capacity (Reference Values)* on the next page.

■ Characteristics

Accuracy of operating time	±1% of FS max. (±1% ±10 ms max. at 1.2-s range)*	
Setting error	±10% of FS ±0.05 s max.*	
Minimum input signal width	50 ms* (start input)	
Influence of voltage	±0.5% of FS max. (±0.5% ±10 ms max. at 1.2-s range)	
Influence of temperature	±2% of FS max. (±2% ±10 ms max. at 1.2-s range)	
Insulation resistance	100 MΩ min. at 500 VDC	
Dielectric strength	Between current-carrying metal parts and exposed non-current-carrying metal parts: 2,000 VAC 50/60 Hz for 1 min. Between control output terminals and operating circuit: 2,000 VAC 50/60 Hz for 1 min. Between contacts not located next to each other: 1,000 VAC 50/60 Hz for 1 min.	
Impulse withstand voltage	24 to 240 VAC/VDC: 5 kV between power terminals, 5 kV between current-carrying metal parts and exposed non-current-carrying metal parts 12 VDC: 1 kV between power terminals, 1.5 kV between current-carrying metal parts and exposed non-current-carrying metal parts	
Noise immunity	Square-wave noise generated by noise simulator (pulse width: 100 ns/1 μs, 1-ns rise): ±1.5 kV	
Static immunity	Malfunction: 4 kV, Destruction: 8 kV	
Vibration resistance	Destruction	0.75-mm single amplitude at 10 to 55 Hz for 2 h each in 3 directions
	Malfunction	0.5-mm single amplitude at 10 to 55 Hz for 10 min each in 3 directions
Shock resistance	Destruction	1,000 m/s ² 3 times each in 6 directions
	Malfunction	100 m/s ² 3 times each in 6 directions
Life expectancy	Mechanical	10 million operations min. (under no load at 1,800 operations/h)
	Electrical	100,000 operations min. (5 A at 250 VAC, resistive load at 360 operations/h)
Degree of protection	IP30 (Terminal block: IP20)	
Weight	Approx. 120 g	

* With the H3DK-M□, if the voltage exceeds 26.4 VAC/DC in mode C, D, or G, the OFF trigger signal characteristics are as follows:

Accuracy of operating time: ±1% ±50 ms max.
Setting error: ±10% $\begin{matrix} +100 \text{ ms} \\ -50 \text{ ms} \end{matrix}$ max.
Minimum input signal width: 100 ms

■ Applicable standards

Safety standards	cURus: UL 508/CSA C22.2 No. 14 EN 50274: Finger protection, back-of-hand proof EN 61812-1: Pollution degree 2, Overvoltage category III CCC: GB/T 14048.5 Pollution degree 2, Overvoltage category III * LR: Test Specification No. 1-2002 Category ENV 1.2
EMC	(EMI) Radiated Emissions: EN61812-1 EN 55011 class B Emission AC Mains: EN 55011 class B Harmonic Current: EN 61000-3-2 Voltage Fluctuations and Flicker: EN61000-3-3 (EMS) Immunity ESD: EN61812-1 IEC61000-4-2 Immunity RF-interference: IEC61000-4-3 Immunity Burst: IEC61000-4-4 Immunity Surge: IEC61000-4-5 Immunity Conducted Disturbance: IEC61000-4-6 Immunity Voltage Dip/Interruption: IEC61000-4-11

* CCC certification requirements

Recommended fuse	0216005 (250 VAC, 5 A) manufactured by Littelfuse
Rated operating voltage Ue Rated operating current Ie	AC-15: Ue: 250 VAC, Ie: 3 A AC-13: Ue: 250 VAC, Ie: 5 A DC-13: Ue: 30 VDC, Ie: 0.1 A
Rated insulation voltage	250 V
Rated impulse withstand voltage (altitude: 2,000 m max.)	4 kV (at 240 VAC)
Conditional short-circuit current	1,000 A

● Installation Pitch and Output Switching Capacity (Reference Values)

The relation between the installation pitch and the load current is shown in the following graph. (Except for the H3DK-GE)
If Timer is used under load conditions that exceed the specified values, the temperature inside the Timer will increase, reducing the life expectancy of internal parts.

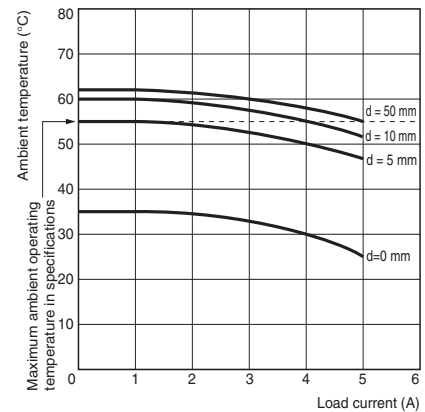

Testing Method

Tested Timer: H3DK-M/S
Applied voltage: 240 VAC
Installation pitch: 0, 5, 10, and 50 mm

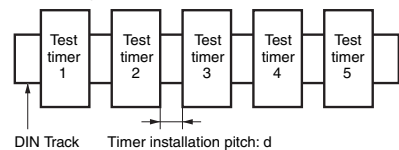

Connections

■ Block Diagrams

H3DK-M1/-M2

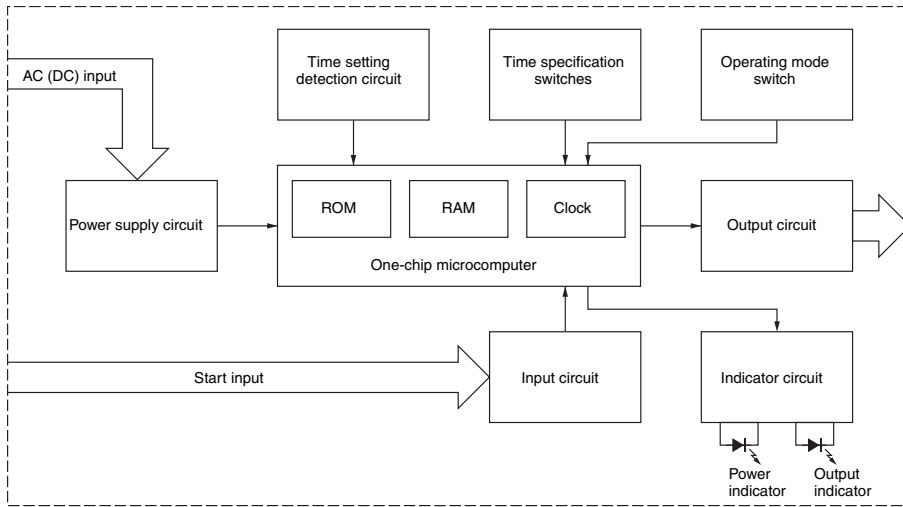

H3DK-S1/-S2

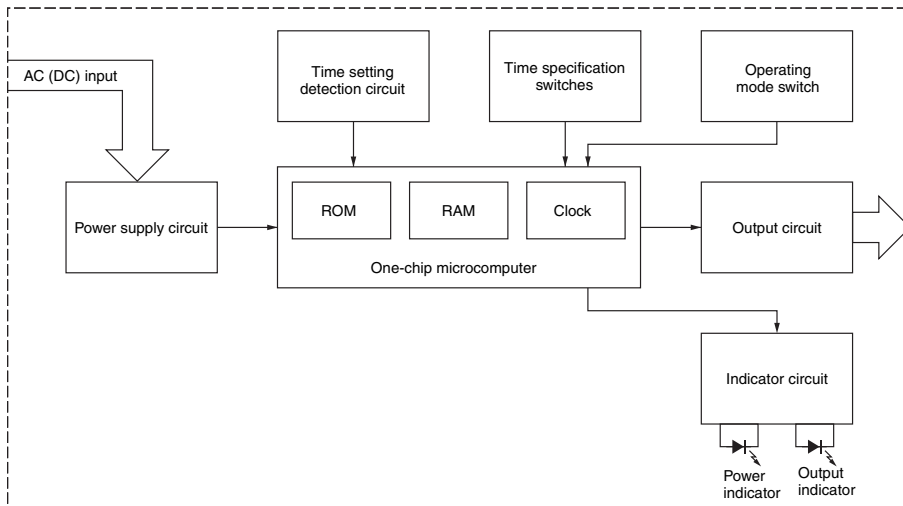

H3DK-M/H3DK-S

Terminal Arrangement

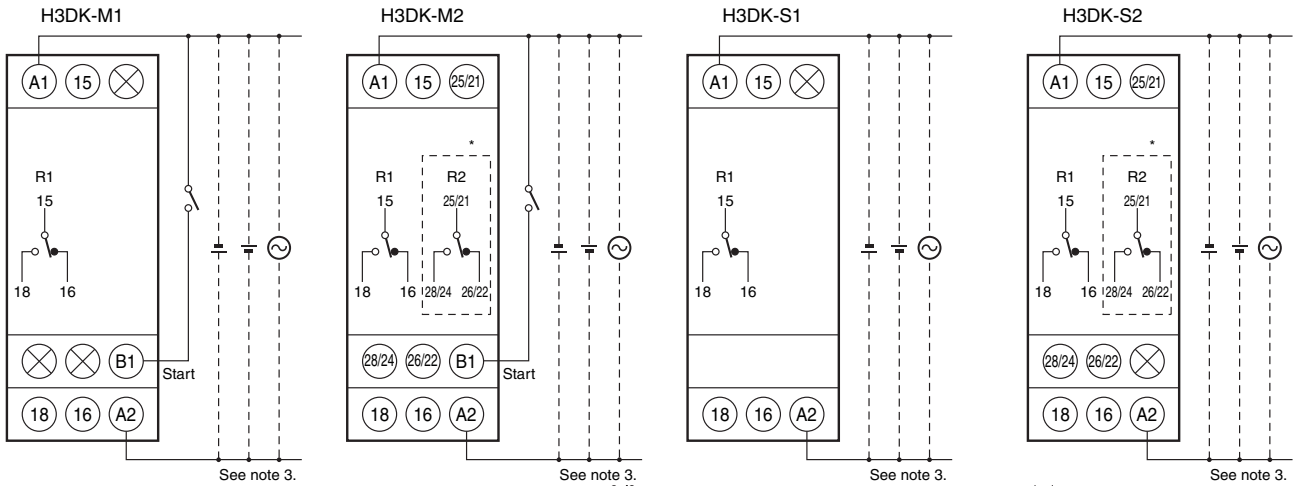

Note 1: The time-limit contact symbol for previous models of Timers was . The time-limit contact symbol for the H3DK is . A different symbol is used because the H3DK supports multiple operating modes.

Note 2: *The relay R2 can be set to either instantaneous or time-limit contacts using the switch on the front of the Timer.

Note 3: The power supply terminals do not have polarity.

(DIN notation)

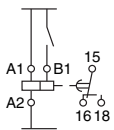

(DIN notation)

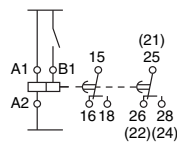

(DIN notation)

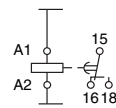

(DIN notation)

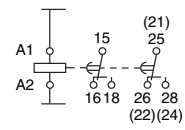

Input Connections

The start input of the H3DK-M1/-M2 is a voltage input.

PNP Transistor Input

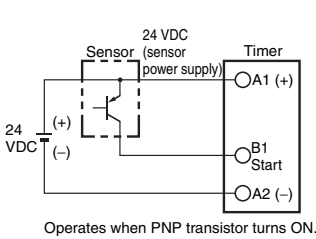

NPN Transistor Input

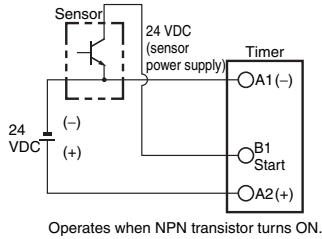

Relay Input

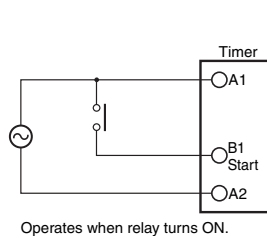

Consider the minimum load of the relay. (See signal levels on the right.)

Voltage Input Signal Levels

Transistor input	1. Transistor ON • Residual voltage: 1 V max. Voltage between terminals B1 and A2 must be equal to or higher than the rated high level voltage (20.4 VDC min.).
	2. Transistor OFF • Leakage current: 0.01 mA max. Voltage between terminals B1 and A2 must be equal to or below the rated low level voltage (2.4 VDC min.).
Relay input	Use relays that can adequately switch 0.1 mA at the imposed voltage. When the relay is ON or OFF, the voltage between terminals B1 and A2 must be within the following ranges: • 24 to 240 VAC/DC When relay is ON: 20.4 to 264 VAC/DC When relay is OFF: 0 to 2.4 V • 12 VDC When relay is ON: 10.8 to 13.2 V When relay is OFF: 0 to 1.2 V

Nomenclature

H3DK-M2 H3DK-S2

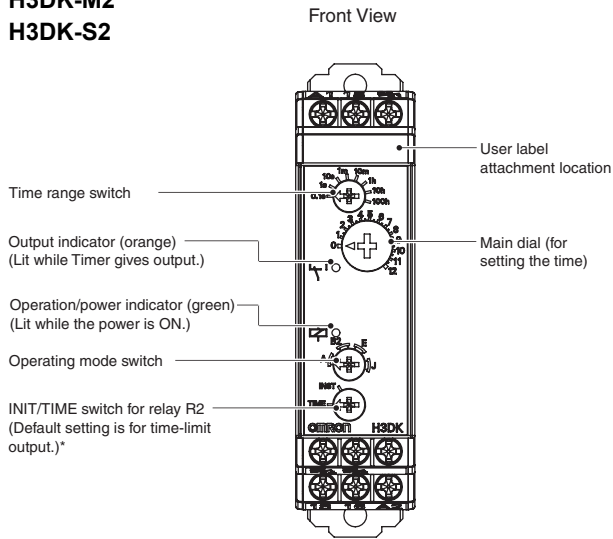

*If the switch is left between settings, proper operation may not be possible. Make sure that the switch is set properly.
Note: The default settings are for 0.1 s in mode A.

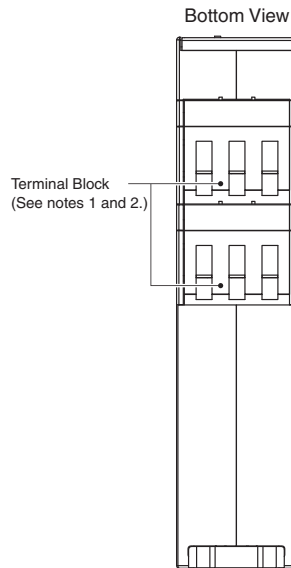

Note 1. Use solid wire (2.5 mm² max.) or ferrules with insulative sleeves to connect to the terminals.
To maintain the withstand voltage after connecting the terminals, insert no more than 8 mm of exposed conductor into the terminal.

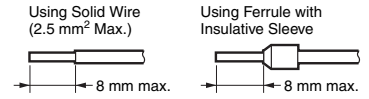

Recommended Ferrules

- Phoenix Contact
- AI□□□ Series
- AI-TWIN□□□ Series

Note 2. Screw Tightening Torque
Recommended torque: 0.49 N·m
Maximum torque: 0.98 N·m

H3DK-M1

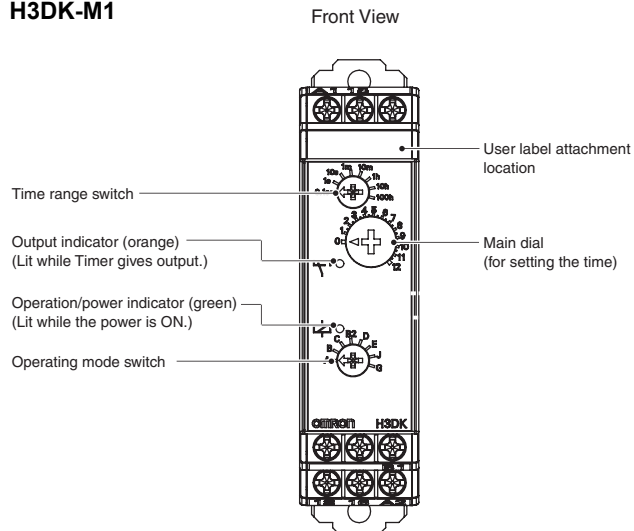

*If the switch is left between settings, proper operation may not be possible. Make sure that the switch is set properly.
Note: The default settings are for 0.1 s in mode A.

H3DK-S1

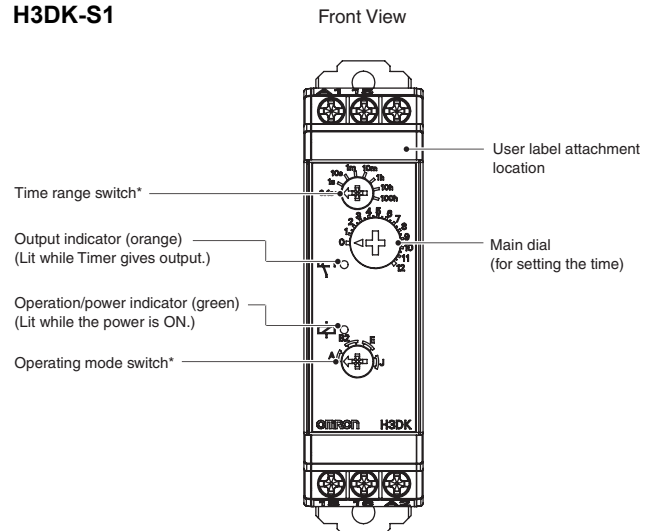

*If the switch is left between settings, proper operation may not be possible. Make sure that the switch is set properly.
Note: The default settings are for 0.1 s in mode A.

H3DK-M/H3DK-S

Dimensions

(Unit: mm)

Timers

H3DK-M
H3DK-S



H3DK-M2
H3DK-S2

H3DK-M1
H3DK-S1

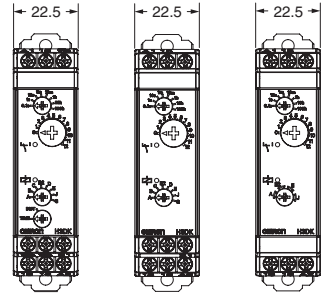

H3DK-M2
H3DK-S2

H3DK-M1

H3DK-S1

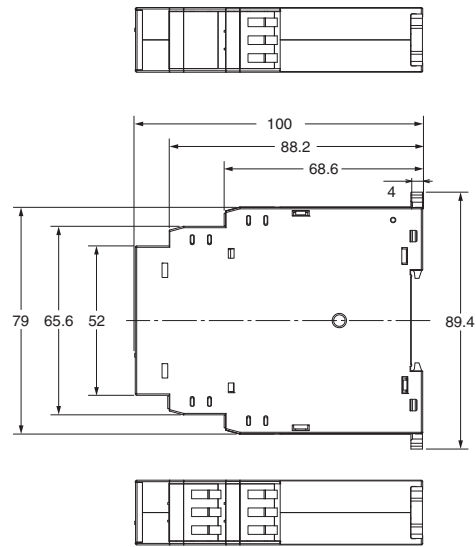

Track Mounting Products (Sold Separately)

Refer to page 28 for details.

Operating Procedures

Basic Operation

Setting Switches

- Each switch has a snap mechanism that secures the switch at given positions. Set the switch to one of these positions. Do not set it midway between two positions. Malfunction could result from an improper setting.

Setting the Operating Mode

Setting the Operating Mode

The H3DK-M can be set to any of eight operating modes. The H3DK-S can be set to any of four operating modes. Turn the operating mode switch with a flat-blade or Phillips screwdriver. The H3DK-M can be set to any of eight modes; the H3DK-S, to any of four modes.

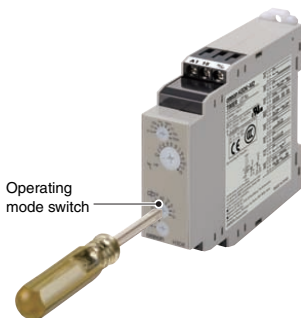

Operating mode switch

Setting the INIT/TIME Switch

Switching Relay R2 between Instantaneous and Time-limit Contacts (H3DK-M2/-S2 Only)

The INIT/TIME switch can be used to switch relay R2 between instantaneous and time-limit operation.



INIT/TIME switch

Setting the Time Range

Setting the Time Range

The time range switch can be used to set the time range. Turn the switch with a flat-blade or Phillips screwdriver.

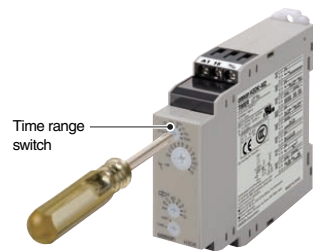

Time range switch

Timing Charts

- There is no start input with the H3DK-S. Timer operation starts when the power is turned ON.
- There is no instantaneous output with the H3DK-□1.

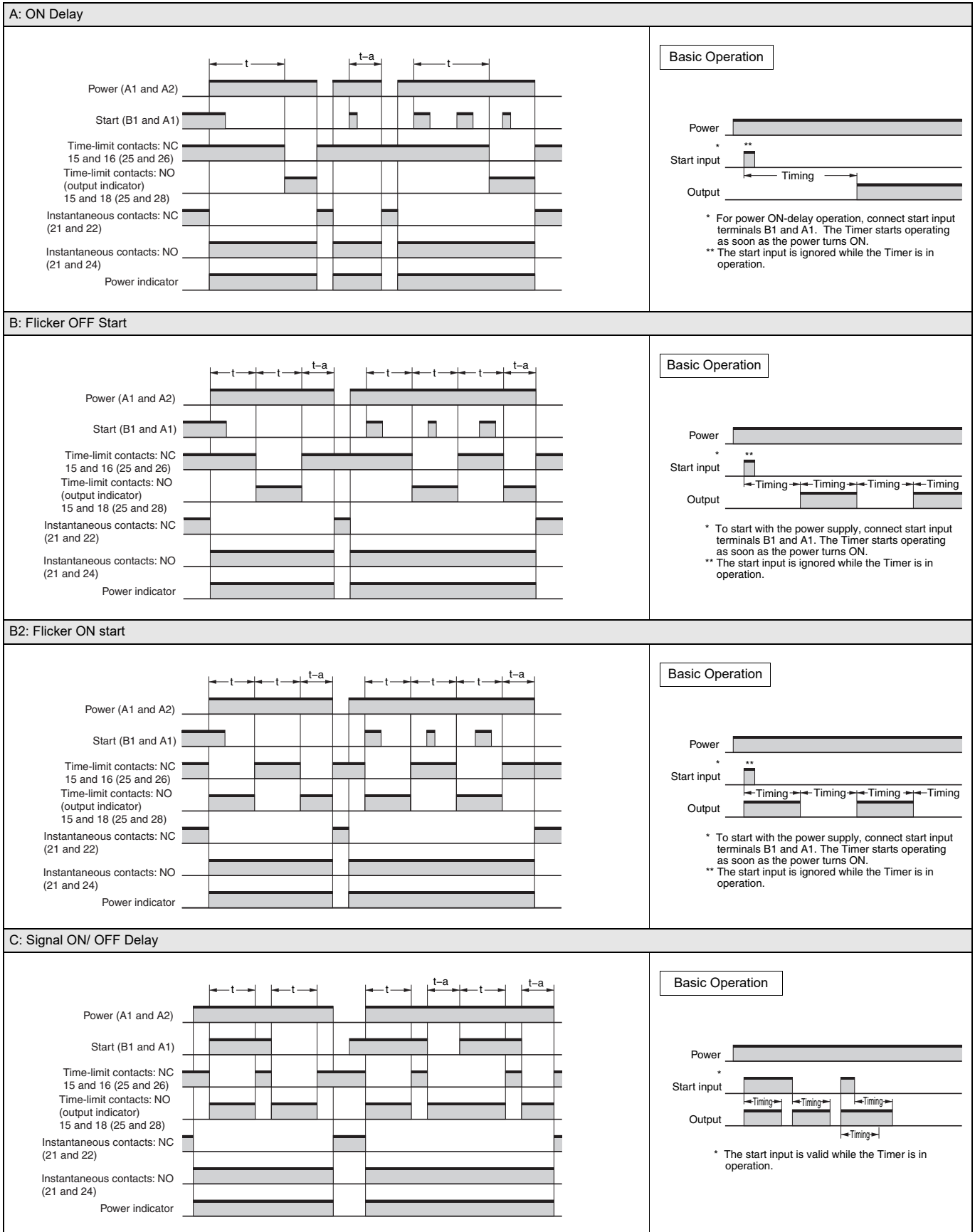

Note 1. The reset time is 0.1 s min. Make sure the signal input time is 0.05 s or longer.
 Note 2. "t" is the set time. "t-a" is a time that is less than the set time.

D: Signal OFF delay

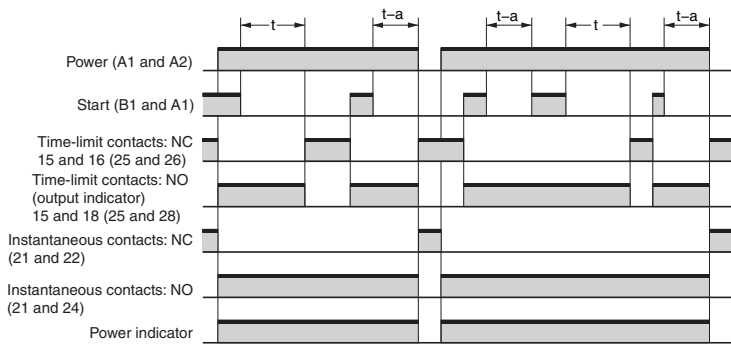

Basic Operation

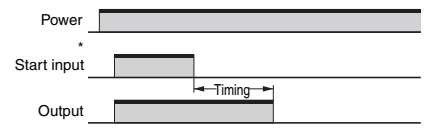

* The start input is valid while the Timer is in operation.

E: Interval

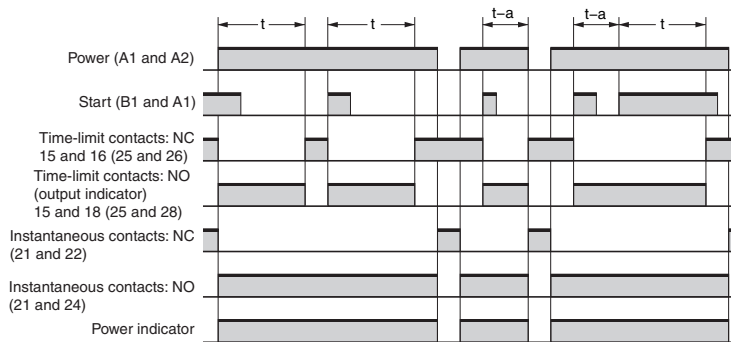

Basic Operation

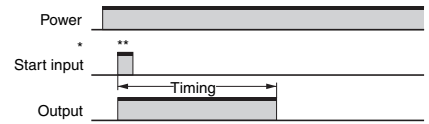

* For power ON-delay operation, connect start input terminals B1 and A1. The Timer starts operating as soon as the power turns ON.
 ** The start input is valid while the Timer is in operation.

G: Signal ON/ OFF Delay

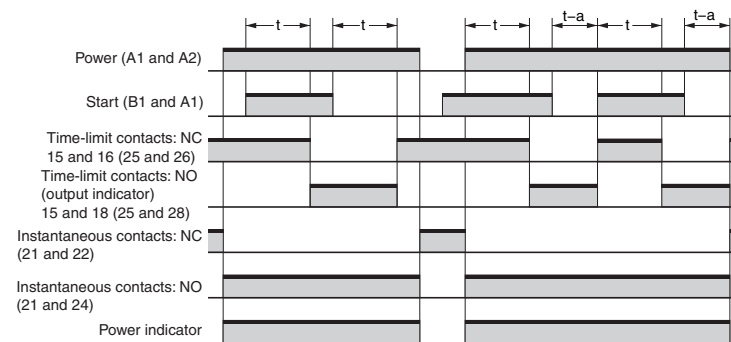

Basic Operation

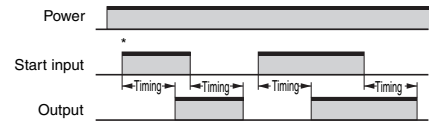

* The start input is valid while the Timer is in operation.

J: One-shot Output (ON delay)

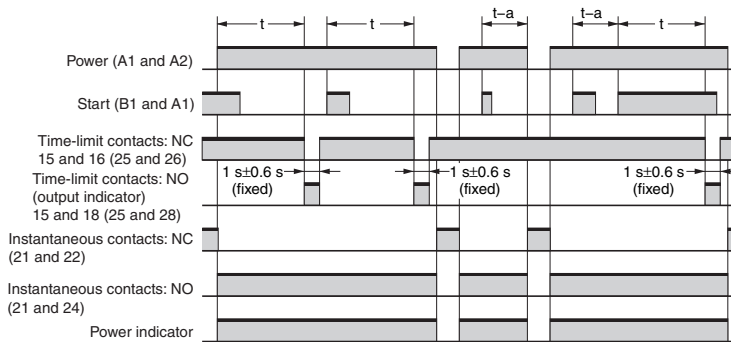

Basic Operation

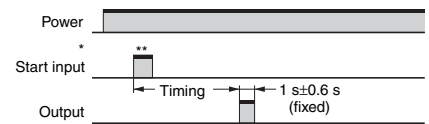

* To start with the power supply, connect start input terminals B1 and A1. The Timer starts operating as soon as the power turns ON.
 ** The start input is valid while the Timer is in operation.

Note 1. The reset time is 0.1 s min. Make sure the signal input time is 0.05 s or longer.
 Note 2. "t" is the set time. "t-a" is a time that is less than the set time.

Twin Timer

H3DK-F

- Switch between flicker-OFF or flicker-ON start mode.
- Independent ON time and OFF time settings.
- Eight time ranges from 0.1 s to 1,200 h.



For the most recent information on models that have been certified for safety standards, refer to your OMRON website.

Ordering Information

List of Models

Operating modes	Supply voltage	Control output	Model	H3DK-F
Flicker OFF start/flicker ON start	24 to 240 VAC/DC	Contact output: SPDT	Model	H3DK-F
	12 VDC	Contact output: SPDT	Model	H3DK-FA

Accessories (Order Separately)

Item	Specification	Model
Mounting Track	50 cm (l) x 7.3 mm (t)	PFP-50N
	1 m (l) x 7.3 mm (t)	PFP-100N
	1 m (l) x 16 mm (t)	PFP-100N2
End Plate	---	PFP-M
Spacer	---	PFP-S

Model Structure

Model	Operating modes	Terminal block	Output type	Mounting method	Safety standards	Accessories
H3DK-F	Flicker OFF start/flicker ON start	6 terminals	Relay, SPDT	DIN Track mounting	cURus (UL508) CSA C22.2 No. 14) EN 61812-1 IEC 60664-1 4 kV/2 EN 50274	User label

Specifications

Time Ranges

Time range setting	0.1 s	1 s	10 s	1 min	10 min	1 h	10 h	100 h
Set time range	0.1 to 1.2 s	1 to 12 s	10 to 120 s	1 to 12 min	10 to 120 min	1 to 12 h	10 to 120 h	100 to 1,200 h
Scale numbers	12							

Note: When the main dial is set to "0" for all settings, the output will operate instantaneously.

Ratings

Power supply voltage *1	• 24 to 240 VAC/DC, 50/60 Hz *2 • 12 VDC *2
Allowable voltage fluctuation range	• 24 to 240 VAC/DC: 85% to 110% of rated voltage • 12 VDC: 90% to 110% of rated voltage
Power reset	Minimum power-OFF time: 0.1 s
Reset voltage	10% of rated voltage
Power consumption	H3DK-F At 240 VAC: 4.5VA max. *3
	H3DK-FA At 12 VDC: 0.6 W max.
Control output	Contact output: 5 A at 250 VAC with resistive load (cosφ = 1), 5 A at 30 VDC with resistive load *4, 0.15 A max. at 125 VDC with resistive load, 0.1 A at 125 VDC with L/R of 7 ms. The minimum applicable load is 10 mA at 5 VDC (P reference value). Contact materials : Ag-alloy + Gold plating

Ambient operating temperature	-20 to 55°C (with no icing)
Storage temperature	-40 to 70°C (with no icing)
Ambient operating humidity	25% to 85%

- *1. When using a 24-VDC power supply voltage, there will be an inrush current of approximately 0.25 A. Allow for this inrush current when turning ON and OFF the power supply to the Timer with device with a solid-state output, such as a sensor.
- *2. DC ripple: 20% max.
- *3. Refer to *DC Power Consumptions (Reference Information)* on page 27 for DC power consumptions.
- *4. The control output ratings are for one H3DK operating alone. If you operate two or more Timers side by side, refer to *Installation Pitch and Output Switching Capacity (Reference Values)* on the next page.

■ Characteristics

Accuracy of operating time	±1% of FS max. (±1% ±10 ms max. at 1.2-s range)	
Setting error	±10% of FS ±0.05 s max.	
Influence of voltage	±0.5% of FS max. (±0.5% ±10 ms max. at 1.2-s range)	
Influence of temperature	±2% of FS max. (±2% ±10 ms max. at 1.2-s range)	
Insulation resistance	100 MΩ min. at 500 VDC	
Dielectric strength	Between current-carrying metal parts and exposed non-current-carrying metal parts: 2,000 VAC 50/60 Hz for 1 min. Between control output terminals and operating circuit: 2,000 VAC 50/60 Hz for 1 min. Between contacts not located next to each other: 1,000 VAC 50/60 Hz for 1 min.	
Impulse withstand voltage	24 to 240 VAC/VDC: 5 kV between power terminals, 5 kV between current-carrying metal parts and exposed non-current-carrying metal parts 12 VDC: 1 kV between power terminals, 1.5 kV between current-carrying metal parts and exposed non-current-carrying metal parts	
Noise immunity	Square-wave noise generated by noise simulator (pulse width: 100 ns/1 μs, 1-ns rise): ±1.5 kV	
Static immunity	Malfunction: 4 kV, Destruction: 8 kV	
Vibration resistance	Destruction	0.75-mm single amplitude at 10 to 55 Hz for 2 h each in 3 directions
	Malfunction	0.5-mm single amplitude at 10 to 55 Hz for 10 min each in 3 directions
Shock resistance	Destruction	1,000 m/s ² 3 times each in 6 directions
	Malfunction	100 m/s ² 3 times each in 6 directions
Life expectancy	Mechanical	10 million operations min. (under no load at 1,800 operations/h)
	Electrical	100,000 operations min. (5 A at 250 VAC, resistive load at 360 operations/h)
Degree of protection	IP30 (Terminal block: IP20)	
Weight	Approx. 110 g	

■ Applicable standards

Safety standards	cURus: UL 508/CSA C22.2 No. 14 EN 50274: Finger protection, back-of-hand proof EN 61812-1: Pollution degree 2, Overvoltage category III CCC: GB/T 14048.5 Pollution degree 2, Overvoltage category III * LR: Test Specification No. 1-2002 Category ENV 1.2	
EMC	(EMI) Radiated Emissions: Emission AC Mains: Harmonic Current: Voltage Fluctuations and Flicker: (EMS) Immunity ESD: Immunity RF-interference: Immunity Burst: Immunity Surge: Immunity Conducted Disturbance: Immunity Voltage Dip/Interruption:	EN61812-1 EN 55011 class B EN 55011 class B EN 61000-3-2 EN61000-3-3 EN61812-1 IEC61000-4-2 IEC61000-4-3 IEC61000-4-4 IEC61000-4-5 IEC61000-4-6 IEC61000-4-11

* CCC certification requirements

Recommended fuse	0216005 (250 VAC, 5 A) manufactured by Littelfuse
Rated operating voltage Ue	AC-15: Ue: 250 VAC, Ie: 3 A
Rated operating current Ie	AC-13: Ue: 250 VAC, Ie: 5 A DC-13: Ue: 30 VDC, Ie: 0.1 A
Rated insulation voltage	250 V
Rated impulse withstand voltage (altitude: 2,000 m max.)	4 kV (at 240 VAC)
Conditional short-circuit current	1,000 A

● Installation Pitch and Output Switching Capacity (Reference Values)

The relation between the installation pitch and the load current is shown in the following graph. (Except for the H3DK-GE)
If Timer is used under load conditions that exceed the specified values, the temperature inside the Timer will increase, reducing the life expectancy of internal parts.

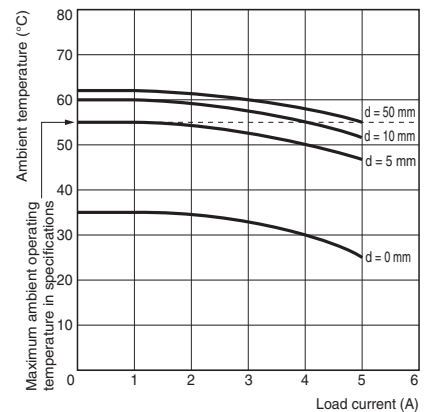

Testing Method

Tested Timer: H3DK-F
Applied voltage: 240 VAC
Installation pitch: 0, 5, 10, and 50 mm

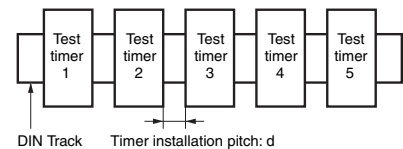

Connections

Block Diagrams

H3DK-F

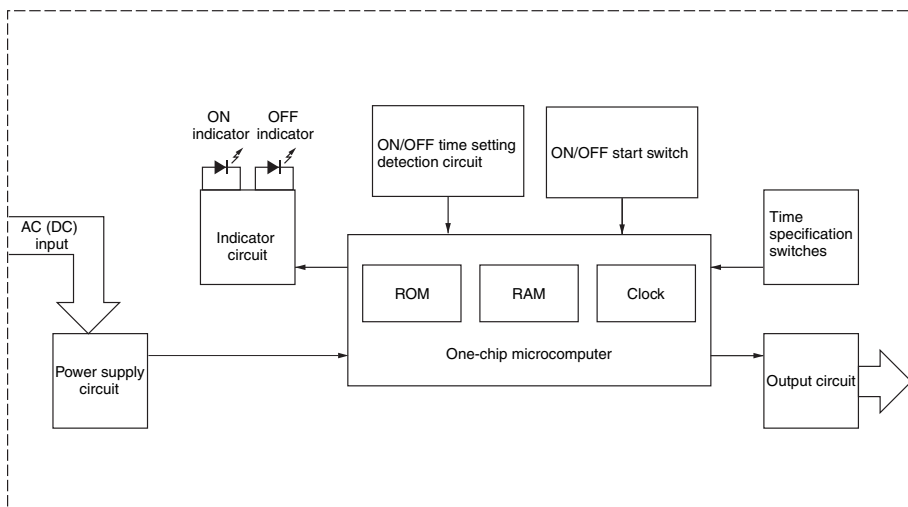

Terminal Arrangement

H3DK-F

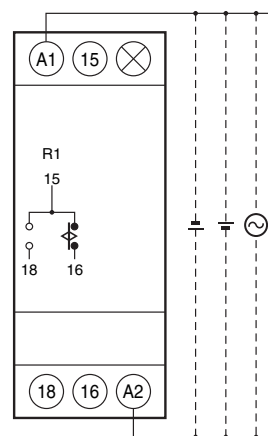

(DIN notation)

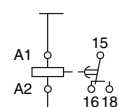

Note: The power supply terminals do not have polarity.

Nomenclature

H3DK-F

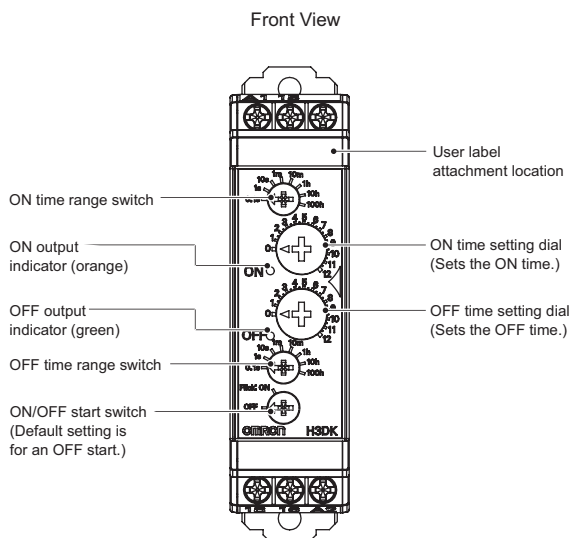

Note: If the switch is left between settings, proper operation may not be possible. Make sure that the switch is set properly.

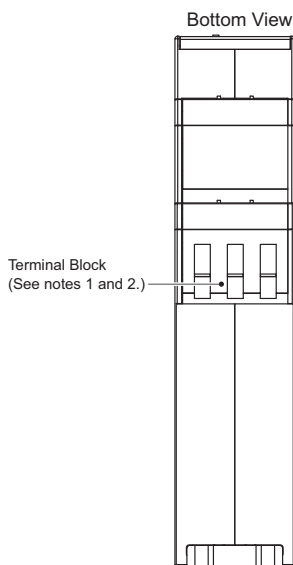

Note 1. Use solid wire (2.5 mm² max.) or ferrules with insulative sleeves to connect to the terminals. To maintain the withstand voltage after connecting the terminals, insert no more than 8 mm of exposed conductor into the terminal.

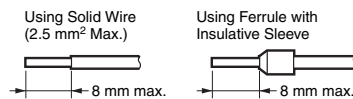

Recommended Ferrules
Phoenix Contact
• AI□□□ Series
• AI-TWIN□□□ Series

Note 2. Screw Tightening Torque
Recommended torque: 0.49 N·m
Maximum torque: 0.98 N·m

H3DK-F

Dimensions

(Unit: mm)

Timers

H3DK-F

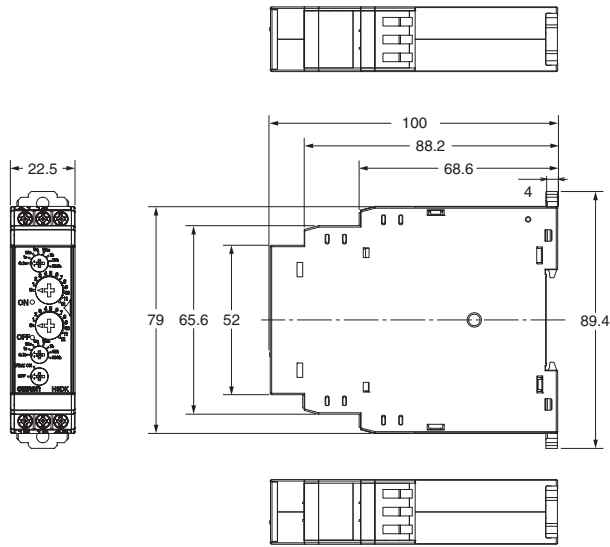

Track Mounting Products (Sold Separately)

Refer to page 28 for details.

Operating Procedures

Basic Operation

Setting Switches

- Each switch has a snap mechanism that secures the switch at given positions. Set the switch to one of these positions. Do not set it midway between two positions. Malfunction could result from an improper setting.

Setting the Time Ranges

Setting the Time Ranges

Use the ON time range switch to set the ON time range and the OFF time range switch to set the OFF time range. Turn the switches with a flat-blade or Phillips screwdriver.

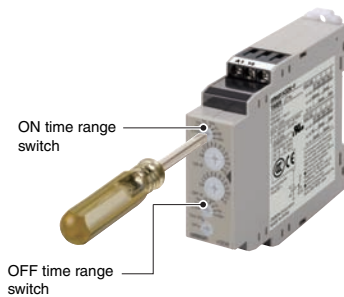

Setting the ON/OFF Start Switch

Setting an ON Start or OFF Start

The ON/OFF start switch can be used to switch between ON-start and OFF-start operation.



Setting the Times

Setting the Times

Use the ON time setting dial and the OFF time setting dial to set the ON time and OFF time.

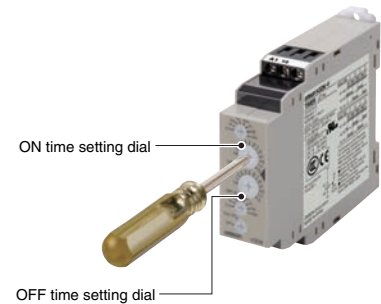

Timing Charts

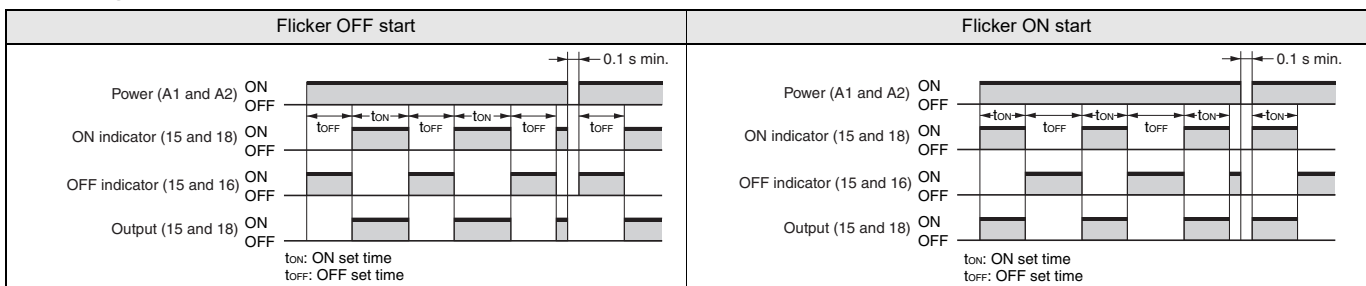

Note 1. The reset time is 0.1 s min.

Note 2. When power is supplied in flicker ON start mode, the OFF indicator lights momentarily. This, however, has no effect on the performance of the Timer.

Star-delta Timer H3DK-G

- Set two time ranges between 1 and 120 s with one Timer.
- Models with 240 to 440-VAC power supply added to series.



For the most recent information on models that have been certified for safety standards, refer to your OMRON website.

Ordering Information

List of Models

Operating modes	Supply voltage	Control output	H3DK-G	
Star-delta Timer	24 to 240 VAC/DC	Contact outputs Delta circuit: SPDT, Star circuit: SPDT	Model	H3DK-G
	12 VDC		Model	H3DK-GA
	240 to 440 VAC		Model	H3DK-GE

Accessories (Order Separately)

Item	Specification	Model
Mounting Track	50 cm (l) x 7.3 mm (t)	PFP-50N
	1 m (l) x 7.3 mm (t)	PFP-100N
	1 m (l) x 16 mm (t)	PFP-100N2
End Plate	---	PFP-M
Spacer	---	PFP-S

Model Structure

Model	Terminal block	Operating/resetting method	Output type	Mounting method	Safety standards	Accessories
H3DK-G	9 terminals	Time-limit operation/self-resetting	Time-limit (relay) Star circuit: SPDT Delta circuit: SPDT	DIN Track mounting	cURus ^{*1} (UL 508 CSA C22.2 No. 14) EN 61812-1 IEC 60664-1 4 kV/2 EN 50274	User label

*1. Except for the H3DK-GE.

Specifications

Time Ranges

Time range setting	t1x1	t1x10
Star set time (t1) range	1 to 12 s	10 to 120 s
Star-Delta transfer time (t2)	Select from 0.05, 0.1, 0.25, or 0.5 s.	

Ratings

		H3DK-G, -GA	H3DK-GE
Power supply voltage ^{*1}		• 24 to 240 VAC/DC, 50/60 Hz ^{*2} • 12 VDC ^{*2}	• 240 to 440 VAC (50/60 Hz) ^{*5}
Allowable voltage fluctuation range		• 24 to 240 VAC/DC: 85% to 110% of rated voltage • 12 VDC: 90% to 110% of rated voltage	80 % to 110% of rated voltage
Power reset		Minimum power-OFF time: 0.5 s	
Reset voltage		10% of rated voltage	
Power consumption	H3DK-G	At 240 VAC: 6.6 VA max. ^{*3}	At 440 VAC: 34 VA max.
	H3DK-GA	At 12 VDC: 0.9 W max.	

H3DK-G

	H3DK-G, -GA	H3DK-GE
Control output	Contact output (Time-limit output: relay, Star output: SPDT, Delta output: SPDT): 5 A at 250 VAC with resistive load ($\cos\phi = 1$), 5 A at 30 VDC with resistive load ^{*3, *4} 0.15 A max at 125 VDC with resistive load, 0.1 A at 125 VDC with L/R of 7 ms. The minimum applicable load is 10 mA at 5 VDC (P reference value). Contact materials : Ag-alloy + Gold plating	Contact output: 1th 2 A 1.5 A at 120 VAC with AC-15, 1 A at 240 VAC with AC-15, 0.3 A at 440 VAC with AC-15, Contact materials : Ag-alloy + Gold plating
Ambient operating temperature	-20 to 55°C (with no icing)	
Storage temperature	-40 to 70°C (with no icing)	
Ambient operating humidity	25% to 85%	

*1. When using a 24-VDC power supply voltage, there will be an inrush current of approximately 0.25 A. Allow for this inrush current when turning ON and OFF the power supply to the Timer with device with a solid-state output, such as a sensor.

*2. DC ripple: 20% max.

*3. Refer to *DC Power Consumptions (Reference Information)* on page 27 for DC power consumptions.

*4. The control output ratings are for one H3DK operating alone. If you operate two or more Timers side by side, refer to *Installation Pitch and Output Switching Capacity (Reference Values)* on the next page.

*5. For the H3DK-GE, approx. 6 A of inrush current will flow when the power supply is turned ON. When selecting the device connected to the Timer, allow leeway in the current ratings.

Characteristics

	H3DK-G, -GA	H3DK-GE
Accuracy of operating time	±1% of FS max.	
Setting error	±10% of FS ±0.05 s max.	
Transfer time	Total error ± (25% of transfer time + 5 ms) max.	
Influence of voltage	±0.5% of FS max.	
Influence of temperature	±2% of FS max.	
Insulation resistance	100 MΩ min. at 500 VDC	
Dielectric strength	Between current-carrying metal parts and exposed non-current-carrying metal parts: 2,000 VAC 50/60 Hz for 1 min. Between control output terminals and operating circuit: 2,000 VAC 50/60 Hz for 1 min. Between contacts not located next to each other: 1,000 VAC 50/60 Hz for 1 min.	Between current-carrying metal parts and exposed non-current-carrying metal parts: 2,500 VAC 50/60 Hz for 1 min. Between control output terminals and operating circuit: 2,500 VAC 50/60 Hz for 1 min. Between contacts not located next to each other: 1,000 VAC 50/60 Hz for 1 min.
Impulse withstand voltage	H3DK-G: 24 to 240 VAC/VDC: 5 kV between power terminals, 5 kV between current-carrying metal parts and exposed non-current-carrying metal parts H3DK-GA: 12 VDC: 1 kV between power terminals, 1.5 kV between current-carrying metal parts and exposed non-current-carrying metal parts	H3DK-GE: 240 to 440 VAC: 7.5 kV between power terminals, 7.5 kV between current-carrying metal parts and exposed non-current-carrying metal parts.
Noise immunity	Square-wave noise generated by noise simulator (pulse width: 100 ns/1 μs, 1-ns rise): ±1.5 kV*	
Static immunity	Malfunction: 4 kV, Destruction: 8 kV	
Vibration resistance	Destruction	0.75-mm single amplitude at 10 to 55 Hz for 2 h each in 3 directions
	Malfunction	0.5-mm single amplitude at 10 to 55 Hz for 10 min each in 3 directions
Shock resistance	Destruction	1,000 m/s ² 3 times each in 6 directions
	Malfunction	100 m/s ² 3 times each in 6 directions
Life expectancy	Mechanical	10 million operations min. (under no load at 1,800 operations/h)
	Electrical	100,000 operations min. (5 A at 250 VAC, resistive load at 360 operations/h)
Degree of protection	IP30 (Terminal block: IP20)	
Weight	Approx. 120 g	

* Except for the H3DK-GE

Installation Pitch and Output Switching Capacity (Reference Values)

The relation between the installation pitch and the load current is shown in the following graph. (Except for the H3DK-GE) If Timer is used under load conditions that exceed the specified values, the temperature inside the Timer will increase, reducing the life expectancy of internal parts.

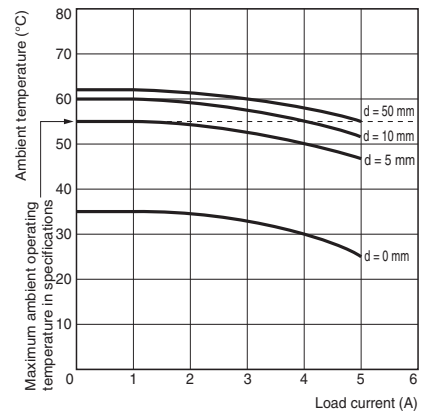

Testing Method

Tested Timer: H3DK-G
Applied voltage: 240 VAC
Installation pitch: 0, 5, 10, and 50 mm

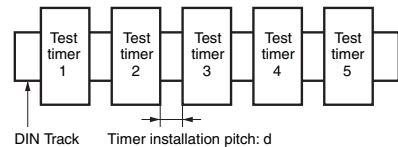

Applicable standards

Safety standards	cURus: UL 508/CSA C22.2 No. 14 ^{*1} EN 50274: Finger protection, back-of-hand proof EN 61812-1: Pollution degree 2, Overvoltage category III ^{*2} CCC: GB/T 14048.5 Pollution degree 2, Overvoltage category III ^{*3} LR: Test Specification No. 1-2002 Category ENV 1.2 ^{*1}
EMC	(EMI) Radiated Emissions: EN61812-1 EN 55011 class B Emission AC Mains: EN 55011 class B Harmonic Current: EN 61000-3-2 ^{*1} Voltage Fluctuations and Flicker: EN61000-3-3 ^{*1} (EMS) Immunity ESD: EN61812-1 IEC61000-4-2 Immunity RF-interference: IEC61000-4-3 Immunity Burst: IEC61000-4-4 Immunity Surge: IEC61000-4-5 Immunity Conducted Disturbance: IEC61000-4-6 Immunity Voltage Dip/Interruption: IEC61000-4-11

- *1. This standard is not applicable to the H3DK-GE.
- *2. This standard is not applicable if the output is used with a rating that exceeds 250 VAC.
- *3. CCC certification requirements

Recommended fuse	0216005 (250 VAC, 5 A) manufactured by Littelfuse
Rated operating voltage Ue Rated operating current Ie	AC-15: Ue: 250 VAC, Ie: 3 A AC-13: Ue: 250 VAC, Ie: 5 A DC-13: Ue: 30 VDC, Ie: 0.1 A
Rated insulation voltage	250 V
Rated impulse withstand voltage (altitude: 2,000 m max.)	4 kV (at 240 VAC)
Conditional short-circuit current	1,000 A

Connections

Block Diagrams
H3DK-G

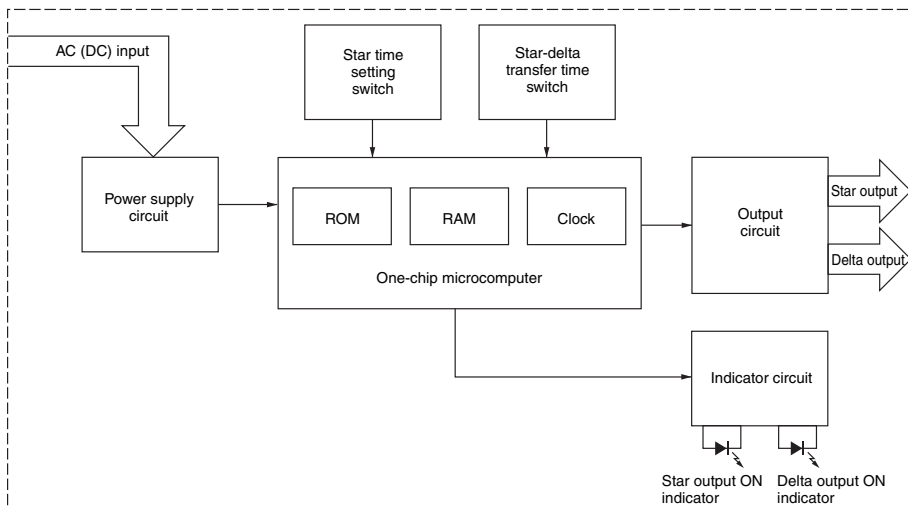

Terminal Arrangement
H3DK-G

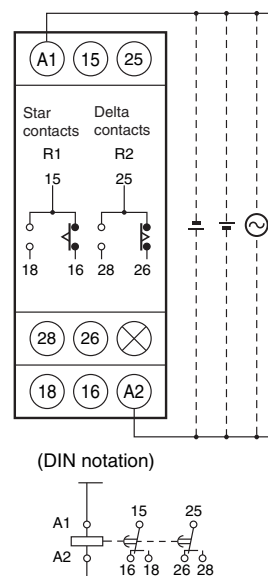

Note: The power supply terminals do not have polarity.

H3DK-G

Nomenclature

H3DK-G

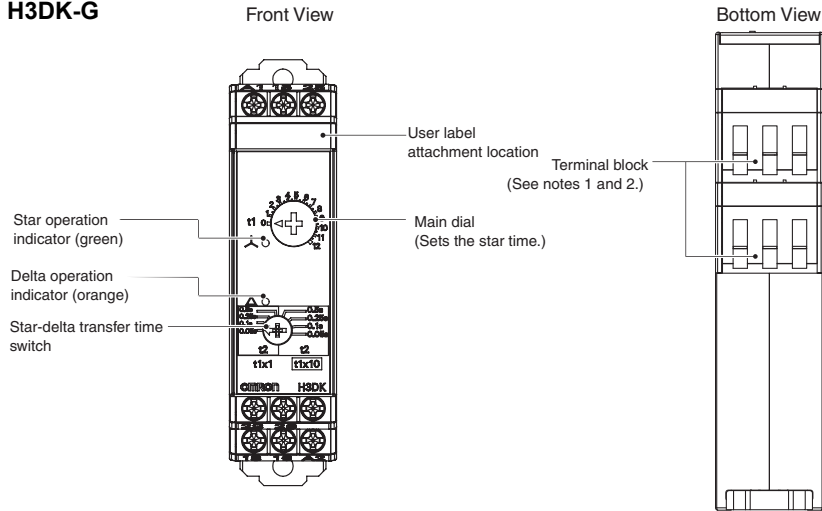

Note 1. Use solid wire (2.5 mm² max.) or ferrules with insulative sleeves to connect to the terminals.
To maintain the withstand voltage after connecting the terminals, insert no more than 8 mm of exposed conductor into the terminal.

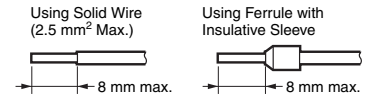

Recommended Ferrules
Phoenix Contact
• AI□□□ Series
• AI-TWIN□□□ Series

Note 2. Screw Tightening Torque
Recommended torque: 0.49 N·m
Maximum torque: 0.98 N·m

Note 3. Always keep the front cover mounted when using the Timer.

H3DK-GE

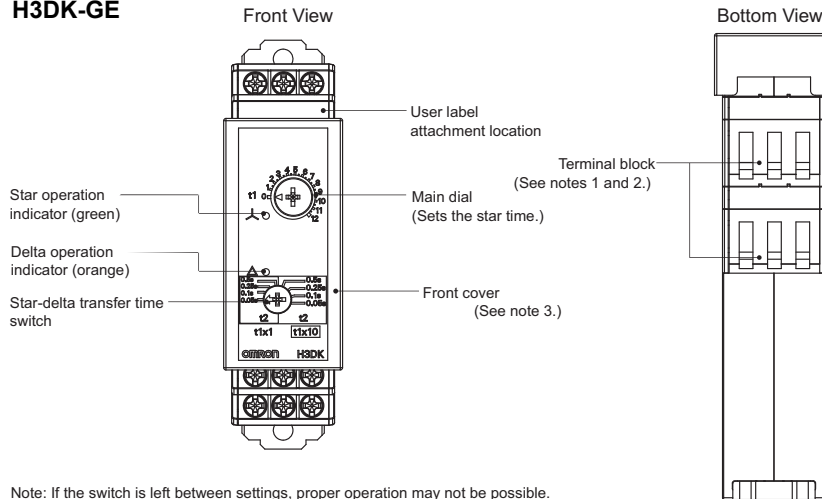

Note: If the switch is left between settings, proper operation may not be possible.
Make sure that the switch is set properly.

Dimensions

■ Timers

H3DK-G

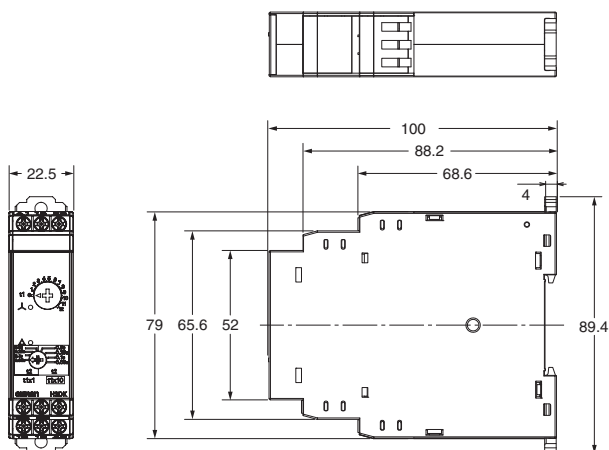

H3DK-GE

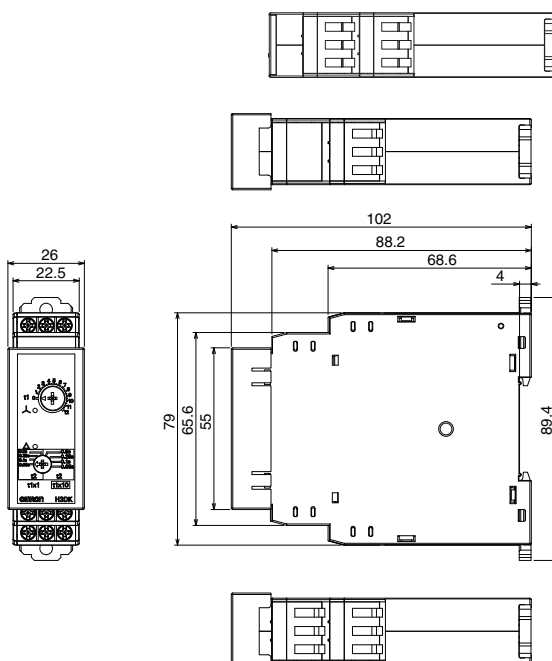

■ Track Mounting Products (Sold Separately)

Refer to page 28 for details.

H3DK-G

Operating Procedures

Basic Operation

Setting Switches

- Each switch has a snap mechanism that secures the switch at given positions. Set the switch to one of these positions. Do not set it midway between two positions. Malfunction could result from an improper setting.

Setting the Time Ranges

Setting the Delta Time Range and the Star-delta Transfer Time (t2)

Star Time (t1) Range

Set the star-delta transfer time.

For $\times 1$ (1 to 12 s), use side (A) (labeled "t1 $\times 1$ ").

For $\times 10$ (10 to 120 s), use side (B) (labeled "t1 $\times 10$ ").

(See following diagram.)

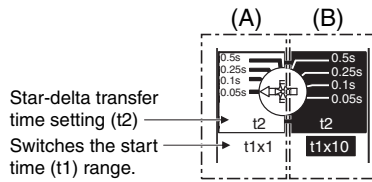

Setting the Time

Setting the Time

The start time is set with the main dial.

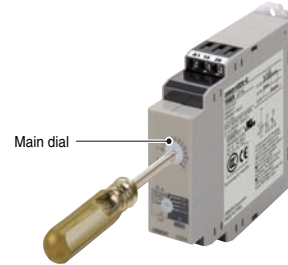

Timing Chart

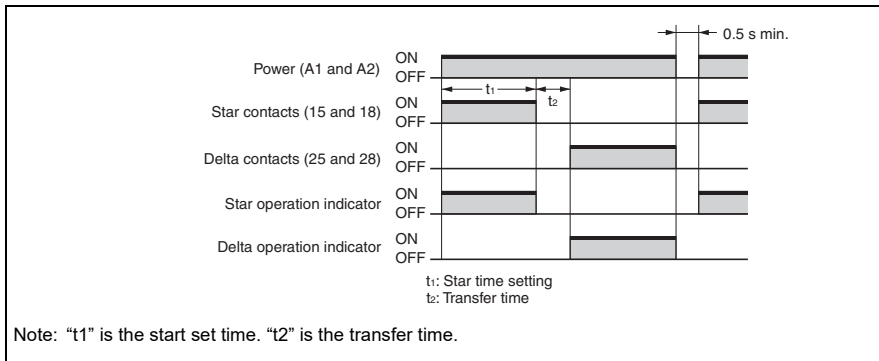

Power OFF-delay Timer H3DK-H

- Set two time ranges with each Timer, from 0.1 to 12 seconds for the S Series and from 1.0 to 120 seconds for the L Series.



Ordering Information

List of Models

				H3DK-H	
Operating modes		Supply voltage	Control output	S Series (time range: 0.1 to 12 s)	L Series (time range: 1.0 to 120 s)
Power OFF Delay	100 to 120 VAC	Contact output: SPDT	Model	H3DK-HCS	H3DK-HCL
	200 to 240 VAC	Contact output: SPDT	Model	H3DK-HDS	H3DK-HDL
	24 to 48 VAC/DC	Contact output: SPDT	Model	H3DK-HBS	H3DK-HBL

Accessories (Order Separately)

Item	Specification	Model
Mounting Track	50 cm (l) x 7.3 mm (t)	PPF-50N
	1 m (l) x 7.3 mm (t)	PPF-100N
	1 m (l) x 16 mm (t)	PPF-100N2
End Plate	---	PPF-M
Spacer	---	PPF-S

Model Structure

Model	Terminal block	Operating/resetting method	Output type	Mounting method	Safety standards	Accessories
H3DK-H	6 terminals	Instantaneous operation/ time-limit reset	Relay, SPDT	DIN Track mounting	cURus (UL 508 CSA C22.2 No. 14) EN 61812-1 IEC 60664-1 4 kV/2 EN 50274	User label

Specifications

Time Ranges

Time range setting	S Series		L Series	
	x0.1	x1	x1	x10
Set time range	0.1 to 1.2 s	1 to 12 s	1 to 12 s	10 to 120 s
Power ON time	0.1 s min.		0.3 s min.	
Scale numbers	12			

Note: The Timer will not operate if the specified power-on time is not kept. Be sure to supply power for at least the period specified. Also, make sure that the repeat cycle for the timing-out operation is at least 3 s.

Ratings

Supply voltage	<ul style="list-style-type: none"> • 100 to 120 VAC, 50/60 Hz • 200 to 240 VAC, 50/60 Hz • 24 to 48 VAC/DC, 50/60 Hz ^{*1} 	
Allowable voltage fluctuation range	85% to 110% of rated voltage	
Power consumption	H3DK-HCS/-HCL	At 120 VAC: 11.7 VA max.
	H3DK-HDS/-HDL	At 240 VAC: 29.5 VA max.
	H3DK-HBS/-HBL	At 48 VAC: 1.2 VA max. ^{*2}
Control output	Contact output, 5 A at 250 VAC with resistive load (cosφ = 1), 5 A at 30 VDC with resistive load ^{*2} The minimum applicable load is 100 mA at 5 VDC (Preference level). Contact materials : Ag-alloy	
Ambient operating temperature	-20 to 55°C (with no icing)	
Storage temperature	-40 to 70°C (with no icing)	
Ambient operating humidity	25% to 85%	

H3DK-H

- *1. DC ripple: 20% max. (A single-phase, full-wave rectifying power supply can be connected.)
- *2. Refer to *DC Power Consumptions (Reference Information)* on page 27 for DC power consumptions.
- *3. The control output ratings are for one H3DK operating alone.
If you operate two or more Timers side by side, refer to *Installation Pitch and Output Switching Capacity (Reference Values)* on the next page.

■ Characteristics

Accuracy of operating time	±1% of FS max. (±1% ±10 ms max. at 1.2-s range)	
Setting error	±10% of FS ±0.05 s max.	
Influence of voltage	±0.5% of FS max. (±0.5% ±10 ms max. at 1.2-s range)	
Influence of temperature	±2% of FS max. (±2% ±10 ms max. at 1.2-s range)	
Insulation resistance	100 MΩ min. at 500 VDC	
Dielectric strength	Between current-carrying metal parts and exposed non-current-carrying metal parts: 2,000 VAC 50/60 Hz for 1 min. Between control output terminals and operating circuit: 2,000 VAC 50/60 Hz for 1 min. Between contacts not located next to each other: 1,000 VAC 50/60 Hz for 1 min.	
Impulse withstand voltage	Between power supply terminals: 1 kV for 24-VAC/DC and 48-VAC/DC models, 5 kV for all other models. Between current-carrying metal parts and exposed non-current-carrying metal parts: 1.5 kV for 24-VAC/DC and 48-VAC/DC models, 5 kV for all other models.	
Noise immunity	Square-wave noise generated by noise simulator (pulse width: 100 ns/1 μs, 1-ns rise): ±1.5 kV (between power supply terminals)	
Static immunity	Malfunction: 4 kV, Destruction: 8 kV	
Vibration resistance	Destruction	0.75-mm single amplitude at 10 to 55 Hz for 2 h each in 3 directions
	Malfunction	0.5-mm single amplitude at 10 to 55 Hz for 10 min each in 3 directions
Shock resistance	Destruction	1,000 m/s ² 3 times each in 6 directions
	Malfunction	100 m/s ² 3 times each in 6 directions
Life expectancy	Mechanical	10 million operations min. (under no load at 1,200 operations/h)
	Electrical	100,000 operations min. (5 A at 250 VAC, resistive load at 1,200 operations/h)
Degree of protection	IP30 (Terminal block: IP20)	
Weight	Approx. 120 g	

■ Applicable standards

Safety standards	cURus: UL 508/CSA C22.2 No. 14 EN 50274: Finger protection, back-of-hand proof EN 61812-1: Pollution degree 2, Overvoltage category III CCC: GB/T 14048.5 Pollution degree 2, Overvoltage category III * LR: Test Specification No. 1-2002 Category ENV 1.2
EMC	(EMI)EN61812-1 Radiated Emissions:EN 55011 class B Emission AC Mains:EN 55011 class B Harmonic Current:EN 61000-3-2 Voltage Fluctuations and Flicker:EN61000-3-3 (EMS)EN61812-1 Immunity ESD: IEC61000-4-2 Immunity RF-interference: IEC61000-4-3 Immunity Burst: IEC61000-4-4 Immunity Surge: IEC61000-4-5 Immunity Conducted Disturbance: IEC61000-4-6 Immunity Voltage Dip/Interruption: IEC61000-4-11

* CCC certification requirements

Recommended fuse	0216005 (250 VAC, 5 A) manufactured by Littelfuse
Rated operating voltage Ue Rated operating current Ie	AC-15: Ue: 250 VAC, Ie: 3 A AC-13: Ue: 250 VAC, Ie: 5 A DC-13: Ue: 30 VDC, Ie: 0.1 A
Rated insulation voltage	250 V
Rated impulse withstand voltage (altitude: 2,000 m max.)	4 kV (at 240 VAC)
Conditional short-circuit current	1,000 A

● Installation Pitch and Output Switching Capacity (Reference Values)

The relation between the installation pitch and the load current is shown in the following graph. (Except for the H3DK-GE)
If Timer is used under load conditions that exceed the specified values, the temperature inside the Timer will increase, reducing the life expectancy of internal parts.

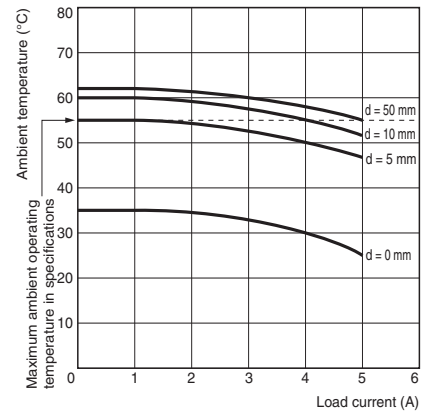

Testing Method

Tested Timer: H3DK-H
Applied voltage: 240 VAC
Installation pitch: 0, 5, 10, and 50 mm

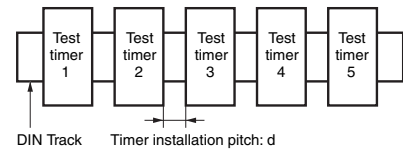

Connections

Block Diagrams

H3DK-H

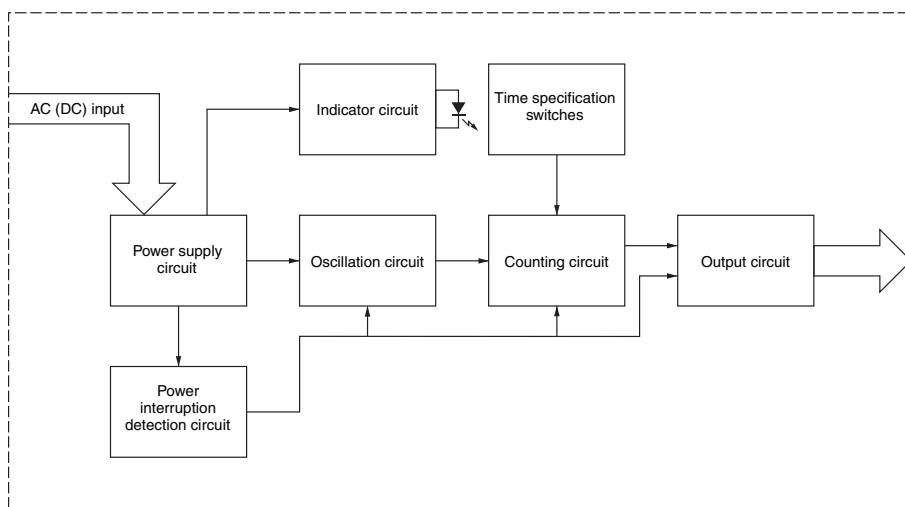

Terminal Arrangement

H3DK-H

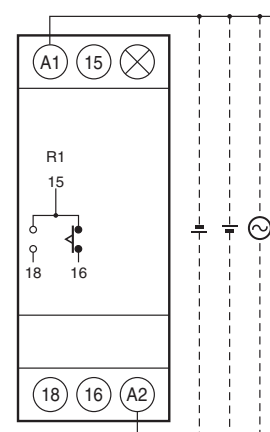

(DIN notation)

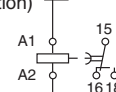

Note 1: The above figure shows the terminal arrangement for a 24 to 48-VAC/DC model. Models with 100 to 120-VAC or 200 to 240-VAC power input do not have a DC input.

Note 2: The power supply terminals do not have polarity.

Nomenclature

H3DK-H

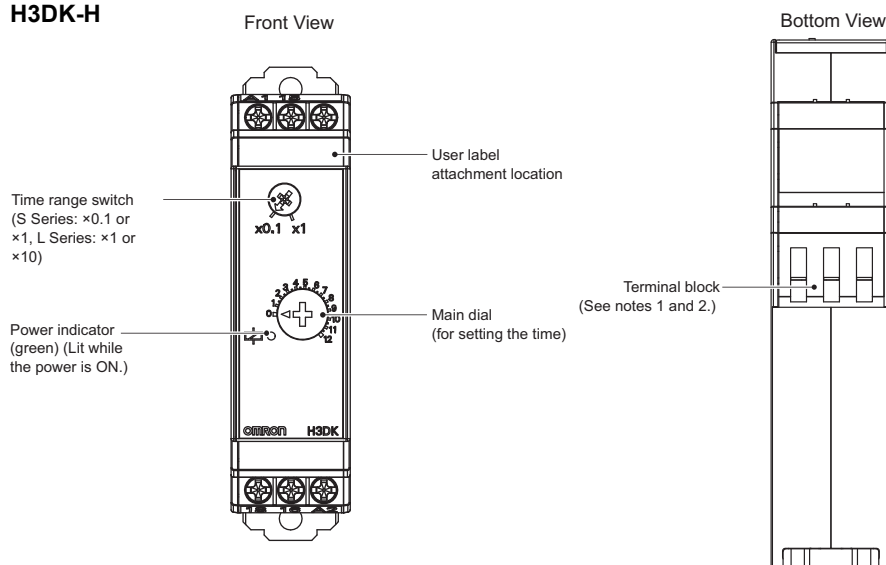

Note: If the switch is left between settings, proper operation may not be possible. Make sure that the switch is set properly.

Note 1. Use solid wire (2.5 mm² max.) or ferrules with insulative sleeves to connect to the terminals.

To maintain the withstand voltage after connecting the terminals, insert no more than 8 mm of exposed conductor into the terminal.

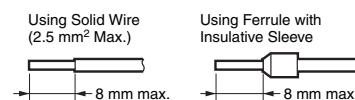

Recommended Ferrules

- Phoenix Contact
- AI□□□ Series
- AI-TWIN□□□ Series

Note 2. Screw Tightening Torque
Recommended torque: 0.49 N·m
Maximum torque: 0.98 N·m

H3DK-H

Dimensions

(Unit: mm)

Timers

H3DK-H

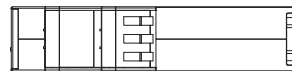
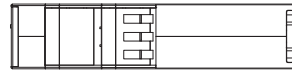
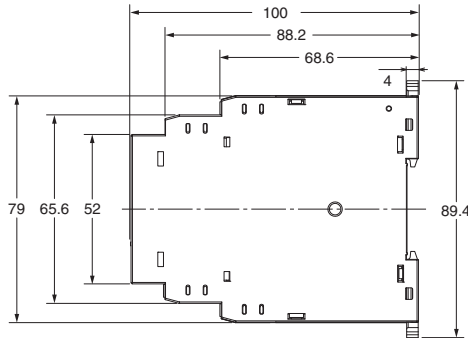
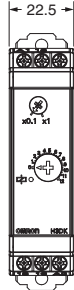

Track Mounting Products (Sold Separately)

Refer to page 28 for details.

Operating Procedures

Basic Operation

Setting Switches

- Each switch has a snap mechanism that secures the switch at given positions. Set the switch to one of these positions. Do not set it midway between two positions. Malfunction could result from an improper setting.

Setting the Time Ranges

Setting the Time Ranges

The scale multiplier can be changed with the timer range switch. It can be changed between $\times 0.1$ s and $\times 1$ s for an S-series Timer and between $\times 1$ s and $\times 10$ s for an L-series Timer.

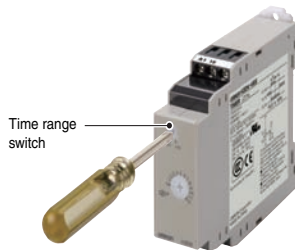

Setting the Time

Setting the Time

The operation time is set with the main dial.



Timing Charts

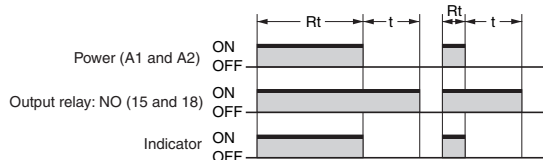

t: Set time

Rt: Minimum power-ON time { S Series: 0.1 s min.
L Series: 0.3 s min.

(The output may never turn ON if the power is not ON for at least this time.)

Safety Precautions

● Refer to Safety Precautions for All Timers.

Note: The following is common for all H3DK models.

Caution

Switching arcs or relay heating may cause fire or explosion. Do not use the Timer in the presence of inflammable or explosive gases.



The H3DK Series uses a transformerless power supply system. An electrical shock may occur if an input terminal is touched while power is being supplied.



The inrush current will depend on the type of load and may influence the contact switching frequency and number of operations. Check both the rated current and the inrush current, and allow leeway in the circuit design.



The life of the output relay largely depends on the switching current and other switch conditions. Consider the actual application conditions and do not exceed the rated load or electrical life. If the output relay is used beyond its service life, the contacts may fuse or burning may occur. Also, never exceed the rated load current. When using a heater, also place a thermal switch in the load circuit.



Do not remove the external case.



Minor electric shock, fire, or equipment failure may sometimes occur. Do not disassemble, modify, or repair the Timer or touch any internal parts.



Precautions for Safe Use

- Use ferrules to wire the H3DK. If stranded wires are used, wire scraps may enter the Timer, possibly shorting the circuits.
- Rapid changes in temperature or high humidity may cause condensation in Timer circuits, possibly resulting in malfunction or damage to components. Check the application environment.
- Store the Timer within the rated ranges given for the Timer model you are using. If the Timer is stored below -20°C , allow it to warm up for three hours at room temperature before turning ON the power supply.
- Use the Timer within the ambient operating temperature and ambient operating humidity ranges given for the Timer model you are using.
- Use the Timer within the characteristics for water and oil exposure given for the Timer model you are using.
- Do not use the Timer in locations subject to excessive dust, corrosive gas, or direct sunlight.
- Do not use the Timer in locations subject to vibration and shock. Long-term exposure may damage the Timer due to stress.
- Separate the Timer from any sources of excessive static electricity, such as forming materials and pipes carrying power or liquid materials.
- Maintain the variations in the power supply voltage to within the specified allowable range.
- If a voltage that exceeds the rating is applied, internal components may be destroyed.
- Wire all terminals correctly.
- Use only the specified wires for wiring.
Applicable wire gauge: AWG18 to AWG22 (for stranded wire)
- Install and clearly label a switch or circuit breaker so that the operator can quickly turn OFF the power supply.
- If the Timer is left in the timed out condition for a long period of time at high temperatures, internal components (such as electrolytic capacitors) may deteriorate quickly.
- The exterior of the Timer may be damaged by organic solvents (such as thinners or benzene), strong alkali, or strong acids.
- For Timers with AC power input, use a commercial power supply for the power supply voltage. Although some inverters give 50/60 Hz as the output frequency, do not use an inverter output as the power supply for a Timer. Doing so may result in smoking or burning due to internal temperature increases in the Timer.
- Use the same type of wiring for all Timer wiring.
- When disposing of the Timer, observe all local ordinances as they apply.
- The Timer may not operate properly in locations that are subject to sulfide gas, such as in sewers or incinerators. Products that are suitable for operation in sulfide gas are not available for OMRON Timers or general control devices. Seal the Timer to isolate it from sulfide gas. If the Timer cannot be sealed, OMRON can make special products with resistance to sulfide gas for some Timers. Ask your OMRON representative for details.
- Confirm that the power and output indicators are operating normally. Depending on the operating environment, the indicators and plastic parts may deteriorate faster than expected, causing the indicators to fail. Periodically perform inspections and replacements.

Precautions for Correct Use

● Changing Switch Settings

Do not change the time unit, time scale, operating mode, or INIT/TIME switch while the Timer is in operation. Doing so may result in malfunction. Turn OFF the power supply before changing the setting of any switch.

● Mounting and Dismounting

- Although there are no particular mounting restrictions, the Timer should be mounted as horizontally as possible.
- When mounting the Timer on a mounting Track, loosen the two hooks, press the Timer onto the Track, and then insert the hooks.

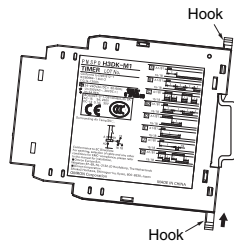

- When removing the Timer, pull out the two hooks, and then remove the Timer from the Track

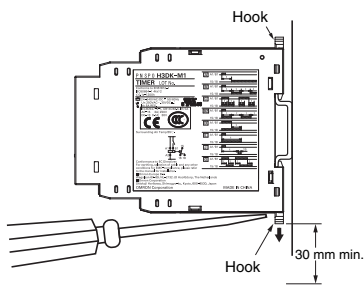

- It will be easier to mount and dismount the Timer if a distance of 30 mm or more is provided between the bottom of the Timer and other equipment.

● Power Supply

- The power supply can be connected to the power input terminals without considering polarity.
- A DC power supply can be connected if its ripple factor is 20% or less and the average voltage is within the allowable voltage fluctuation range of the Timer.
- For the power supply of the input device, use an isolating transformer in which the primary and secondary windings are mutually isolated and the secondary winding is not grounded. (H3DK-M1 and H3DK-M2 only)

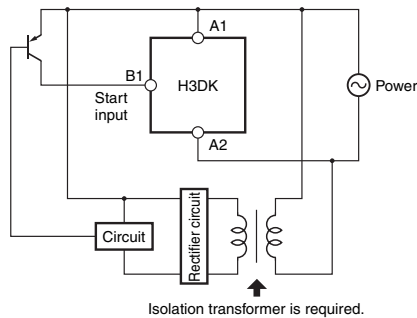

- The H3DK-H has a large inrush current. Provide sufficient power supply capacity. If the power supply capacity is too small, there may be delays in turning ON the output.

● Relationship between Input and Power Supply Circuits (H3DK-M1/M2)

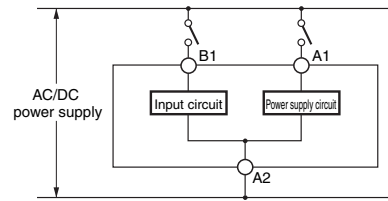

- The input circuit and the power supply circuit are configured independently. The input circuit can be turned ON and OFF without considering the ON/OFF state of the power supply. A voltage equivalent to the power supply voltage is also applied to the input circuit.
- If a relay or transistor is connected to two or more Timers, the input terminals of those Timers must be wired properly so that they will not be different in phase or the terminals will be short-circuited to one another. Always use the same power supply phases.

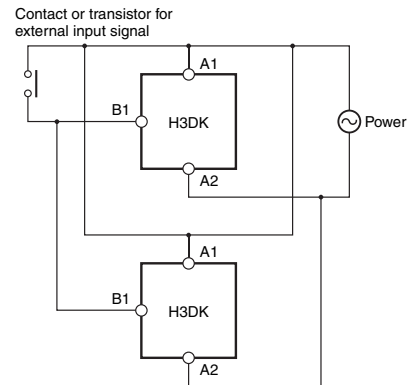
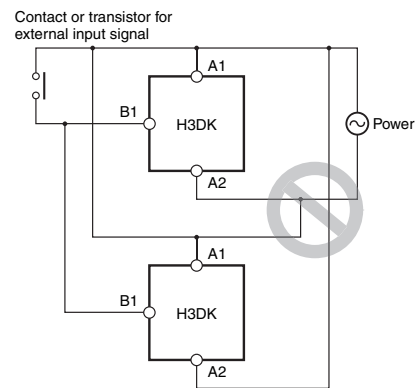

● Environment

- When using the Timer in an area with excessive electronic noise, separate the Timer and input device as far as possible from the noise sources. It is also recommended to shield the input signal wiring to prevent electronic interference.
- The external impulse voltage entering across the power supply terminals has been checked against a $\pm 1.2 \times 50 \mu\text{s}$ standard waveform according to JEC-210, Impulse Voltage/Current Test, of The Institute of Electrical Engineers of Japan. Surge or noise superimposed on the power supply may damage internal components or cause them to malfunction. We recommend that you check the circuit waveform and use surge absorbers. The effects on components depend on the type of surge and noise that are generated. Always perform testing with the actual equipment.

● Wiring

- Do not connect anything to unused terminals.
- The H3DK-H acts like a high-impedance circuit. Therefore, the Timer may not reset if it is influenced by inductive voltage. To eliminate inductive voltage, the wires connected to the Timer must be as short as possible and should not be installed parallel to power lines. If the Timer is influenced by inductive voltage that is 30% or more of the rated voltage, connect a CR filter with a capacitance of approximately 0.1 μ F and a resistance of approximately 120 Ω or a bleeder resistor between the power supply terminals.
If there is any residual voltage due to current leakage, connect a bleeder resistor between the power supply terminals.

● Operating Frequency

- The H3DK-H may malfunction if it is used as shown below. Do not use the H3DK-H in these ways.
Timer Repeatedly Times Out in Cycles of 3 s or Less

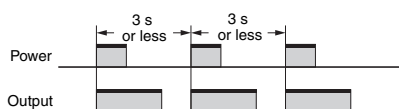

In the above case, use the H3DK-M2/-M1 in D mode (signal OFF delay).

● DC Power Consumptions (Reference Information)

H3DK-M2/-S2	At 24 VDC: 1.2 W max.
H3DK-M1/-S1	At 24 VDC: 1.1 W max.
H3DK-F	At 24 VDC: 1.1 W max.
H3DK-G	At 24 VDC: 1.2 W max.
H3DK-HBS/-HBL	At 24 VDC: 1.2 W max.

● Other Precautions

- If the Timer is mounted on a control panel, dismount the Timer from the control panel before carrying out a voltage withstand test between the electric circuits and non-current-carrying

metal parts of the Timer. (Otherwise, the internal circuits of the Timer may be damaged.)

- The H3DK-H uses a latching relay for the output. Shock, such as dropping the H3DK-H during shipment or handling, can cause the output contacts to reverse to the neutral position. Check the output status with a tester before using the H3DK-H.
- The life expectancy of the control output contacts is greatly affected by switching conditions. Always confirm operation using the actual conditions and equipment before using the Timer and make sure that the number of switching operations presents no problems in performance. If Timer application is continued after performance has deteriorated, insulation failure between circuits, burning of the control output relay, or other problem will eventually occur.
- If the power supply voltage is gradually increased, a power reset may occur or the Timer may time out. Use a switch, relay, or other device with contacts to apply the power supply voltage all at once.
- Make sure that residual voltage or inductive voltage is not applied after the power turns OFF.
- Error in the operation time of the Timer is given as a percentage of the full-scale time. The absolute value of the error will not change even if the set time is changed. Therefore, always use the Timer with the set time set as close as possible to the full-scale value of the set time range.
- When switching a microload, check the specified minimum load given for the Timer model you are using.
- When setting the operating time, do not turn the dial beyond the scale range.
- If better accuracy is required in the set time, adjust the dial while measuring the operation time.
- If the Timer is reset immediately after timing out, make sure that the circuit configuration allows sufficient resetting time. Errors will occur in the sequence if there is not sufficient resetting time.
- When directly switching a DC load, the switching capacity will be lower than when switching an AC load.



EN/IEC Standard Compliance

- Refer to the datasheet for the H3DK for cable selection and other conditions for compliance with EMC standards.
- The power supply terminals and input terminals are not isolated. There is basic insulation between the power supply terminals and output terminals.
- If double or reinforced insulation is required, use the double or reinforced insulation defined in IEC 60664 that is suitable for the maximum applied voltage for the clearance, solid insulation, and other factors.

Precautions for Compliance with UL Standards and CSA Standards

Notice to Users of the H3DK in the USA and Canada

Please use the following installation information instead of the general information in this document in order to use the product under certified conditions of UL and CSA when the product is installed in the USA or Canada. These conditions are required by NFPA 70, National Electrical Code in the USA and the Canadian Electrical Code, Part I in Canada and may vary from information given in this document.

- Use an isolated source for power input for the H3DK-□A.
Use an isolated source with external overcurrent protection of 16 A maximum for the source and input. (The input is applicable to the H3DK-M only.)
- Environment
Surrounding Air Temperature: 55°C
- Power Supply: The inputs are non-isolated (applicable to H3DK-M only).
The same power supply as the main power source must be used for that for input.
- Pollution Degree
Pollution degree II

H3DK

Track Mounting Products (Sold Separately)

(Unit: mm)

DIN Track PFP-100N PFP-50N

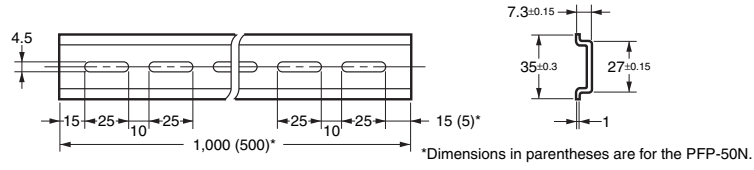
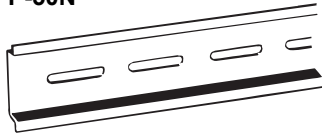

DIN Track PFP-100N2

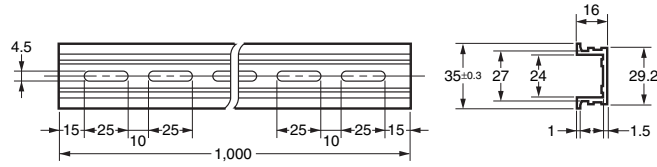
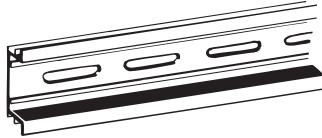

End Plate PFP-M

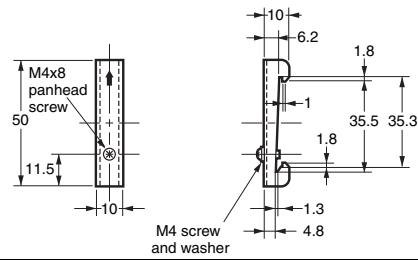

Spacer PFP-S

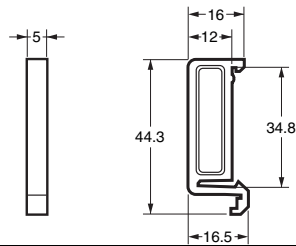
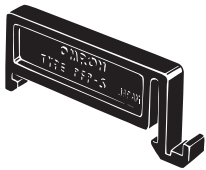

Note 1: Order the above products in multiples of 10.
Note 2: The Tracks conform to DIN standards.

Warranty and Application Considerations

Read and Understand This Catalog

Please read and understand this catalog before purchasing the products. Please consult your OMRON representative if you have any questions or comments.

Warranty and Limitations of Liability

WARRANTY

OMRON's exclusive warranty is that the products are free from defects in materials and workmanship for a period of one year (or other period if specified) from date of sale by OMRON.

OMRON MAKES NO WARRANTY OR REPRESENTATION, EXPRESS OR IMPLIED, REGARDING NON-INFRINGEMENT, MERCHANTABILITY, OR FITNESS FOR PARTICULAR PURPOSE OF THE PRODUCTS. ANY BUYER OR USER ACKNOWLEDGES THAT THE BUYER OR USER ALONE HAS DETERMINED THAT THE PRODUCTS WILL SUITABLY MEET THE REQUIREMENTS OF THEIR INTENDED USE. OMRON DISCLAIMS ALL OTHER WARRANTIES, EXPRESS OR IMPLIED.

LIMITATIONS OF LIABILITY

OMRON SHALL NOT BE RESPONSIBLE FOR SPECIAL, INDIRECT, OR CONSEQUENTIAL DAMAGES, LOSS OF PROFITS, OR COMMERCIAL LOSS IN ANY WAY CONNECTED WITH THE PRODUCTS, WHETHER SUCH CLAIM IS BASED ON CONTRACT, WARRANTY, NEGLIGENCE, OR STRICT LIABILITY.

In no event shall the responsibility of OMRON for any act exceed the individual price of the product on which liability is asserted.

IN NO EVENT SHALL OMRON BE RESPONSIBLE FOR WARRANTY, REPAIR, OR OTHER CLAIMS REGARDING THE PRODUCTS UNLESS OMRON'S ANALYSIS CONFIRMS THAT THE PRODUCTS WERE PROPERLY HANDLED, STORED, INSTALLED, AND MAINTAINED AND NOT SUBJECT TO CONTAMINATION, ABUSE, MISUSE, OR INAPPROPRIATE MODIFICATION OR REPAIR.

Application Considerations

SUITABILITY FOR USE

OMRON shall not be responsible for conformity with any standards, codes, or regulations that apply to the combination of products in the customer's application or use of the products.

Take all necessary steps to determine the suitability of the product for the systems, machines, and equipment with which it will be used.

Know and observe all prohibitions of use applicable to this product.

NEVER USE THE PRODUCTS FOR AN APPLICATION INVOLVING SERIOUS RISK TO LIFE OR PROPERTY WITHOUT ENSURING THAT THE SYSTEM AS A WHOLE HAS BEEN DESIGNED TO ADDRESS THE RISKS, AND THAT THE OMRON PRODUCTS ARE PROPERLY RATED AND INSTALLED FOR THE INTENDED USE WITHIN THE OVERALL EQUIPMENT OR SYSTEM.

Disclaimers

PERFORMANCE DATA

Performance data given in this catalog is provided as a guide for the user in determining suitability and does not constitute a warranty. It may represent the result of OMRON's test conditions, and the users must correlate it to actual application requirements. Actual performance is subject to the OMRON *Warranty and Limitations of Liability*.

CHANGE IN SPECIFICATIONS

Product specifications and accessories may be changed at any time based on improvements and other reasons. Consult with your OMRON representative at any time to confirm actual specifications of purchased product.

DIMENSIONS AND WEIGHTS

Dimensions and weights are nominal and are not to be used for manufacturing purposes, even when tolerances are shown.

ALL DIMENSIONS SHOWN ARE IN MILLIMETERS.

To convert millimeters into inches, multiply by 0.03937. To convert grams into ounces, multiply by 0.03527.

Note: Do not use this document to operate the Unit.

OMRON Corporation Industrial Automation Company

Kyoto, JAPAN

Contact : www.ia.omron.com

Regional Headquarters

OMRON EUROPE B.V.

Wegalaan 67-69, 2132 JD Hoofddorp
The Netherlands

Tel: (31) 2356-81-300 Fax: (31) 2356-81-388

OMRON ASIA PACIFIC PTE. LTD.

438B Alexandra Road, #08-01/02 Alexandra
Technopark, Singapore 119968

Tel: (65) 6835-3011 Fax: (65) 6835-3011

OMRON ELECTRONICS LLC

2895 Greenspoint Parkway, Suite 200
Hoffman Estates, IL 60169 U.S.A.

Tel: (1) 847-843-7900 Fax: (1) 847-843-7787

OMRON (CHINA) CO., LTD.

Room 2211, Bank of China Tower,
200 Yin Cheng Zhong Road,
PuDong New Area, Shanghai, 200120, China

Tel: (86) 21-6023-0333 Fax: (86) 21-5037-2388

Authorized Distributor:

©OMRON Corporation 2010-2024 All Rights Reserved.
In the interest of product improvement,
specifications are subject to change without notice.

CSM_7_7

Cat. No. L118-E1-05 0524 (0910)