

DEECOS S mini

742196.004 | Surface mounted projector



Surface mounted projectors
4051859818526
D 87, H 214

Track on ceiling, Wall track
silver

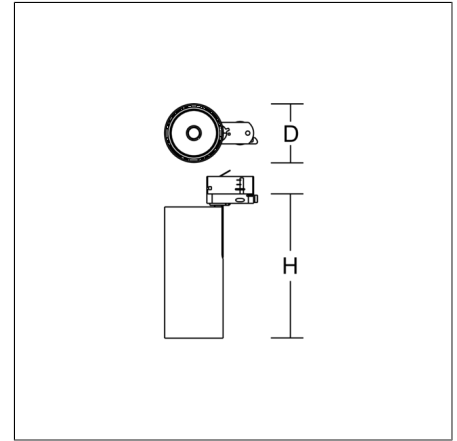









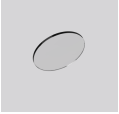

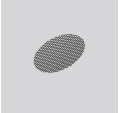





LED surface-mounted projector in modern design with no visible cooling ribs. Housing: die-cast aluminium, powder-coated. Rotation range: 356°. Swivel range: 90°. Black plastic ring and recessed LED to prevent glare from the side. Optical assembly with reflector made of MIRO-Silver with 98% total light reflection for outstanding efficiency - can be changed without tools. Best colour rendering index Ra>90. With multi adaptor for 3-circuit tracks 230 V. Suitable for Track on ceiling, Wall track. High quality converter without flickering and stroboscopic effect. The following accessories can be mounted without use of tools: interchangeable lenses, decorative glasses, honeycomb louvre, clear and frosted diffusers, white interchangeable plastic ring.

Product specifications

Diameter D	87 mm
Height H	214 mm
Weight	1.15 kg
Light source	LED
Colour temperature	3000 K
Rated luminous flux	2450 lm
System power	20 W
System efficiency	123 lm/W
Glare evaluation UGR (4H 8H)	14,3
Beam angle	31°
Rated life	50000 h (L90/B10)
Colour rendering index (CRI)	92
Colour tolerance	2
Photobiological safety according to EN 62471	Risk group 1
Driver	Converter
Control	on/off
Voltage	220 - 240 V / 50 Hz, 60 Hz
Luminaires on B10A fuse	21
Luminaires on B16A fuse	34
Luminaires on C10A fuse	35
Luminaires on C16A fuse	57
Inrush current / Inrush current duration	9.92 A / 230 µs
CIE Flux Code / CEN Flux Code	99 100 100 100 100
Type of protection	IP 20
Protection class	I
Filament test	650 °C
Impact resistance	IK06
Ambient temperature	-20 °C ... + 25 °C
Conformity mark	CE, EAC

Accessories

	982370.000 Diffuser, transparent		982370.010 Diffuser, satinated
	982371.003 Anti-glare honeycomb louvre		982369.003 Spot lens
	982369.013 Medium lens		982369.023 Flood lens
	982421.002 White plastic ring for lens.		982368.003 Reflector spot
	982368.013 Reflector medium		982368.023 Reflector flood
	982369.033 Wide flood lens		982369.043 Oval corridor lens
	982419.002 White plastic ring for reflector.		982368.033 Reflector wide flood
	982647.002 Decorative glass opal matt		982648.002 Decorative glass opal matt
	70319.009 Point outlet for 3-circuit multi adaptor		