

PRODUCT DATASHEET

FL PFM 125 W 3000 K SYM 100 BK

FLOODLIGHT 125 W | Versatile floodlight with up to 15000 lm light output



Areas of application

- Replacement for floodlights with halogen lamps
- Outdoor use (IP65)
- Industry
- Public areas
- Construction areas
- Building facades

Product benefits

- Bright, robust and durable
- Safe and very uniform illumination, due to frosted and tempered glass diffuser
- No upper light output ratio (ULOR 0%) when mounted at 0° tilt
- Energy savings of up to 90 % compared to halogen lamp floodlights
- 5 years guarantee

Product features

- Reflector-based, symmetric light distribution with 100° x 100° beam angle
- Integrated wide voltage driver, suitable for 100 - 277 V_{AC}
- Surge protection: up to 6 kV (L/N-PE), 4 kV (L-N)
- Mounting bracket with 30° angle and wide rotation area
- Breather membrane to optimize air exchange, without compromising IP protection
- Pre-installed, flexible 1 m cable (H05RN-F), wrapped 3 x 1.0 mm² single wires



TECHNICAL DATA

Electrical data

| | |
|---|-----------------------|
| Nominal wattage | 125.00 W |
| Nominal voltage | 100...277 V |
| Mains frequency | 50...60 Hz |
| Nominal current | 630 mA |
| Inrush current | 60 A |
| Inrush current time T_{h50} | 1000 μ s |
| Max. number of luminaires per miniature circuit breaker B16 | 4 |
| Max. number of luminaires per miniature circuit breaker C10 | 7 |
| Max. number of luminaires per miniature circuit breaker C16 | 11 |
| Power factor λ | > 0.90 |
| Total harmonic distortion | < 20 % |
| Protection class | I |
| Operating mode | Integrated LED driver |

Photometrical data

| | |
|--|---------------------------|
| Luminous flux | 13750 lm |
| Luminous efficacy | 110 lm/W |
| Color temperature | 3000 K |
| Light color (designation) | Warm White |
| Color rendering index Ra | \geq 80 |
| Standard deviation of color matching | \leq 5 sdc _m |
| Luminous intensity | - |
| Low flicker | Yes |
| Flickering metric (Pst LM) | - |
| Stroboscope effect metric (SVM) | - |
| Photobiological safety group acc. to EN62778 | RG1 |
| Photobiological safety group acc. to EN62471 | RG1 |
| Beam angle | 100 ° x 100 ° |



FL PFM 125W3000K SYM 100 BK

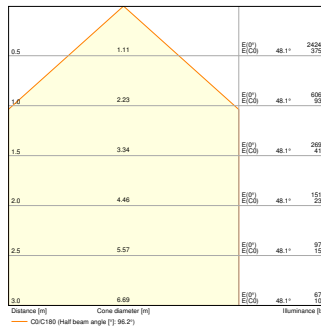

FL PFM 125W 3000K SYM 100 BK

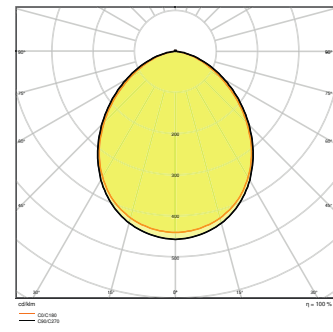

FL PFM 125W3000K SYM 100 BK

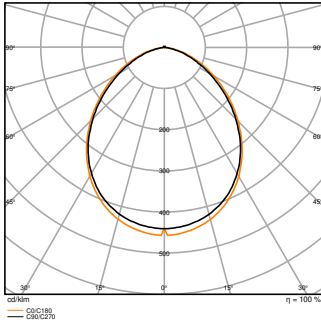

FL PFM 125W 3000K SYM 100 BK

Dimensions & Weight

| | |
|----------------|-----------|
| Length | 381.00 mm |
| Width | 290.00 mm |
| Height | 59.00 mm |
| Product weight | 3800.00 g |
| Cable length | 1000 mm |

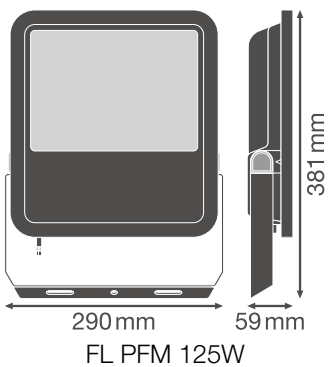

Materials & Colors

| | |
|--|----------|
| Product color | Black |
| Housing color | Black |
| Body material | Aluminum |
| Light emitting surface material | Glass |
| Glow Wire Test according to IEC 60695-2-12 | 650 °C |
| Mercury content | 0.0 mg |

Application & Mounting

| | |
|--|-------------------------------|
| Ambient temperature range | -30...+50 °C |
| Temperature range at storage | -40...+70 °C |
| Type of connection | Cable, 3-pole |
| Type of protection | IP65 |
| Protection class IK (shock resistance) | IK08 |
| Dimmable | No |
| Mounting type | Surface |
| Mounting location | Wall / Pole / Floor / Ceiling |
| Application environment | Outdoor |
| Adjustable | Yes |
| With light source | Yes |

Lifespan

| | |
|----------------------------|-----------------------|
| Lifespan L70/B50 at 25 °C | 70000 h ¹⁾ |
| Lifespan L80/B10 at 25 °C | 55000 h ¹⁾ |
| Lifespan L80/B50 at 25 °C | 55000 h |
| Lifespan L90/B10 at 25 °C | 35000 h |
| Number of switching cycles | 100000 |

¹⁾ t[h]: L70 / B50 @ 25 °C (Ta), t[h]: L80 / B10 @ 25 °C (Ta), t[h]: L90 / B10 @ 25 °C (Ta)

Control gear

| | |
|-----------------------------|--------|
| Output current | 740 mA |
| ECG - Output ripple current | < 35 % |

Certificates & Standards













| | |
|--|-----------------------------------|
| Standards | CE / CB / ENEC / EAC / RoHS / EPD |
| Luminaire with limited surface temperature, "D sign" | No |







| | |
|----------------------------------|----------------------|
| Ball shot safe | No |
| EPD | LEDV-00017-V01.01-EN |
| Replaceable light source (EPREL) | Not replaceable |



Safety advice

– Max. wind load surface 0.083 m²

DOWNLOAD DATA

| Documents and certificates | | Document name |
|--|--|------------------------------------|
|  | User instruction / safety instructions | UI FL PFM 65W - 200 W |
|  | Legal information | LSI FL PFM SYM |
|  | Legal information | LSI FL PFM SYM |
|  | Legal information | Legal Insert FL PFM |
|  | Legal information | Informationstext 18 Abs 4 ElektroG |
|  | Declarations of conformity | FLOODLIGHT PFM |
|  | Declarations of conformity UKCA | FL PFM SYM |
| Photometric and lighting design files | | Document name |
|  | IES file (IES) | FL PFM 125W3000K SYM 100 BK |
|  | IES file (IES) | FL PFM 125W 3000K SYM 100 BK |
|  | LDT file (Eulumdat) | FL PFM 125W3000K SYM 100 BK |
|  | LDT file (Eulumdat) | FL PFM 125W 3000K SYM 100 BK |
|  | ULD file (DIALux) | FL PFM 125W-3000K SYM 100 BK |

| Photometric and lighting design files | | Document name |
|---|-------------------------------------|------------------------------|
|  | ROLF file (RELUX) | FL PFM 125W-3000K SYM |
|  | UGR file (UGR table) | FL PFM 125W3000K SYM 100 BK |
|  | UGR file (UGR table) | FL PFM 125W 3000K SYM 100 BK |
|  | Light distribution curve type cone | FL PFM 125W3000K SYM 100 BK |
|  | Light distribution curve type cone | FL PFM 125W 3000K SYM 100 BK |
|  | Light distribution curve type polar | FL PFM 125W3000K SYM 100 BK |
|  | Light distribution curve type polar | FL PFM 125W 3000K SYM 100 BK |

| CAD/BIM files | | Document name |
|---|--------------|---------------|
|  | BIM Revit 3D | Floodlight G3 |
|  | CAD STEP 3D | FL G3 125W |

| Tender texts | | Document name |
|---|------------------|---------------------------------------|
|  | Tender documents | FLOODLIGHT 125 W 3000 K SYM 100 BK-EN |

LOGISTICAL DATA

| Product code | Packaging unit (Pieces/Unit) | Dimensions (length x width x height) | Gross weight | Volume |
|---------------|------------------------------|--------------------------------------|--------------|-----------------------|
| 4058075423695 | Shipping box 1 | 343 mm x 92 mm x 443 mm | 4305.00 g | 13.98 dm ³ |

The mentioned product code describes the smallest quantity unit which can be ordered. One shipping unit can contain one or more single products. When placing an order, for the quantity please enter single or multiples of a shipping unit.

ADDITIONAL CATALOG INFORMATION

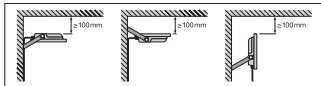
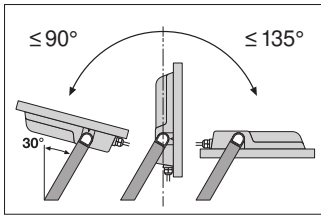

| | A | B | C | | |
|------|-----|-----|------|--------|---------------------|
| 65W | 150 | 108 | 8.5 | 2x MB | 0,046m ² |
| 80W | 150 | 108 | 10.5 | 2x M10 | 0,061m ² |
| 125W | 170 | 118 | 10.5 | 2x M10 | 0,083m ² |
| 165W | 170 | 118 | 12.5 | 2x M12 | 0,102m ² |
| 200W | 170 | 118 | 12.5 | 2x M12 | 0,124m ² |

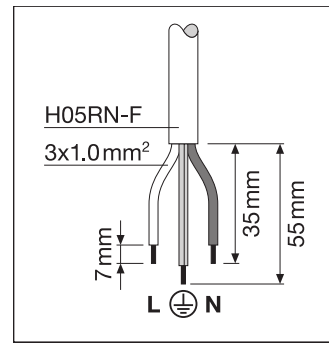

References / Links

– For Guarantee see www.ledvance.com/guarantee

DISCLAIMER

Subject to change without notice. Errors and omission excepted. Always make sure to use the most recent release.