

INSTRUCTION

Cadero Disca
582110.0031.25

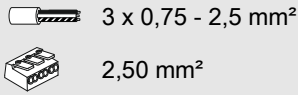

~ 220 - 240 V 50/60 Hz IP 66, IP 66 IK08



Umgebungstemperatur /
temperature ambiante
=> -20 °C ... + 45 °C

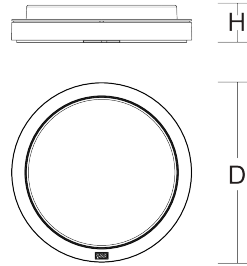

D 311, H 64



2,94 kg



Φ_{lm} [lm]

P_{in} [W]

P_{out}

LED

300

4,5

1 x 4 W

CCT [K]

CRI

RG RG_{1}

EEK D

3000

80

RG 1

D

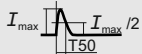

5 A / 150 μ s

$\text{COS } \varphi$

0,93

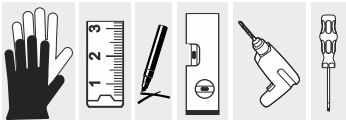



Allgemeine Sicherheitshinweise

- Der elektrische Anschluss muss ordnungsgemäß nach geltenden Normen und den nationalen sowie internationalen Sicherheits- und Unfallverhütungsvorschriften erfolgen.
- Beschädigte Leuchten dürfen nicht betrieben werden.
- Keine Haftung für Schäden durch unsachgemäßen Einsatz.
- Bei Instandsetzung nur Originalteile verwenden.
- Tragfähigkeit der Decke und Befestigungselemente sicherstellen.

Betrieb der Leuchte

- Die unzulässigen Umgebungstemperaturen reduzieren die Lebensdauer der Leuchte, im Extremfall droht der Frühausfall.
- Zur Vermeidung von EMV-Problemen die Durchgangsverdrahtung nicht entlang der Leuchtenverdrahtung führen.
- Steuereingänge von dimmbaren Leuchten mit handelsüblichen für Netzspannung geeigneten Leitungen anschließen.

Manipulationen unserer Produkte sind unzulässig

Veränderung, Umarbeitung, Umkennzeichnung von Produkten sowie deren Verpackung sind unzulässig und verletzen u.a. unsere eingetragenen Warenzeichenrechte. Solche Modifikationen können technische Eigenschaften unserer Produkte negativ beeinflussen, diese zerstören und möglicherweise Folgeschäden an anderen Objekten verursachen. Für durch derartige Modifikationen verursachte Schäden kann der Hersteller in keinem Fall verantwortlich gemacht werden.



General Safety Information

- Electric connection must be appropriate according to all applicable standards and other national and international safety and accident prevention regulations.
- Damaged luminaires must not be operated.
- No liability is accepted for damages resulting from improper use.
- Use genuine parts only for repair.
- Ensure stability of the ceiling and fastening elements.

Operation of the luminaire

- Exceeding the permissible ambient temperature will reduce the luminaire's lifecycle, resulting in premature failure in extreme cases.
- Avoid ESD problems by not routing feed-through wiring directly along the wiring of the luminaire.
- Connect control inputs of dimmable luminaires with standard cables suitable for power supply voltage.

Manipulation of our products is not permitted

Modifications, reworking, re-labelling of products as well as their package is not permitted and infringes, amongst others, our registered trademark rights. Such modifications may affect technical properties of our products, damage them and possibly cause consequential damage to other objects. The manufacturer shall not be responsible under any circumstances for damage caused by such modifications.





Bei Fragen zu unseren Symbolen, besuchen Sie folgende Webseite:
 If you have any questions about our signs, visit the following website:



https://www.rzb.de/fileadmin/assets/downloads/PDF/RZB_Symbolklaerung.pdf



Dieses Produkt enthält eine Lichtquelle der Energieeffizienzklasse D entsprechend Verordnung (EU) 2019/2015

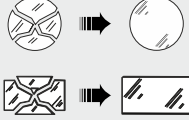

This product contains a light source of energy efficiency class D according to regulation (EU) No 2019/2015



Jede zersprungene Schutzabdeckung ist zu ersetzen. DIN EN 60598

Replace any cracked protective shield. IEC DIN EN 60598

Hinweis zum Einsatz von Leuchten mit D - Kennzeichnung nach EN 60598-2-24
 Reference for application of lumiaires with D - marking according to EN 60598-2-24

 <p>IP 4x</p>	<p><u>Umgebung ohne Staubablagerung</u> Environment without dust deposit</p>
 <p>IP 5x</p>	<p><u>Umgebung mit nicht elektrisch leitender Staubablagerung</u> Environment with non-electrically conductive dust deposit</p>
 <p>IP 6x₋₊</p>	<p><u>Umgebung mit elektrisch leitender Staubablagerung</u> Environment with electrically conductive dust deposit</p>



IP 66



IP 66



HYTRONIK®

HYTRONIK INDUSTRIAL LIMITED
Room D, 10/F, Tower A, Billion Center, 1 Wang Kwong Road,
Kowloon Bay, Kowloon, Hongkong
T: 00852-31197525 F: 00852-30114936
E: info@hytronik.com

CHINA FACTORY
Pude Industrial Park, Dushi Village, Pingtan Town
Huayang District Huizhou City Guangdong, P.R.C. 516259
T: 86-752-2772620 F: 86-752-2777877
E: info@hytronik.com W: www.hytronik.com

Declaration of Conformity

We, Hytronik Electronics Co., Ltd

No.1 plant ,Tangbeiyuan village group, Dushi Village, Pingtan Town, Huiyang District, Huizhou , Guangdong ,China. Declare at our sole responsibility, that the devices as following are designed and manufactured is in conformity with the Provisions of the following EU Directive(s) and that the standards and /or technical specifications referenced.

Brand:	Hytronik
Product models:	DS05
Type:	Motion sensor
Relevant EU directives:	2014/53/EU; 2011/65/EU(With amendment EU 2015/863);
Standards complied	EN 60669-1:2018 EN 60669-2-1:2004/A12:2010 EN 55015:2019/A11:2020 EN 61547:2009 EN IEC61000-3-2:2019/A11:2021 EN 61000-3-3:2013/A2:2021 EN 300 440 V 2.2.1 EN 301489-1 V2.2.3 EN 301489-3 V2.2.0 EN 50663:2017

We declare as the manufacturer that the mentioned above complies with all essential requirements in the way specified and conforms with the type for which is above mentioned, and be affixed the CE-mark on the product or to the packaging and any accompanying documentation.

Sep.30th,2022

(place and date of issue)



Simon Xia

(Test Dep. Manager)(Simon Xia)

DIP-Schalter-Einstellungen / DIP Switch Settings

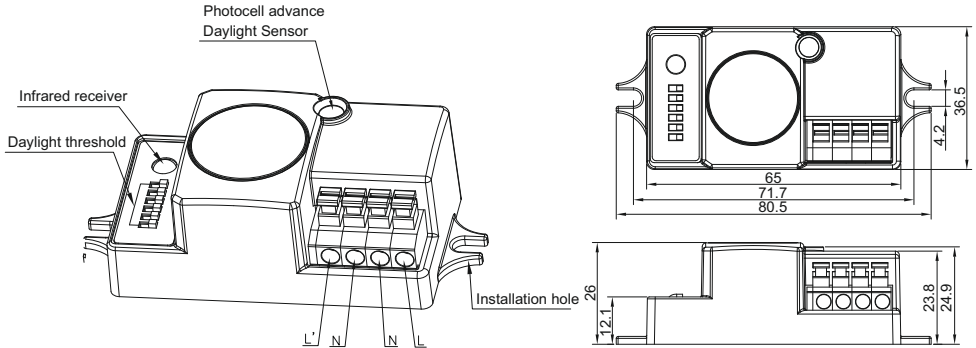

DIP-Schalter-Einstellung (Tageslichtschwellenwert)

Stellen Sie den Lux-Wert entsprechend der tatsächlichen Anwendungsumgebung ein. Licht bleibt ausgeschaltet, wenn das Tageslicht ausreicht (über dem eingestellten Schwellenwert). Bei unzureichendem Tageslicht schaltet sich das Licht automatisch ein. Das Licht schaltet sich nie aus, wenn der Tageslichtschwellenwert auf "Deaktivieren" eingestellt ist.

DIP switch setting (Daylight Threshold)

Set the lux level according to the real application environment. Light keeps off if ambient daylight is sufficient (above the threshold preset). With insufficient natural light, light will automatically turn on. Light will never switch off when daylight threshold is set to disable.

	1	2	3	4	5	6			1	2	3	4	5	6	
I	●	●	●	●	●	●	Disable	V	○	○	○	●	○	○	50 Lux
II	●	○	○	○	○	○	2 Lux	VI	○	○	○	○	●	○	100 Lux
III	○	●	○	○	○	○	10 Lux	VII	○	○	○	○	○	●	300 Lux
IV	○	○	●	○	○	○	30 Lux	VIII	○	○	○	○	○	○	500 Lux



Informationen / Informations

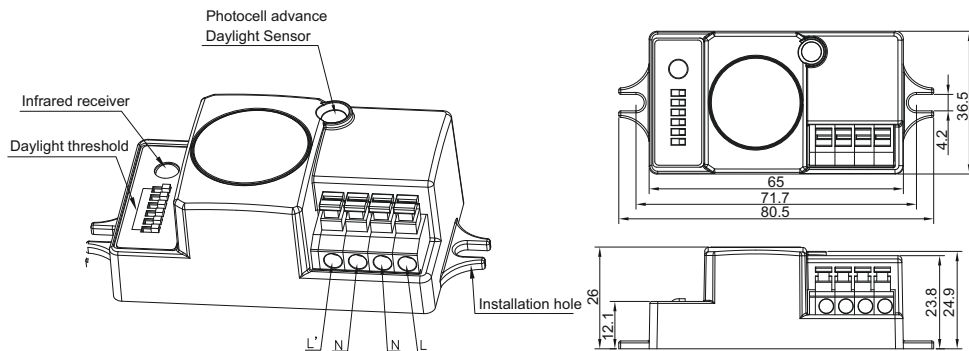

- Der Sensor reagiert lediglich auf natürliches Licht... nicht auf künstliches Licht!
 - Der Sensor macht alle 5 Min. eine Lichtmessung... und überprüft die Helligkeit...
 - Die Abschaltung beträgt ca. 5 Min.
 - Zur Prüfung kann der Sensor komplett abgedeckt werden...
- Nach dem Einschalten der LED (nach ca. 10 sek.) muß der Sensor jedoch noch weitere ca. 10 sek. abgedeckt bleiben, um eine Abschaltung von ca. 5 Min. sicherzustellen !!!

-
- The sensor only reacts to natural light...not to artificial light!
 - The sensor takes a light measurement every 5 minutes...
 - The switch-off time is approx. 5 minutes.
 - The sensor can be completely covered for testing.
- After switching on the LED (after approx. 10 sec.), however, the sensor must remain covered for a further approx. 10 sec. to ensure a switch-off of approx. 5 min... !!!

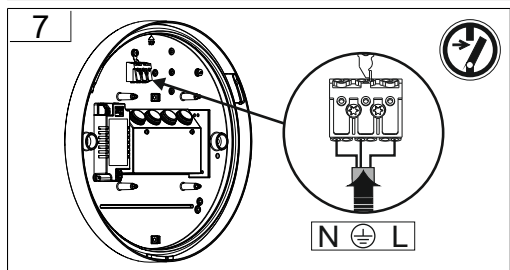
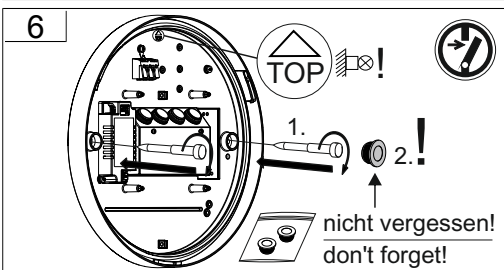
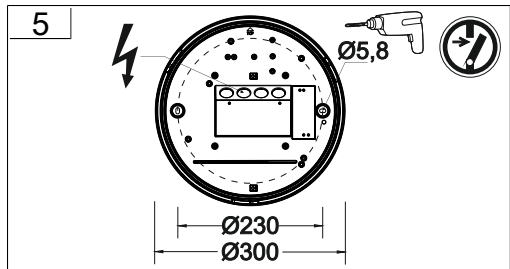
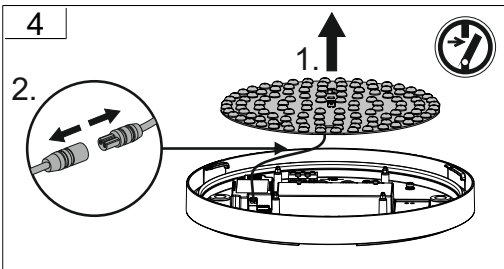
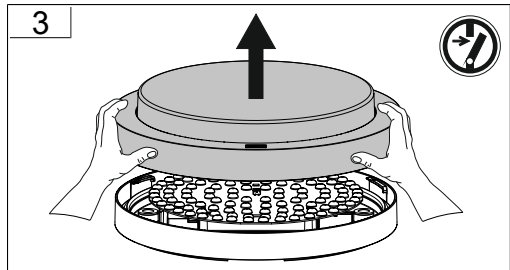
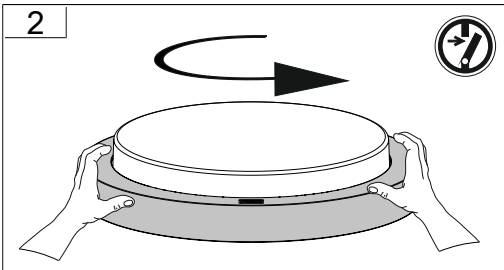
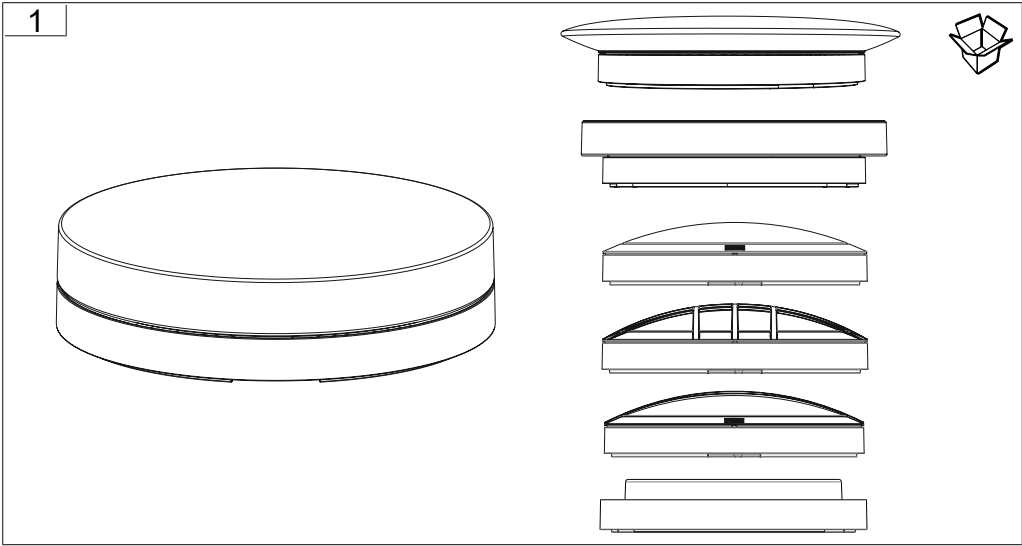
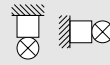

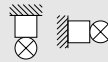

8

Konvertereinstellung / Converter setting

Iout	Pout	1	2	
90 mA	3,8W	-	-	3000K → 300-330lm
140 mA	5,9W	-	ON	4000K → 310-340lm
190 mA	8W	ON	-	3000K → 780-850lm
240 mA	10,1W	ON	ON	4000K → 800-880lm

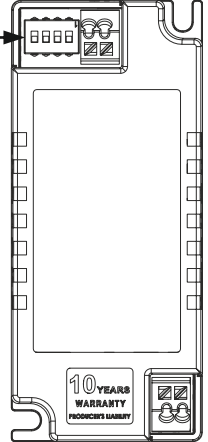

9

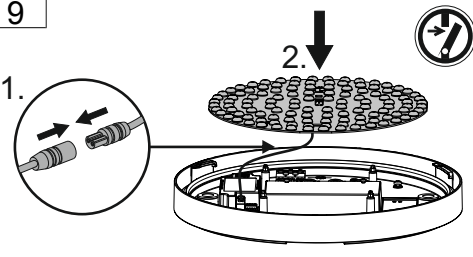

10

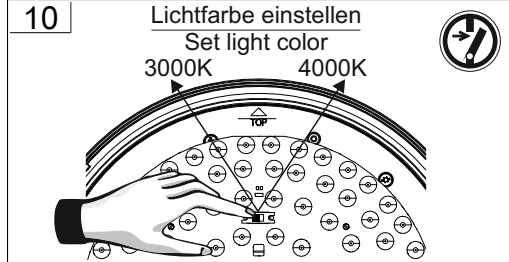

11

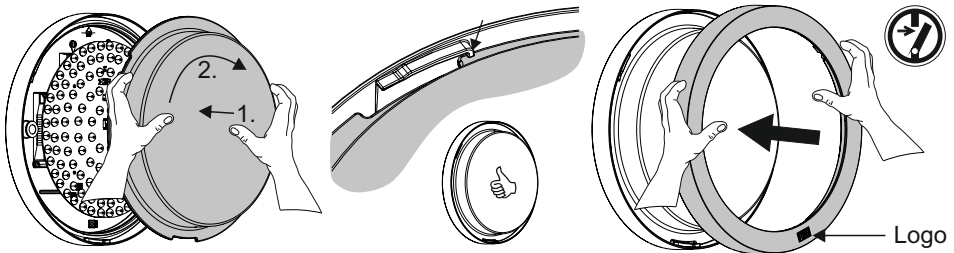

12

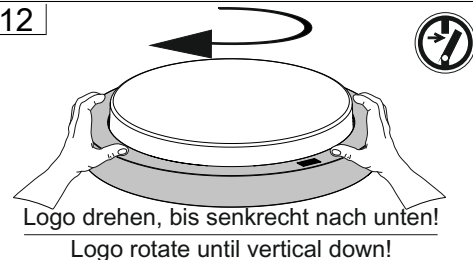

13

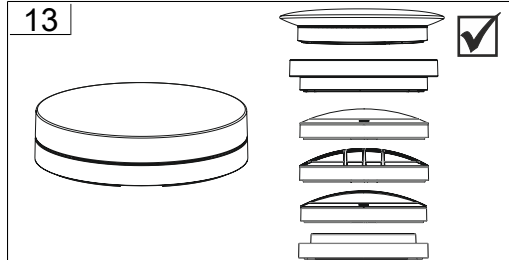

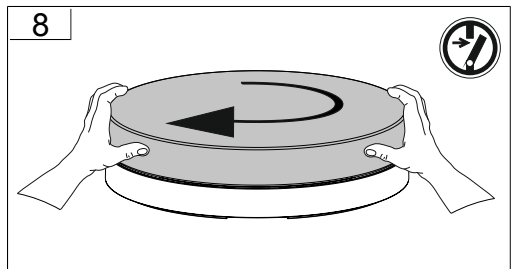
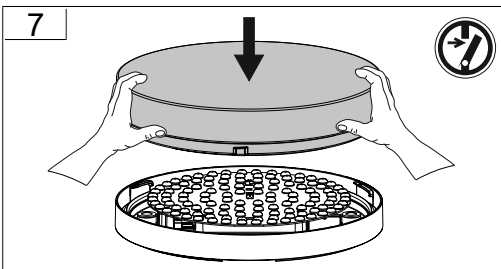
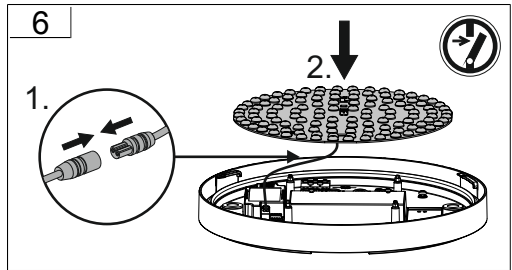
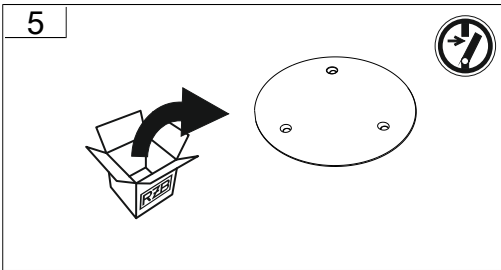
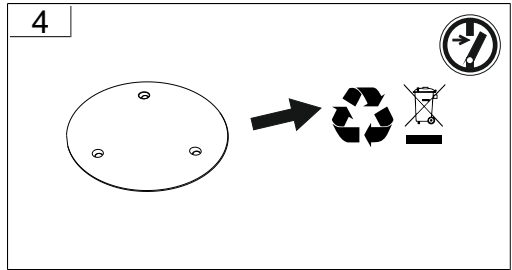
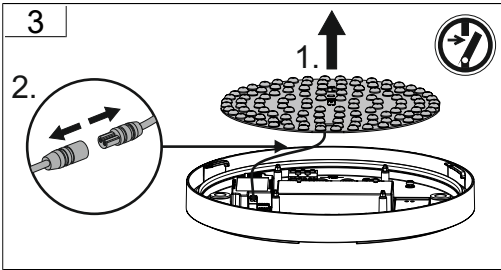
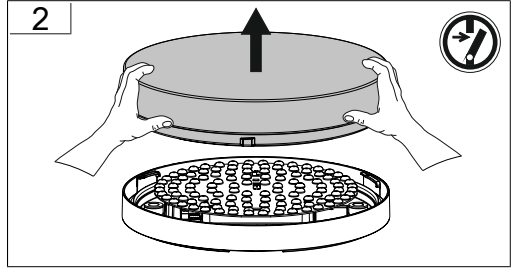
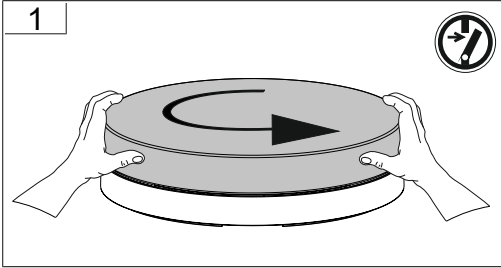

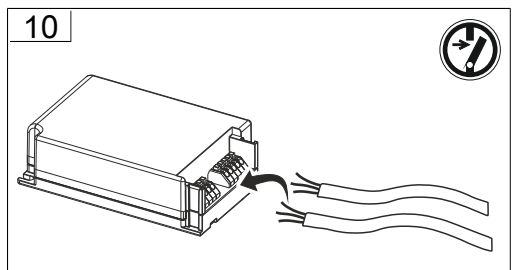
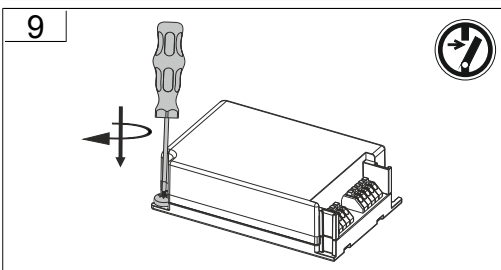
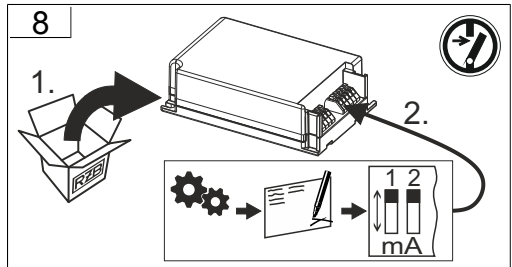
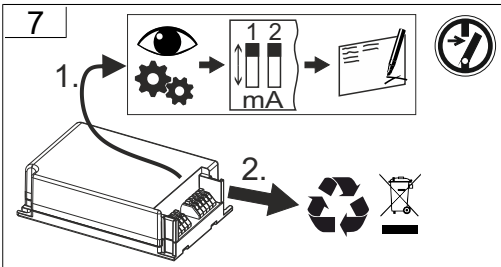
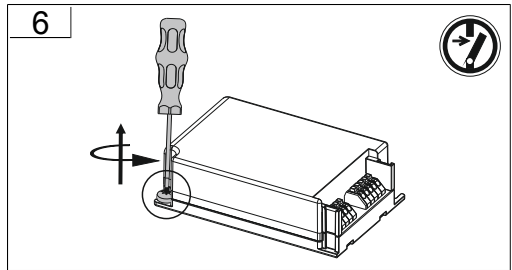
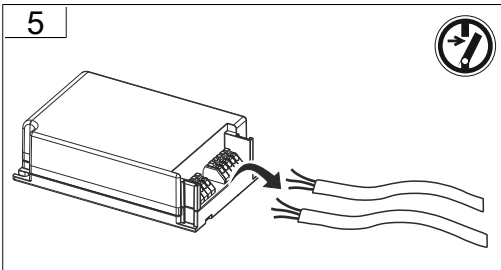
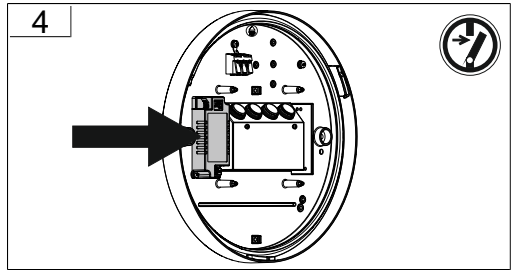
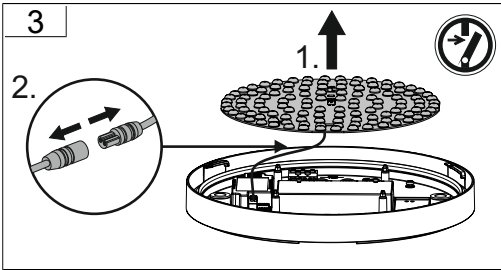
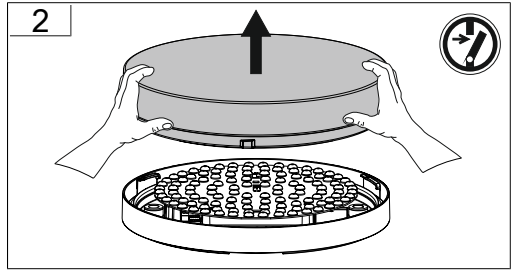
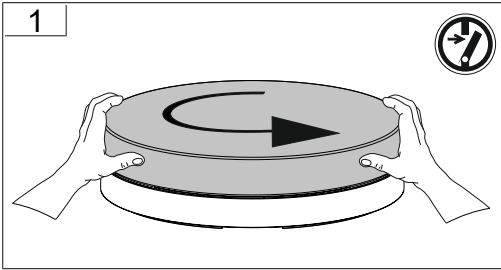

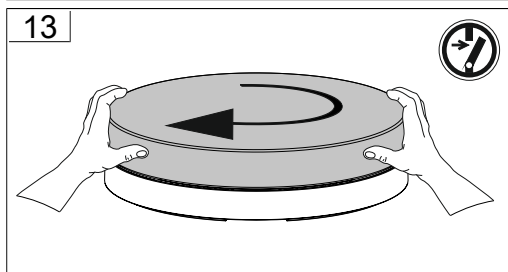
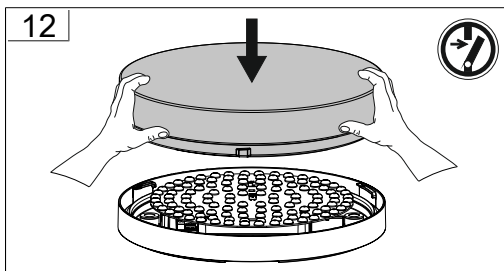
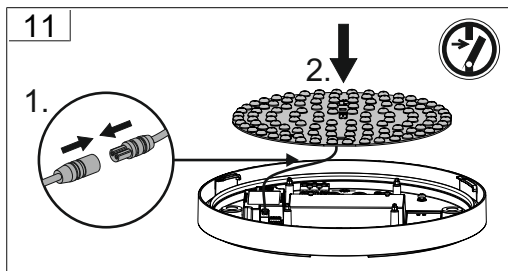

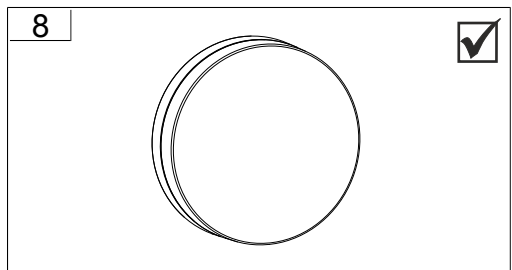
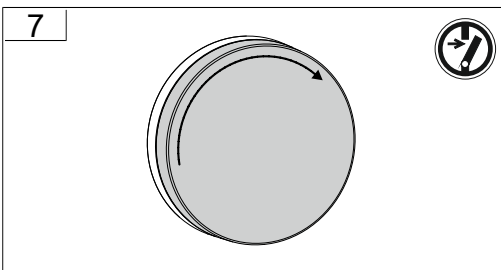
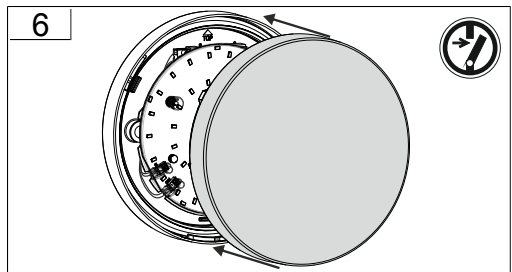
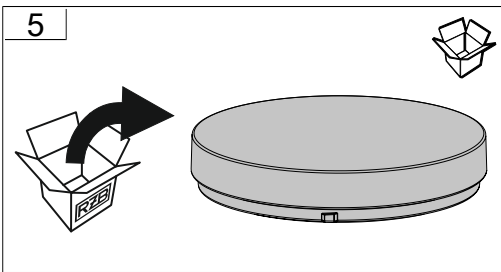
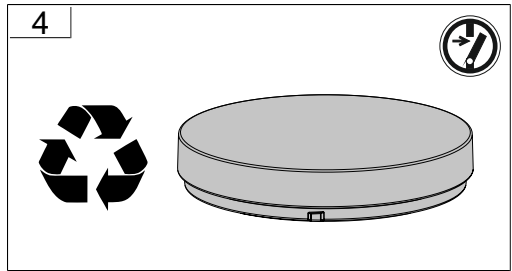
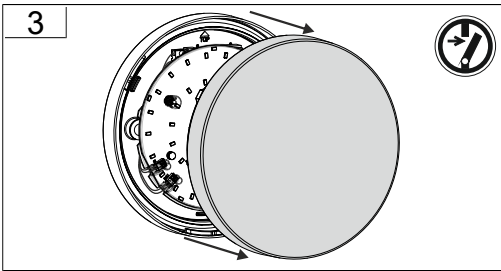
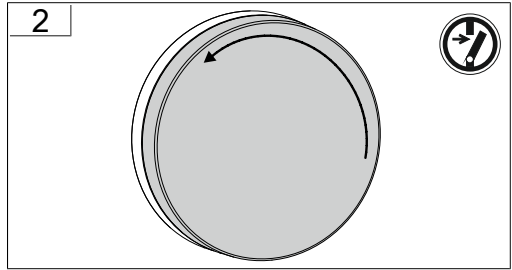
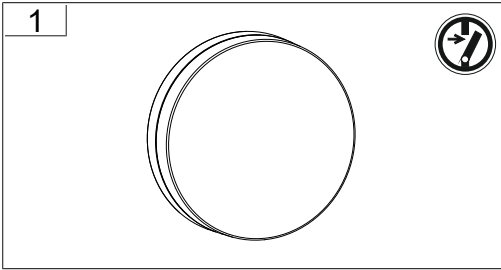

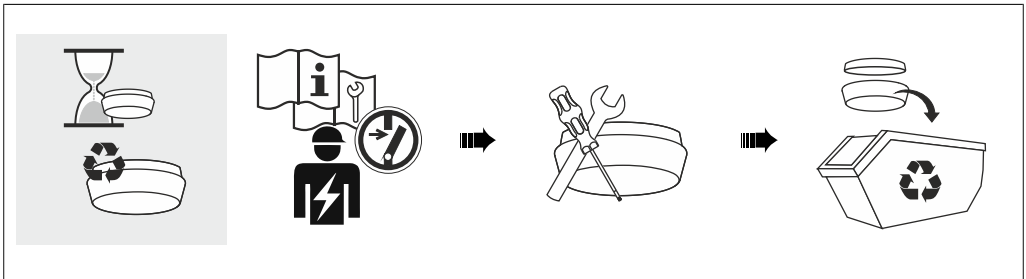
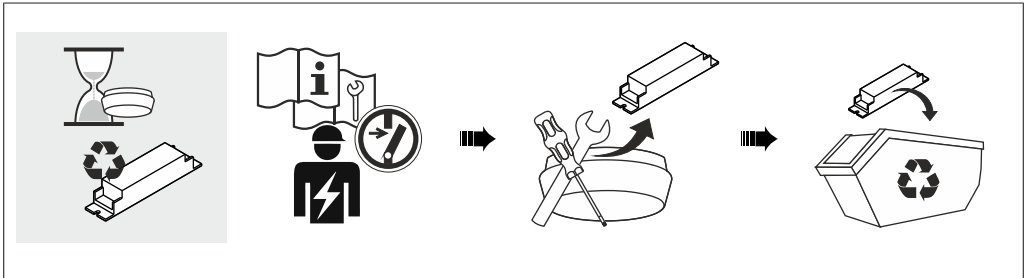
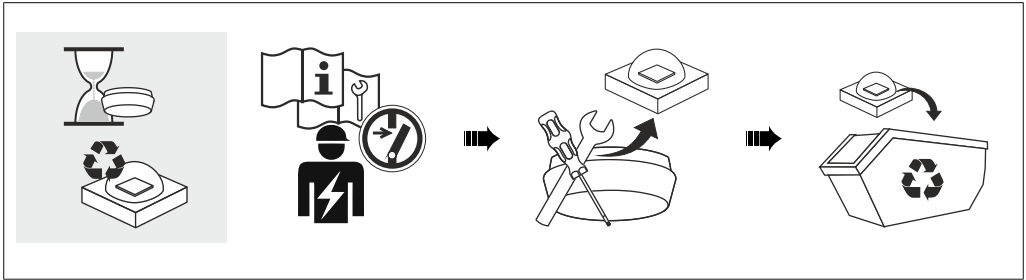



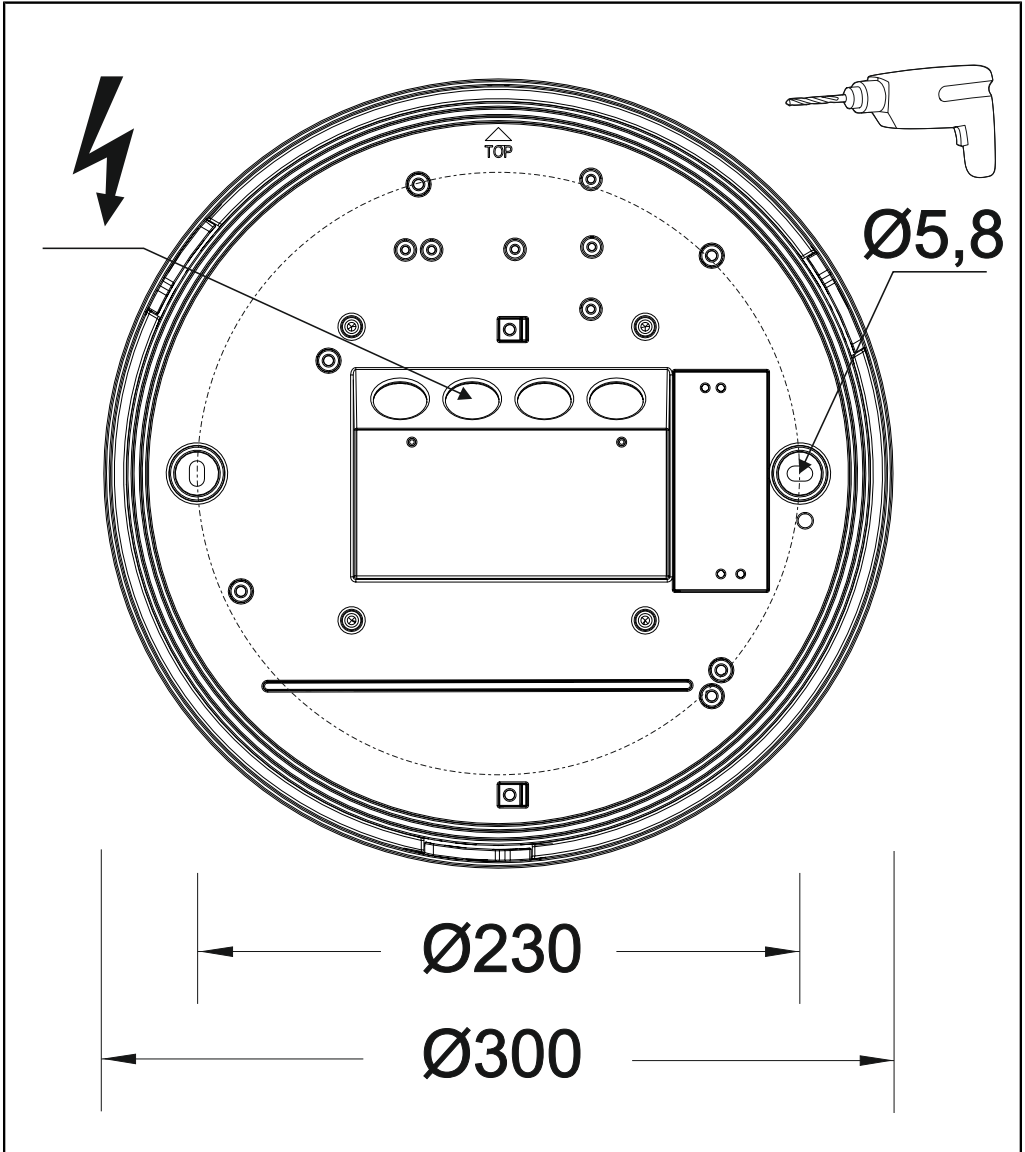

RZB - Rudolf Zimmermann, Bamberg GmbH

Rheinstraße 16, 96052 Bamberg

0951/7909-0

0951/7909-198

info@rzb-leuchten.de