

PRODUCT DATASHEET

PL PROT 625 P 36W 840 DALIVR

PANEL PROTECT 625 DALI | Square recessed panel luminaires with IP54 protection, DALI-2 IoT technology, 625 x 625 mm

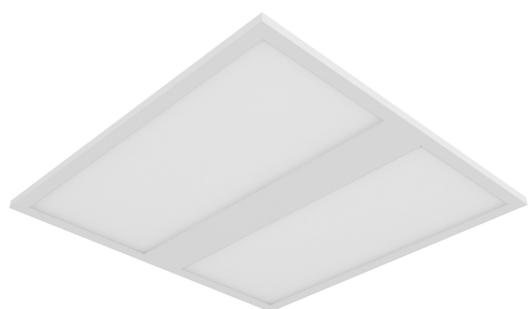

Areas of application

- Direct replacement for luminaires with fluorescent lamps
- Suitable for recessed ceiling systems with grid size of 625 x 625 mm
- Hospitals
- Laboratories
- Kitchens, canteens, workspaces

Product benefits

- Suitable for use in applications where a higher IP protection is needed
- High lumen output with up to 5040 lm
- Tool-free electrical connection due to push button connector
- Through-wiring possible with included connector box
- Energy savings thanks to high system efficacy: up to 140 lm/W
- High color consistency with SDCM 3
- Extended services such as energy monitoring and remote maintenance possible with DALI versions
- External driver for extended flexibility and easy installation
- Easy cleanable frontside thanks to the smooth PMMA surface of the diffuser
- Suitable for battery emergency installations acc. to EN 60598-2-22
- Decentral emergency lighting possible with separately available LEDVANCE Emergency Conversion Box
- 5 years guarantee

Product features



- Type of protection: IP54 (frontside), IP20 (backside)
- Steel housing with notch in the backside for the driver to allow maximum height of 34 mm
- PMMA diffuser
- 5-pole terminal block, cable cross section up to 5 x 2.5 mm²
- Lifetime (L90/B10): 50,000 h (at 25° C)
- Panel can be customized with optical sensors on individual request

TECHNICAL DATA

Electrical data

Nominal wattage	36.00 W ¹⁾
Nominal voltage	220...240 V
Mains frequency	0/50/60 Hz
Nominal current	165.000 mA
Inrush current	0.2 A
Inrush current time T _{h50}	450 µs
Max. number of luminaires per miniature circuit breaker B16	23
Max. number of luminaires per miniature circuit breaker C10	16
Max. number of luminaires per miniature circuit breaker C16	26
Power factor λ	> 0.90
Total harmonic distortion	< 20 %
Protection class	II
Operating mode	External LED driver
Dimming interface	DALI-2 / IoT

¹⁾ The Panel Protect family is fulfilling the technical minimum requirements according to the German BEG subsidy program for energy efficient luminaires

Photometrical data

Luminous flux	5040 lm ¹⁾
Luminous efficacy	140 lm/W ¹⁾
Color temperature	4000 K
Light color (designation)	Cool White
Color rendering index Ra	> 80
Standard deviation of color matching	3 sdc _m
Low flicker	Yes
Flickering metric (Pst LM)	<1
Stroboscope effect metric (SVM)	< 0.4
Photobiological safety group acc. to EN62778	RG0
Photobiological safety group acc. to EN62471	RG0
Beam angle	120 °

¹⁾ The Panel Protect family is fulfilling the technical minimum requirements according to the German BEG subsidy program for energy efficient luminaires

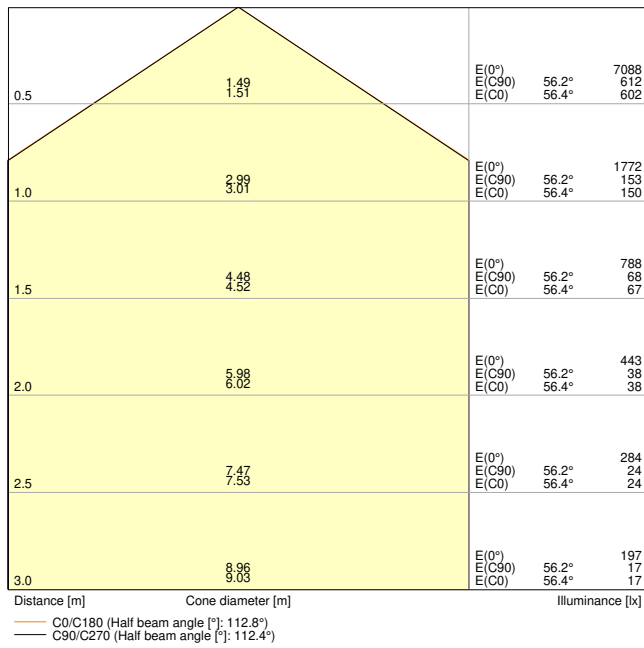

PL PROT 625 P 36W 840 DALIVR 5040lm

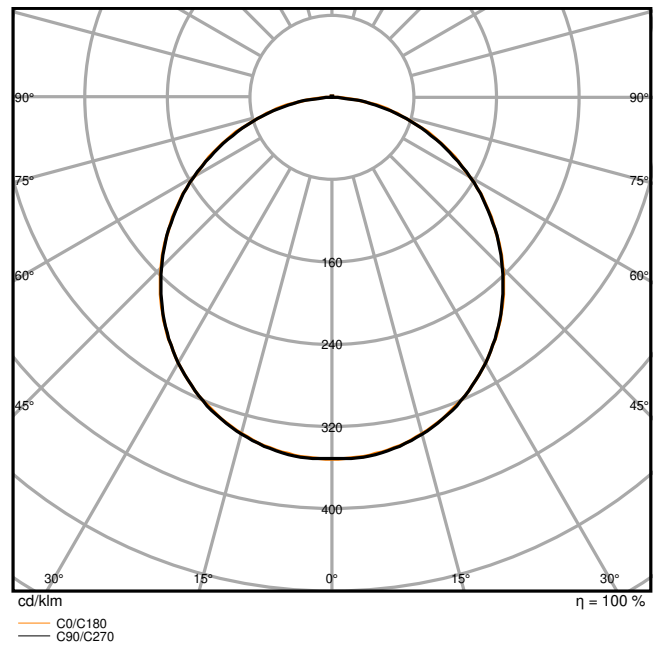

PL PROT 625 P 36W 840 DALIVR 5040lm

Dimensions & Weight

Length	620.00 mm
Width	620.00 mm
Height	34.00 mm
Product weight	2230.00 g

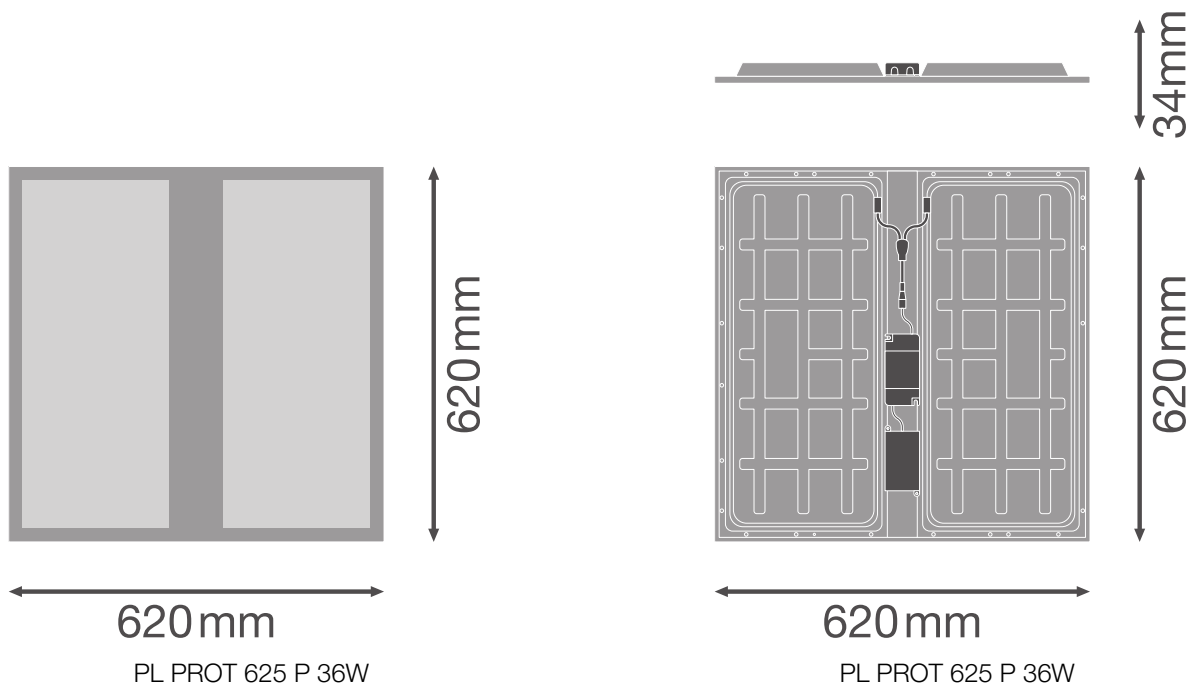

Materials & Colors

Product color	White
Housing color	White
Body material	Steel
Cover material	Polymethylmethacrylate (PMMA)
Light emitting surface material	Polymethylmethacrylate (PMMA)
Glow Wire Test according to IEC 60695-2-12	650 °C
Mercury content	0.0 mg

Application & Mounting

Ambient temperature range	-10...+50 °C
Temperature range at storage	-20...+70 °C
Type of connection	Screwless terminal, 5-Pole (L, N, PE, DA+, DA-)
Type of protection	IP54/IP20
Protection class IK (shock resistance)	IK02
Dimmable	Yes
Type of dimming	DALI2
Mounting type	Recessed/Suspended/Surface

Mounting location	Ceiling
Application environment	Indoor
Mounting length	600 mm
Mounting width	600 mm
Mounting depth	50,0 mm
Adjustable	No
With light source	Yes

Lifespan

Lifespan L70/B50 at 25 °C	100000 h ¹⁾
Lifespan L80/B10 at 25 °C	70000 h ¹⁾
Lifespan L80/B50 at 25 °C	70000 h
Lifespan L90/B10 at 25 °C	50000 h
Number of switching cycles	100000

¹⁾ t[h]: L70 / B50 @ 25 °C (Ta), t[h]: L80 / B10 @ 25 °C (Ta), t[h]: L90 / B10 @ 25 °C (Ta)

Control gear

Output current	800 mA
ECG - Output ripple current	< 5 %
ECG - Length	145 mm
ECG - Width	75,0 mm
ECG - Height	25,0 mm
Recommended control gear	OSRAM OTi_DALI_50/220-240/1A4 NFC / TRIDONIC LCA 45W 500-1400mA one4all SC PRE

Emergency lighting

Wattage in emergency operation mode	6.5 W
Luminous flux in emergency operation mode	720 lm

Certificates & Standards

Standards	CE / CB / ENEC / UKCA / EAC / EL
Luminaire with limited surface temperature, "D sign"	No
Ball shot safe	No
Replaceable light source (EPREL)	Not replaceable















Additional product data



Added function	VIVARES
----------------	---------

EQUIPMENT / ACCESSORIES

- Accessories for several mounting options available
- Connector box with 5-pole terminal pre-installed
- Security brackets preinstalled
- External control gear included
- Suitable for use with separate Emergency Conversion Box
- Special mounting frame with an overall height of only 50 mm available separately

DOWNLOAD DATA

Documents and certificates		Document name
	User instruction / safety instructions	UI PL PROT 600 P 36W and PL PROT 625 P 36W
	Legal information	Legal Insert PL PROT P
	Legal information	LSI PL PROT P 36W
	Legal information	Informationstext 18 Abs 4 ElektroG
	Legal information	EM Insert PL PROTECT
	Declarations of conformity	CE Declaration PL PROT
	Declarations of conformity UKCA	UKCA Declaration PL PROT
Photometric and lighting design files		Document name
	IES file (IES)	PL PROT 625 P 36W 840 DALIVR 5040lm
	LDT file (Eulumdat)	PL PROT 625 P 36W 840 DALIVR 5040lm
	ULD file (DIALux)	PL PROT 625 P 36W 840 DALI VR
	ROLF file (RELUX)	PL PROT 625 P 36W 840 DALI
	UGR file (UGR table)	PL PROT 625 P 36W 840 DALIVR 5040lm
	Light distribution curve type cone	PL PROT 625 P 36W 840 DALIVR 5040lm
	Light distribution curve type polar	PL PROT 625 P 36W 840 DALIVR 5040lm

CAD/BIM files		Document name
	BIM Revit 3D	PL PROT
	CAD STEP 3D	PL PROT 625

Tender texts		Document name
	Tender documents	PANEL PROTECT 625 DALI 36W 840 DALIVR-EN

LOGISTICAL DATA

Product code	Packaging unit (Pieces/Unit)	Dimensions (length x width x height)	Gross weight	Volume
4099854083440	Folding box 1	41 mm x 627 mm x 627 mm	2658.00 g	16.12 dm ³
4099854083457	Shipping box 5	645 mm x 229 mm x 656 mm	14388.00 g	96.89 dm ³

The mentioned product code describes the smallest quantity unit which can be ordered. One shipping unit can contain one or more single products. When placing an order, for the quantity please enter single or multiples of a shipping unit.

ADDITIONAL CATALOG INFORMATION

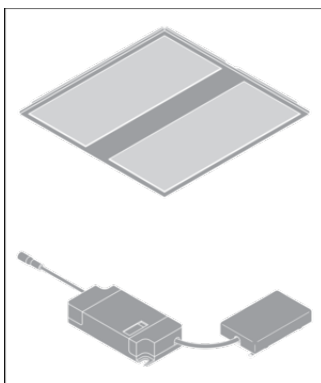
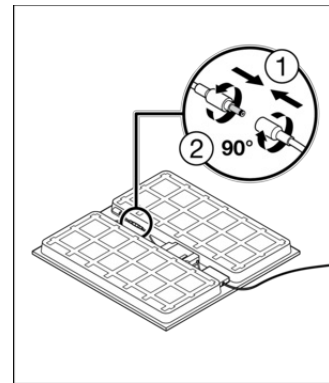
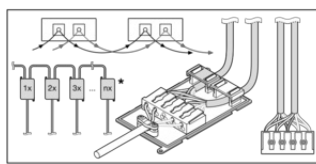
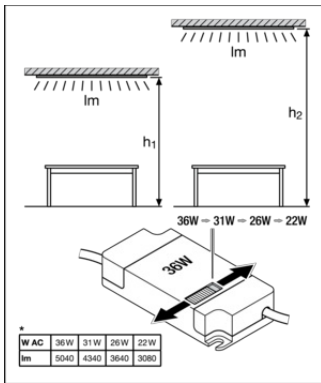

References / Links

– For Guarantee see www.ledvance.com/guarantee

DISCLAIMER

Subject to change without notice. Errors and omission excepted. Always make sure to use the most recent release.