

52220092	DATA SHEET	
Valid from: 27.04.2021	SKINTOP® MULTI VENT	

The innovative multi-cable entry SKINTOP® MULTI VENT comes with an integrated high performance pressure compensation unit that provides the ideal venting of sealed housings. The multi-cable entry is a polycarbonate shell with a gel insert as a sealing component. It provides an ideal sealing with a maximal packing density of a lot of cables with different diameters.

Due to the elastic gel membrane technology, it is possible to push the cable through and connect it directly. To ensure an optimum strain relief, the cable bundle can be fixed with help of a cable tie.



Material:

Shell: Polycarbonate (PC)
Flat seal: Gel
Pressure equalizer: Polybutylene terephthalate (PBT)

Technical characteristics:

Protection class: IP66, IP67 and IP68 (0,1bar / 60min) acc. to EN 60529
Temperature range: -30°C up to +110°C
Material features: Self-extinguishing V-2 acc. to UL 94
Oil, UV and ozone Resistant
Color: Black
Types:

Part No.	Part name	Max. number of terminals	Number of cable x cable-Ø	Pressure equalizer Air flow
52220092	SKINTOP® MULTI VENT Version 1	21	6 x 8-12 mm; 15 x 3-7 mm	0,65l/min
52220093	SKINTOP® MULTI VENT Version 2	20	4 x 2-6 mm; 8 x 4-8 mm; 3 x 5-9 mm; 2 x 8-12 mm; 1 x 12-16 mm 2 x ASI BUS oder 2 x 2-4 mm	0,65l/min
52220094	SKINTOP® MULTI VENT Version 3	29	29 x 2-6 mm	0,65l/min
52220095	SKINTOP® MULTI VENT Version 4	11	8 x 8-12 mm; 2 x 12-16mm; 1 x 16-20 mm	0,65l/min
52220160	SKINTOP® MULTI VENT Version 5	26	26x Ø4-Ø8	0,65l/min
52220162	SKINTOP® MULTI VENT Version 6	23	9x Ø2-Ø6; 8x Ø4-Ø8; 4x Ø7-Ø11; 2x Ø10-Ø14	0,65l/min

Dimensions: 46 mm x 144 mm x 14 mm
Fixing holes: 4 x 4,5mm for M4 fixing screw

Approbation:



Norm Reference:

Retention in acc. to EN 62444
Protection class acc. to EN 60529

Suitable accessory:

SKINTOP® BRUSH ADD-ON 24

Creator: THSC6/PDP Released: DAMU1/PDP	Document: DB52220092EN Version: 01	Page 1 of 4
---	---------------------------------------	-------------

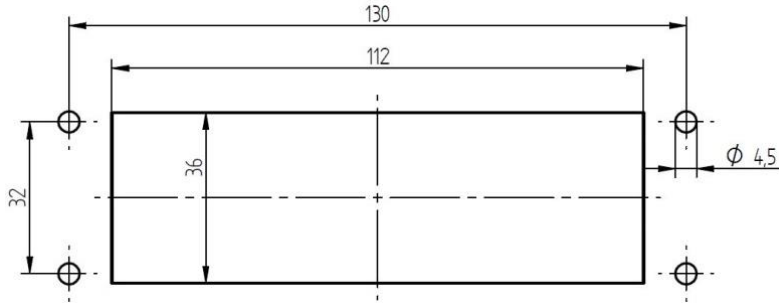
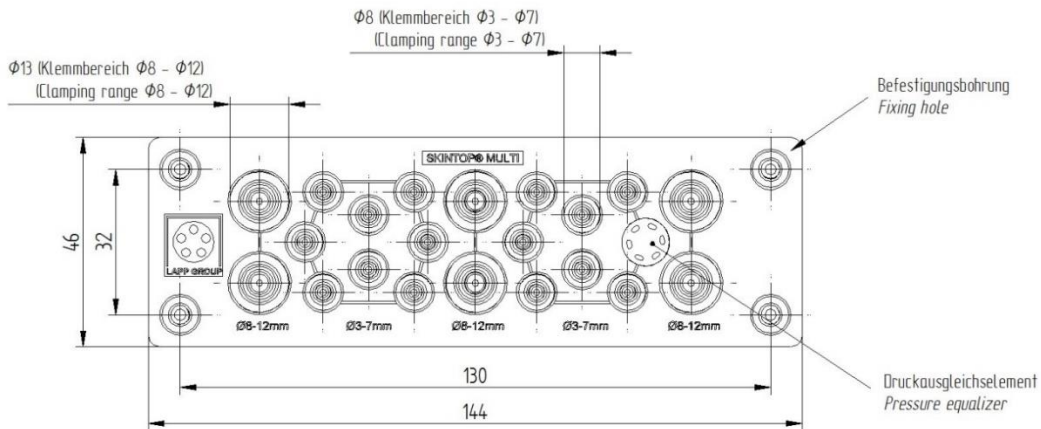
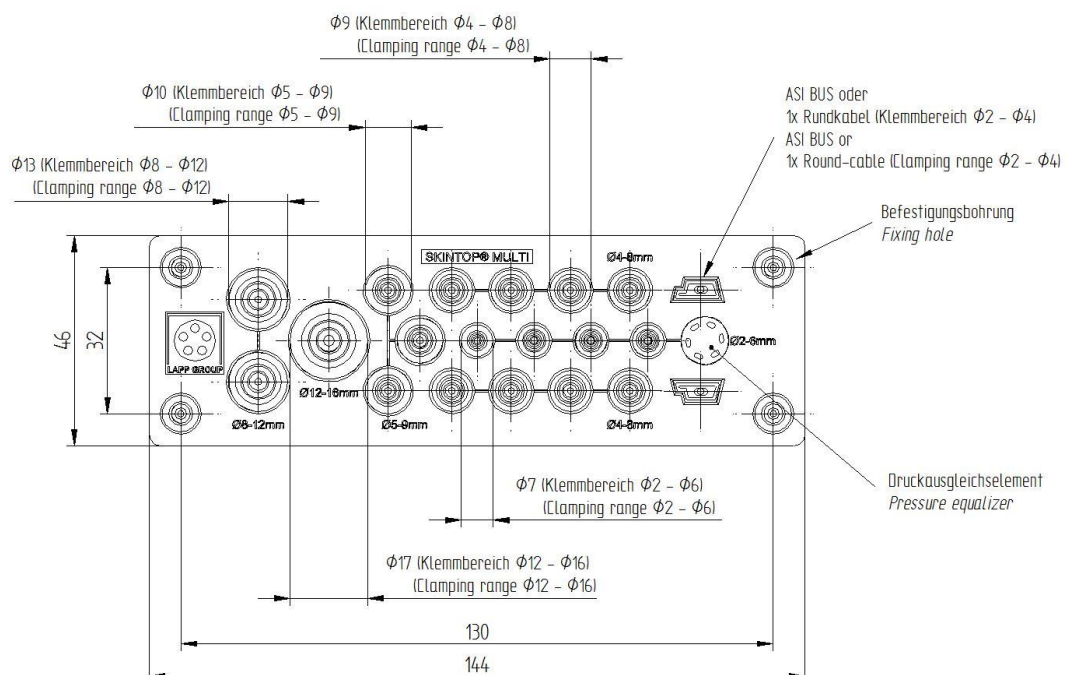
Mounting cut-out SKINTOP® MULTI VENT**SKINTOP® MULTI VENT VERSION 1****SKINTOP® MULTI VENT VERSION 2**

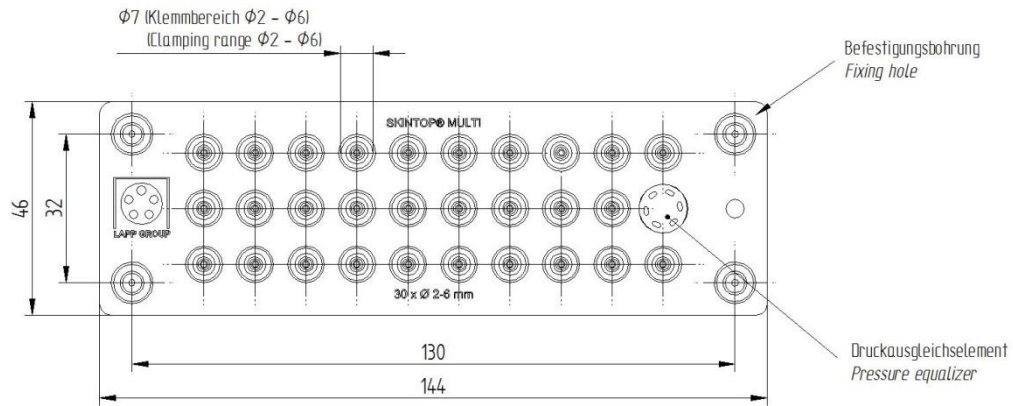
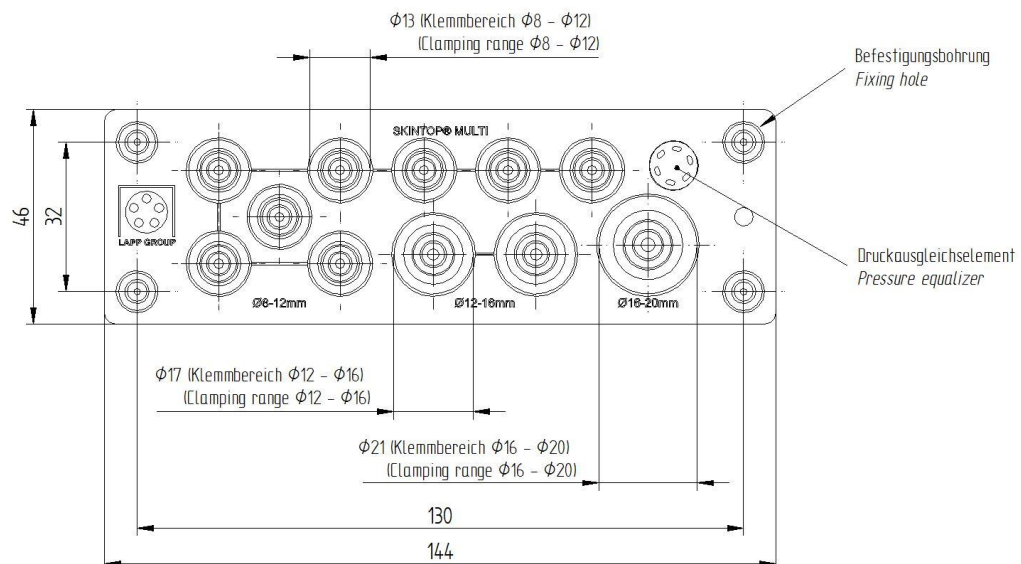
SKINTOP® MULTI VENT VERSION 3**SKINTOP® MULTI VENT VERSION 4**

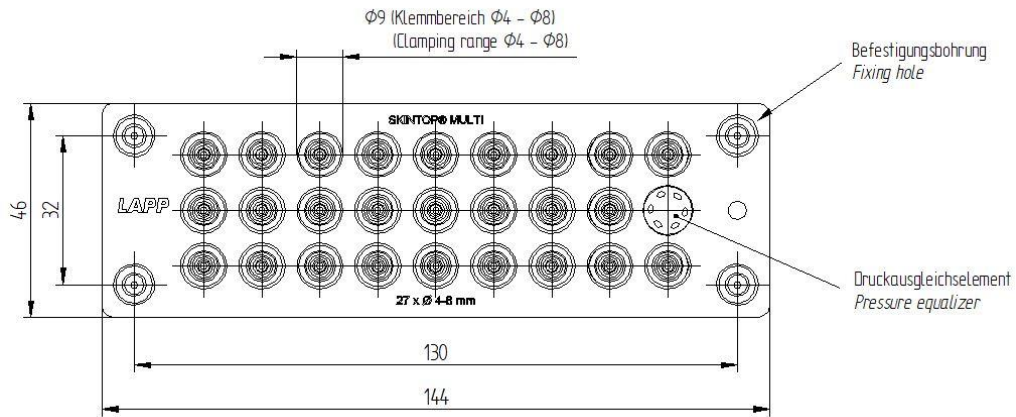
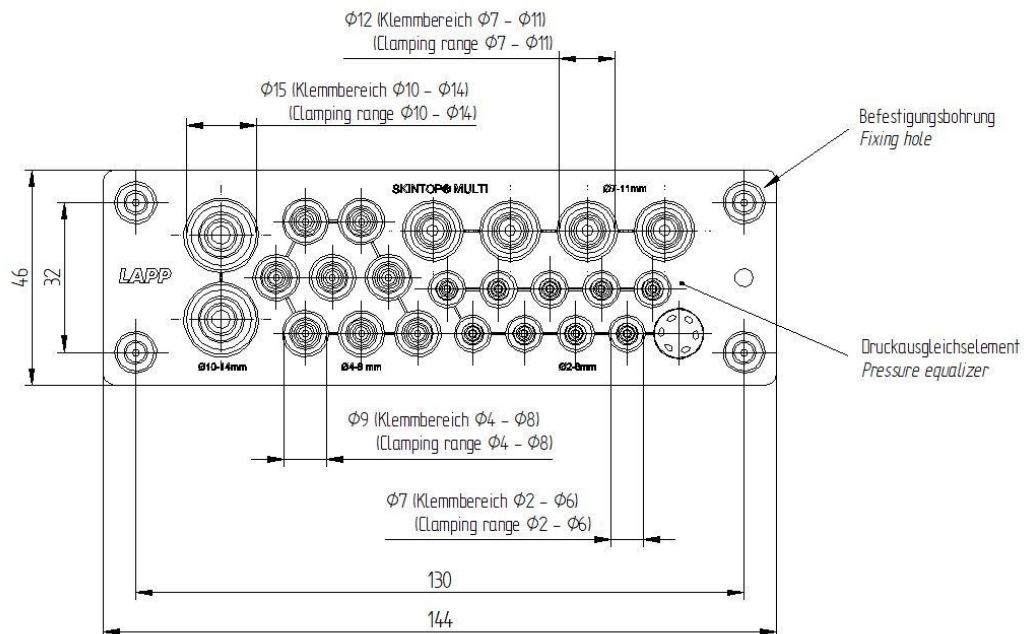
SKINTOP® MULTI VENT VERSION 5**SKINTOP® MULTI VENT VERSION 6**

For more information please see our current catalogue. Please do not hesitate to contact our laboratory if there are any questions regarding resistance against aggressive agents and special oil.