

Product Data Sheet

GWD4433

90 RCD Range



Description	RESIDUAL CURRENT CIRCUIT BREAKER
Code	IDP NA
No. of poles	4P
No. modules	4
Rated current	40 A
Rated residual operating current	300 mA
Type	AC
Rated voltage (EN/IEC 61008-1, 61008-2-1)	400/415 V

Standard	IEC/EN 61008-1, IEC/EN 61008-2-1	Rated frequency (Hz)	50Hz
Insulation voltage	500 V	Rated impulse withstand voltage	4 kV
Overvoltage category	III	Level of immunity (8/20 μs)	250 A
Section rigid cable	<=1x35 - <=2x16 - <=1x16+2x10 mm²	Section flexible cable	<=1x35 - <=2x16 - <=1x16+2x10 mm²
Rated tightening torque	2 Nm	Double connection	No
Operating temperature	-25 +60°C (40°C with derating)	Stocking temperature	-40 +70 °C
Electrical endurance	5000	Mechanical endurance	10.000
Auxiliaries compatibility	No	ReStart compatibility	No
Assembly position	Any		

DIMENSIONAL

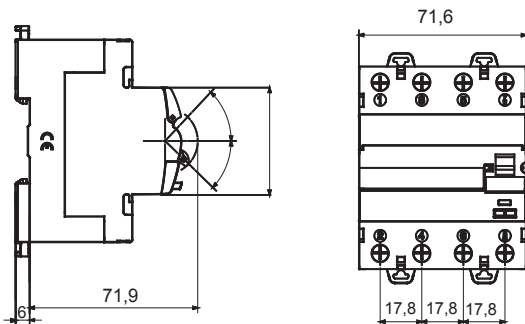

WIRING DIAGRAM



STANDARDS/APPROVALS

