

PRODUCT DATASHEET

LN INV D 1200 P 40W 940 PS WT

LINEAR INDIVILED DIRECT 1200 PS | Surface mounted luminaire for single or light line office application with CRI90 and power select (PS) feature, 1200 mm



Areas of application

- Direct replacement for luminaires with fluorescent lamps
- Offices, education, public buildings
- Single and continuous line configuration
- Direct lighting

Product benefits

- Easy upgradeability of light source and driver (EVERLOOP design)
- Homogenous light distribution and reduced glare ($UGR \leq 19$) thanks to IndiviLED® optics
- High performance with CRI90 and up to 130 lm/W
- Highly versatile due to selectable power steps (Power Select - PS) on the driver
- Symmetric and asymmetric light distribution for various application areas
- High color consistency with SDCM 3
- Easy installation
- Low flicker light thanks to special electronic control gear
- Multiple mounting options thanks to different accessories

Product features

- Minimalistic LEDVANCE SCALE design in extruded aluminum housing, available in white and black color
- Includes EVERLOOP: Convenient replacement of light source and LED driver
- Linkable into seamless light line with accessories (surface or pendant mounting)



- Pendant mounting with suspension kit (to be ordered separately)
- Glow Wire Test according to IEC 60695-2-12: 850 °C
- 5-pole terminal block, cable cross section up to 5 x 2.5 mm²
- Lifetime (L80/B10): 70,000 h (at 25 °C)

TECHNICAL DATA

Electrical data

Nominal wattage	40 W / 36 W / 30 W / 25 W
Nominal voltage	220...240 V
Mains frequency	50...60 Hz
Nominal current	185...170...140...120 mA
Inrush current	15 A
Inrush current time T_{h50}	50 μ s
Max. number of luminaires per miniature circuit breaker B16	50
Max. number of luminaires per miniature circuit breaker C10	36
Max. number of luminaires per miniature circuit breaker C16	58
Power factor λ	≥ 0.90
Total harmonic distortion	≤ 20 %
Protection class	I
Operating mode	Integrated LED driver

Photometrical data

Luminous flux	5050 lm / 4600 lm / 3900 lm / 3250 lm
Luminous efficacy	126 lm/W / 128 lm/W / 130 lm/W
Color temperature	4000 K
Light color (designation)	Cool White
Color rendering index Ra	> 90
Standard deviation of color matching	3 sdc _m
Low flicker	Yes
Flickering metric (Pst LM)	≤ 1
Stroboscope effect metric (SVM)	≤ 0.4
Photobiological safety group acc. to EN62778	RG0
Photobiological safety group acc. to EN62471	RG0
Beam angle	90 °
UGR	< 19

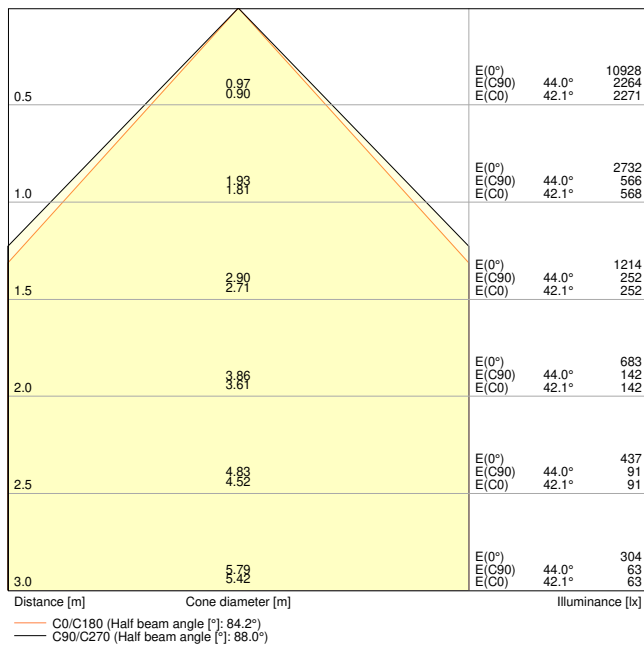

LN INV D 1200 P 40W 940 PS WT 800mA

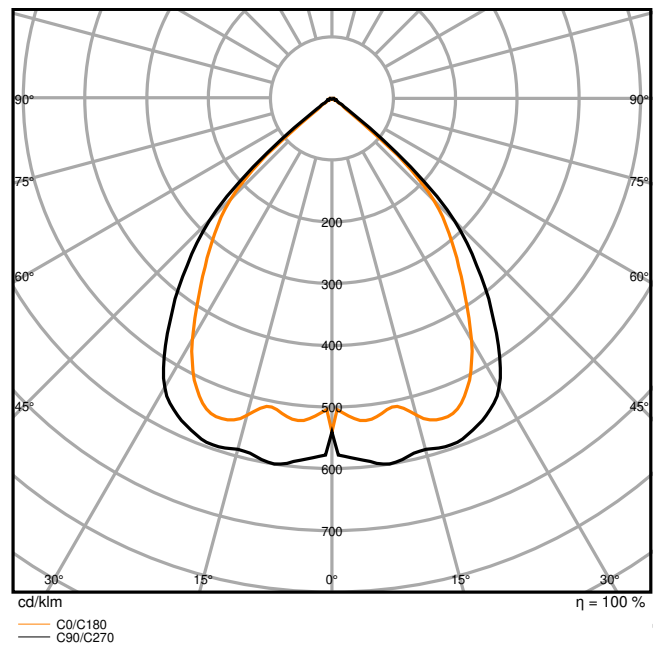

LN INV D 1200 P 40W 940 PS WT 800mA

Dimensions & Weight

Length	1210.00 mm
Width	125.00 mm
Height	43.00 mm
Product weight	3200.00 g

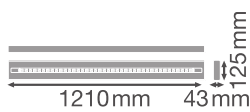

LN INV 1200 P

Materials & Colors

Product color	White
Housing color	White
Body material	Aluminum
Cover material	Polymethylmethacrylate (PMMA)
Light emitting surface material	Polymethylmethacrylate (PMMA)
Glow Wire Test according to IEC 60695-2-12	850 °C
Mercury content	0.0 mg

Application & Mounting

Ambient temperature range	-20...+50 °C
Temperature range at storage	-20...+80 °C
Type of connection	Screwless terminal, 5-Pole (L, N, PE, DA+, DA-)
Type of protection	IP20
Protection class IK (shock resistance)	IK06
Dimmable	No
Mounting type	Suspended/Surface
Mounting location	Ceiling
Application environment	Indoor
Adjustable	No
With light source	Yes

Lifespan

Lifespan L70/B50 at 25 °C	100000 h ¹⁾
Lifespan L80/B10 at 25 °C	70000 h ¹⁾
Lifespan L80/B50 at 25 °C	70000 h
Lifespan L90/B10 at 25 °C	35000 h
Number of switching cycles	25000

¹⁾ t[h]: L70 / B50 @ 25 °C (Ta), t[h]: L80 / B10 @ 25 °C (Ta), t[h]: L90 / B10 @ 25 °C (Ta)

Control gear

Output current	800 mA
ECG - Output ripple current	≤ 5 %
Recommended control gear	OSRAM type IT FIT 40/220-240/800 CS L

Certificates & Standards

Standards	CE / CB / ENEC / TÜV SÜD / UKCA / EAC / EPD
-----------	---

Luminaire with limited surface temperature, "D sign"	No
Ball shot safe	No
EPD	LEDV-00027-V01.01-EN
Replaceable light source (EPREL)	By the end consumer

Additional product data

Number of illuminants	1
Added function	EVERLOOP / MULTI SELECT

Accessories Optional

Product image	Product name	EAN
	LN INV CORNER CONNECTOR WT	4099854214905
	LN INV SUSPENSION WIRE	4099854215551
	LN INV 1200 THROUGHWIRING KIT	4099854214820
	LN INV INFILL 1500 WT	4099854214844
	LN INV INFILL 600 WT	4099854214882
	LN INV INFILL 1200 WT	4099854214868
	LN INV INLINE CONNECTOR	4099854215612

Product image	Product name	EAN
	LN INV SUSPENSION KIT WT	4099854215537









EQUIPMENT / ACCESSORIES







- Suspension kit available for pendant luminaire version (to be ordered separately)
- Inline, corner and infill connectors available as separate accessory
- Through-wiring cable kit available



Safety advice

- All electrical connections must be made by a qualified person.
- If the external flexible cable or cord of this luminaire is damaged, it shall be exclusively replaced by a qualified person in order to avoid a hazard.
- Caution, risk of electric shock.
- Product in protection class I. All electrically conductive, metallic housing parts that can absorb voltage during operation or during maintenance in the event of a fault must be continuously connected to the protective earthing conductor.

DOWNLOAD DATA

Documents and certificates		Document name
	User instruction / safety instructions	LN INV
	Legal information	LN INV PS
	Legal information	LSI LN INDIVLED
	Legal information	Legal Insert LN INV P PS
	Legal information	Informationstext 18 Abs 4 ElektroG
	Declarations of conformity	LN INV
	Declarations of conformity UKCA	LN INV
Photometric and lighting design files		Document name
	IES file (IES)	LN INV D 1200 P 40W 940 PS WT 800mA

Photometric and lighting design files		Document name
	LDT file (Eulumdat)	LN INV D 1200 P 40W 940 PS WT 800mA
	ULD file (DIALux)	LN INV D 1200 P 40W 940 PS WT
	ROLF file (RELUX)	LN INV D 1200 P 40W 940 PS WT
	UGR file (UGR table)	LN INV D 1200 P 40W 940 PS WT 800mA
	Light distribution curve type cone	LN INV D 1200 P 40W 940 PS WT 800mA
	Light distribution curve type polar	LN INV D 1200 P 40W 940 PS WT 800mA

CAD/BIM files		Document name
	BIM Revit 3D	Linear Indiviled G2
	CAD STEP 3D	LN INV D 1200 G2

Tender texts	Document name
	Tender documents LINEAR INDIVILED DIRECT 1200 PS 1200 P 40W 940 PS WT-EN

LOGISTICAL DATA

Product code	Packaging unit (Pieces/Unit)	Dimensions (length x width x height)	Gross weight	Volume
4099854135330	Folding box 1	178 mm x 1,263 mm x 103 mm	3800.00 g	23.16 dm ³
4099854135347	Shipping box 2	1,277 mm x 187 mm x 189 mm	9000.00 g	45.13 dm ³

The mentioned product code describes the smallest quantity unit which can be ordered. One shipping unit can contain one or more single products. When placing an order, for the quantity please enter single or multiples of a shipping unit.

ADDITIONAL CATALOG INFORMATION

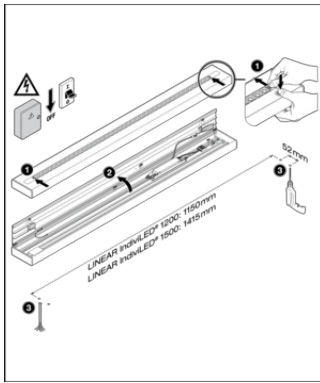

LINEAR INDIVILED® DIRECT WT		DRIVER		AS ORDER		Presel	mA	W	lm	lm/W
		Plu.1	Plu.2							
LN INV D 1200 P 40W 930 PS WT	CSRAM	OFF	OFF	-	800	25	3700	126		
	ET-FIT-40	ON	ON	-	800	25	3700	126		
	SRV-CS-L	ON	ON	-	700	38	4400	120		
LN INV D 1200 P 40W 940 PS WT	CSRAM	OFF	OFF	-	800	42	4800	120		
	ET-FIT-40	ON	ON	-	800	25	3700	126		
	SRV-CS-L	ON	ON	Presel	800	30	3900	130		
LN INV D 1500 P 32W 830 PS WT	CSRAM	OFF	OFF	-	800	40	4800	121		
	ET-FIT-40	ON	ON	-	800	40	4800	121		
	SRV-CS-L	ON	ON	Presel	575	48	5000	118		
LN INV D 1500 P 32W 840 PS WT	CSRAM	OFF	OFF	-	800	42	5000	120		
	ET-FIT-40	ON	ON	-	800	42	5000	120		
	SRV-CS-L	ON	ON	Presel	575	48	5100	127		
LN INV D 1500 P 32W 840 PS WT	CSRAM	OFF	OFF	-	800	42	5000	120		
	ET-FIT-40	ON	ON	-	800	42	5000	120		
	SRV-CS-L	ON	ON	Presel	575	48	5100	127		

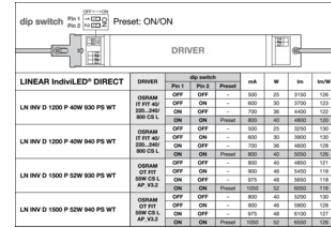

LINEAR INDIVILED® DIRECT		DRIVER		AS ORDER		Presel	mA	W	lm	lm/W
		Plu.1	Plu.2							
LN INV D 1200 P 40W 930 PS WT	CSRAM	OFF	OFF	-	800	25	3700	126		
	ET-FIT-40	ON	ON	-	800	25	3700	126		
	SRV-CS-L	ON	ON	-	700	38	4400	120		
LN INV D 1200 P 40W 940 PS WT	CSRAM	OFF	OFF	-	800	42	4800	120		
	ET-FIT-40	ON	ON	-	800	25	3700	126		
	SRV-CS-L	ON	ON	Presel	800	30	3900	130		
LN INV D 1500 P 32W 830 PS WT	CSRAM	OFF	OFF	-	800	40	4800	121		
	ET-FIT-40	ON	ON	-	800	40	4800	121		
	SRV-CS-L	ON	ON	Presel	575	48	5000	118		
LN INV D 1500 P 32W 840 PS WT	CSRAM	OFF	OFF	-	800	42	5000	120		
	ET-FIT-40	ON	ON	-	800	42	5000	120		
	SRV-CS-L	ON	ON	Presel	575	48	5100	127		

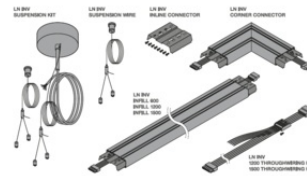
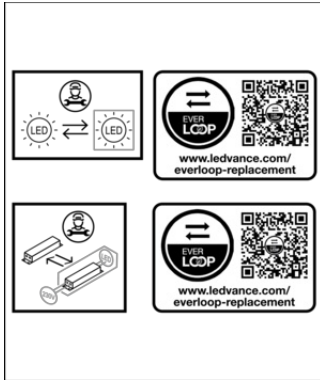

References / Links

- For Guarantee see www.ledvance.com/guarantee

DISCLAIMER

Subject to change without notice. Errors and omission excepted. Always make sure to use the most recent release.