

# PRODUCT DATASHEET

## LN INV D 1500 P 52W 930 PS WT

LINEAR INDIVILED DIRECT 1500 PS | Surface mounted luminaire for single or light line office application with CRI90 and power select (PS) feature, 1500 mm



### Areas of application

- Direct replacement for luminaires with fluorescent lamps
- Offices, education, public buildings
- Single and continuous line configuration
- Direct lighting

### Product benefits

- Easy upgradeability of light source and driver (EVERLOOP design)
- Homogenous light distribution and reduced glare ( $UGR \leq 19$ ) thanks to IndiviLED® optics
- High performance with CRI90 and up to 130 lm/W
- Highly versatile due to selectable power steps (Power Select - PS) on the driver
- Symmetric and asymmetric light distribution for various application areas
- High color consistency with SDCM 3
- Easy installation
- Low flicker light thanks to special electronic control gear
- Multiple mounting options thanks to different accessories

### Product features

- Minimalistic LEDVANCE SCALE design in extruded aluminum housing, available in white and black color
- Includes EVERLOOP: Convenient replacement of light source and LED driver
- Linkable into seamless light line with accessories (surface or pendant mounting)



- Pendant mounting with suspension kit (to be ordered separately)
- Glow Wire Test according to IEC 60695-2-12: 850 °C
- 5-pole terminal block, cable cross section up to 5 x 2.5 mm<sup>2</sup>
- Lifetime (L80/B10): 70,000 h (at 25 °C)

## TECHNICAL DATA

### Electrical data

Nominal wattage	52 W / 48 W / 46.0 W / 40 W
Nominal voltage	220...240 V
Mains frequency	50...60 Hz
Nominal current	240...220...205...185 mA
Inrush current	14.6 A
Inrush current time $T_{h50}$	170 $\mu$ s
Max. number of luminaires per miniature circuit breaker B16	28
Max. number of luminaires per miniature circuit breaker C10	23
Max. number of luminaires per miniature circuit breaker C16	38
Power factor $\lambda$	$\geq 0.90$
Total harmonic distortion	$\leq 20$ %
Protection class	I
Operating mode	Integrated LED driver

### Photometrical data

Luminous flux	6050 lm / 5650 lm / 5450 lm / 4850 lm
Luminous efficacy	116 lm/W / 118 lm/W / 121 lm/W
Color temperature	3000 K
Light color (designation)	Warm White
Color rendering index Ra	> 90
Standard deviation of color matching	3 sdc <sub>m</sub>
Low flicker	Yes
Flickering metric (Pst LM)	$\leq 1$
Stroboscope effect metric (SVM)	$\leq 0.4$
Photobiological safety group acc. to EN62778	RG0
Photobiological safety group acc. to EN62471	RG0
Beam angle	90 °
UGR	< 19

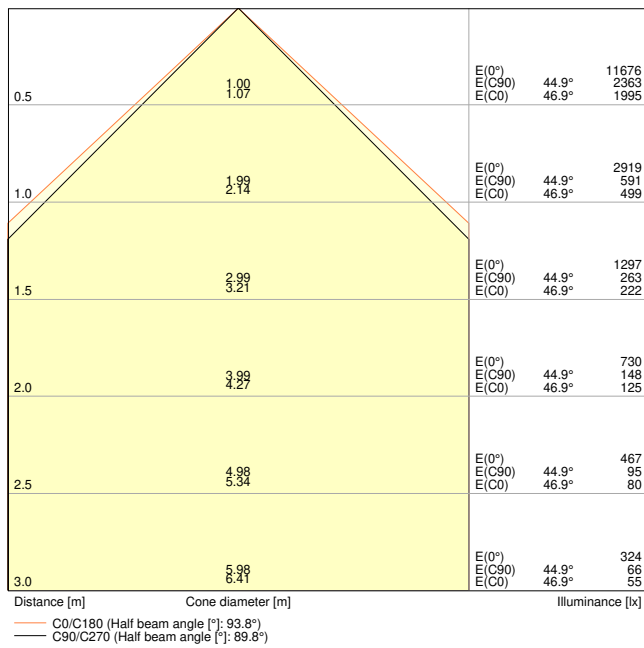

LN INV D 1500 P 52W 930 PS WT 1050mA

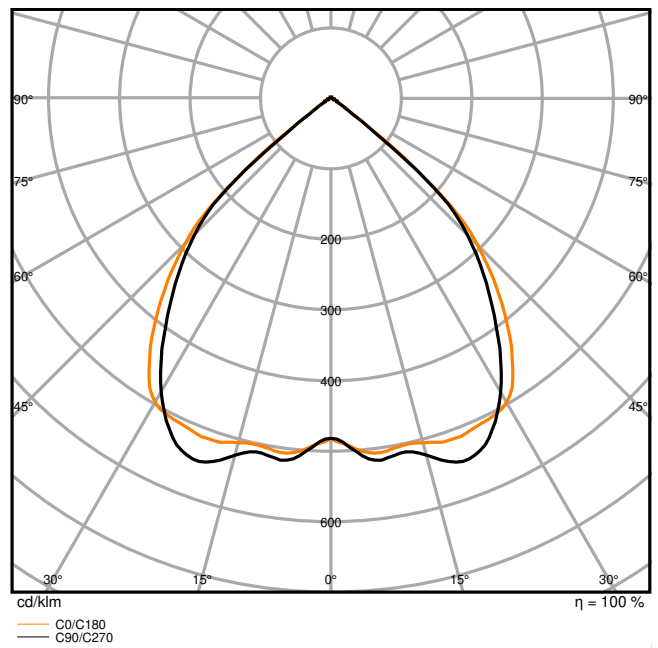

LN INV D 1500 P 52W 930 PS WT 1050mA

Dimensions & Weight

Length	1475.00 mm
Width	125.00 mm
Height	43.00 mm
Product weight	3960.00 g

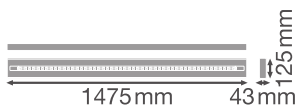

LN INV 1500 P

Materials & Colors

Product color	White
Housing color	White
Body material	Aluminum
Cover material	Polymethylmethacrylate (PMMA)
Light emitting surface material	Polymethylmethacrylate (PMMA)
Glow Wire Test according to IEC 60695-2-12	850 °C
Mercury content	0.0 mg

### Application & Mounting

Ambient temperature range	-20...+50 °C
Temperature range at storage	-20...+80 °C
Type of connection	Screwless terminal, 5-Pole (L, N, PE, DA+, DA-)
Type of protection	IP20
Protection class IK (shock resistance)	IK06
Dimmable	No
Mounting type	Suspended/Surface
Mounting location	Ceiling
Application environment	Indoor
Adjustable	No
With light source	Yes

### Lifespan

Lifespan L70/B50 at 25 °C	100000 h <sup>1)</sup>
Lifespan L80/B10 at 25 °C	70000 h <sup>1)</sup>
Lifespan L80/B50 at 25 °C	70000 h
Lifespan L90/B10 at 25 °C	35000 h
Number of switching cycles	25000

<sup>1)</sup> t[h]: L70 / B50 @ 25 °C (Ta), t[h]: L80 / B10 @ 25 °C (Ta), t[h]: L90 / B10 @ 25 °C (Ta)

### Control gear

Output current	1050 mA
ECG - Output ripple current	≤ 5 %
Recommended control gear	OSRAM OT FIT 55/220-240/1A0 CS L AP

### Certificates & Standards

Standards	CE / CB / ENEC / TÜV SÜD / UKCA / EAC / EPD
-----------	---

Luminaire with limited surface temperature, "D sign"	No
Ball shot safe	No
EPD	LEDV-00027-V01.01-EN
Replaceable light source (EPREL)	By the end consumer

Additional product data

Number of illuminants	1
Added function	EVERLOOP / MULTI SELECT

Accessories Optional

Product image	Product name	EAN
	LN INV CORNER CONNECTOR WT	4099854214905
	LN INV SUSPENSION WIRE	4099854215551
	LN INV 1500 THROUGHWIRING KIT	4099854214806
	LN INV INFILL 1500 WT	4099854214844
	LN INV INFILL 600 WT	4099854214882
	LN INV INFILL 1200 WT	4099854214868
	LN INV INLINE CONNECTOR	4099854215612

Product image	Product name	EAN
	LN INV SUSPENSION KIT WT	4099854215537









## EQUIPMENT / ACCESSORIES







- Suspension kit available for pendant luminaire version (to be ordered separately)
- Inline, corner and infill connectors available as separate accessory
- Through-wiring cable kit available



## Safety advice

- All electrical connections must be made by a qualified person.
- If the external flexible cable or cord of this luminaire is damaged, it shall be exclusively replaced by a qualified person in order to avoid a hazard.
- Caution, risk of electric shock.
- Product in protection class I. All electrically conductive, metallic housing parts that can absorb voltage during operation or during maintenance in the event of a fault must be continuously connected to the protective earthing conductor.

## DOWNLOAD DATA

Documents and certificates		Document name
	User instruction / safety instructions	LN INV
	Legal information	LN INV PS
	Legal information	LSI LN INDIVLED
	Legal information	Legal Insert LN INV P PS
	Legal information	Informationstext 18 Abs 4 ElektroG
	Declarations of conformity	LN INV
	Declarations of conformity UKCA	LN INV
Photometric and lighting design files		Document name
	IES file (IES)	LN INV D 1500 P 52W 930 PS WT 1050mA

Photometric and lighting design files		Document name
	LDT file (Eulumdat)	LN INV D 1500 P 52W 930 PS WT 1050mA
	ULD file (DIALux)	LN INV D 1500 P 52W 930 PS WT
	ROLF file (RELUX)	LN INV D 1500 P 52W 930 PS WT
	UGR file (UGR table)	LN INV D 1500 P 52W 930 PS WT 1050mA
	Light distribution curve type cone	LN INV D 1500 P 52W 930 PS WT 1050mA
	Light distribution curve type polar	LN INV D 1500 P 52W 930 PS WT 1050mA

CAD/BIM files		Document name
	BIM Revit 3D	Linear Indiviled G2
	CAD STEP 3D	LN INV D 1500 G2

Tender texts		Document name
	Tender documents	LINEAR INDIVILED DIRECT 1500 PS 1500 P 52W 930 PS WT-EN

**LOGISTICAL DATA**

Product code	Packaging unit (Pieces/Unit)	Dimensions (length x width x height)	Gross weight	Volume
4099854135477	Folding box 1	1,252 mm x 167 mm x 87 mm	4660.00 g	18.19 dm <sup>3</sup>
4099854135484	Shipping box 2	1,547 mm x 187 mm x 189 mm	10920.00 g	54.68 dm <sup>3</sup>

The mentioned product code describes the smallest quantity unit which can be ordered. One shipping unit can contain one or more single products. When placing an order, for the quantity please enter single or multiples of a shipping unit.

**ADDITIONAL CATALOG INFORMATION**



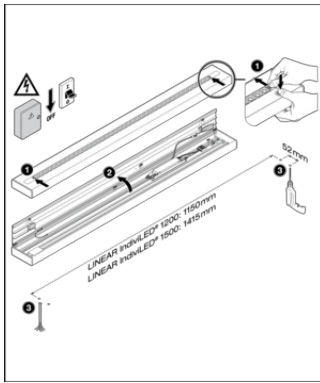

LINEAR INDIVILED® DIRECT WT	DRIVER	AS SUPPLY			mA	W	lm	lm/W
		Pin 1	Pin 2	Preset				
LN INV D 1500 P 40W 930 PS WT	CSRAM	OFF	OFF	-	800	25	3700	126
	ET-FIT-90	ON	ON	-	800	25	3700	126
	SRV-CE-L	ON	OFF	-	700	38	4400	120
LN INV D 1500 P 40W 940 PS WT	CSRAM	OFF	OFF	-	800	40	4800	120
	ET-FIT-90	ON	ON	-	800	40	4800	120
	SRV-CE-L	ON	OFF	-	700	38	4800	128
LN INV D 1500 P 52W 930 PS WT	CSRAM	OFF	OFF	-	800	40	4800	121
	ET-FIT-90	ON	ON	-	800	40	4800	119
	SRV-CE-L	ON	OFF	-	875	48	5000	118
LN INV D 1500 P 52W 940 PS WT	CSRAM	OFF	OFF	-	800	40	5000	120
	ET-FIT-90	ON	ON	-	800	40	5000	120
	SRV-CE-L	ON	OFF	-	875	48	5100	127
LN INV D 1500 P 52W 940 PS WT	CSRAM	OFF	OFF	-	800	50	5000	126
	ET-FIT-90	ON	ON	-	800	50	5000	126
	SRV-CE-L	ON	OFF	-	875	50	5000	126

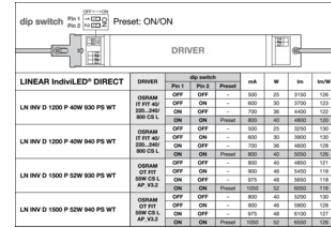

LINEAR INDIVILED® DIRECT	DRIVER	AS SUPPLY			mA	W	lm	lm/W
		Pin 1	Pin 2	Preset				
LN INV D 1500 P 40W 930 PS WT	CSRAM	OFF	OFF	-	800	25	3700	126
	ET-FIT-90	ON	ON	-	800	25	3700	126
	SRV-CE-L	ON	OFF	-	700	38	4400	120
LN INV D 1500 P 40W 940 PS WT	CSRAM	OFF	OFF	-	800	40	4800	120
	ET-FIT-90	ON	ON	-	800	40	4800	120
	SRV-CE-L	ON	OFF	-	700	38	4800	128
LN INV D 1500 P 52W 930 PS WT	CSRAM	OFF	OFF	-	800	40	4800	121
	ET-FIT-90	ON	ON	-	800	40	4800	119
	SRV-CE-L	ON	OFF	-	875	48	5000	118
LN INV D 1500 P 52W 940 PS WT	CSRAM	OFF	OFF	-	800	40	5000	120
	ET-FIT-90	ON	ON	-	800	40	5000	120
	SRV-CE-L	ON	OFF	-	875	48	5100	127
LN INV D 1500 P 52W 940 PS WT	CSRAM	OFF	OFF	-	800	50	5000	126
	ET-FIT-90	ON	ON	-	800	50	5000	126
	SRV-CE-L	ON	OFF	-	875	50	5000	126

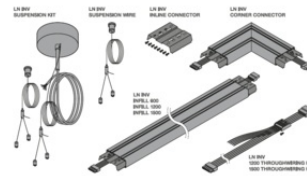
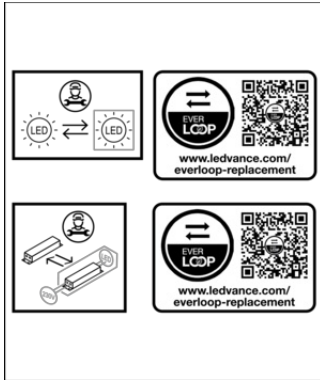

### References / Links

- For Guarantee see [www.ledvance.com/guarantee](http://www.ledvance.com/guarantee)

### DISCLAIMER

Subject to change without notice. Errors and omission excepted. Always make sure to use the most recent release.