

# PRODUCT DATASHEET

## FL PFM DA SYM R30 200W 4000K BK

FLOODLIGHT PERFORMANCE DALI SYM R30 | DALI 2.0 based floodlight with rotational symmetric light distribution for high mast area lighting



### Areas of application

- Direct replacement for luminaires using HID lamps
- Outdoor use (IP66)
- Parking
- Public areas
- Industry
- Sports facilities
- Lighting of large areas
- D-sign according to EN 60598-2-24 for fire-risk commercial unit, e.g. by accumulation of dust

### Product benefits

- Energy savings of up to 90 % compared to halogen lamp floodlights
- Energy savings of up to 45 % compared to luminaires that use conventional discharge lamps
- Bright, robust and durable
- Homogeneous luminance distribution and reduced glare
- No upper light output ratio (ULOR 0%) when mounted at 0° tilt
- Key hole to ensure ease of installation
- 5 years guarantee

### Product features

- DALI 2.0 interface for light management system integration
- High luminous efficacy: up to 140 lm/W
- Rotational symmetric light distribution for high mast area lighting
- Angled (45°) mounting bracket and up to 180° tilting
- High surge protection: up to 10 kV (L/N-PE), 6 kV (L-N)



- Integrated breather for preventing condensation inside the luminaire
- Connection via 2 m cable, wiring required
- Type of protection: IP66
- Impact resistance: IK08
- Ambient temperature in operation: -30...+50 °C

## TECHNICAL DATA

### Electrical data

Nominal wattage	200.00 W
Nominal voltage	220...240 V
Mains frequency	50...60 Hz
Nominal current	980.000 mA
Inrush current	110 A
Inrush current time $T_{h50}$	350 $\mu$ s
Max. number of luminaires per miniature circuit breaker B16	2
Max. number of luminaires per miniature circuit breaker C10	2
Max. number of luminaires per miniature circuit breaker C16	4
Power factor $\lambda$	> 0.90
Total harmonic distortion	< 10 %
Protection class	I
Operating mode	Integrated LED driver
Dimming interface	DALI-2

### Photometrical data

Luminous flux	26800 lm
Luminous efficacy	134 lm/W
Color temperature	4000 K
Light color (designation)	Cool White
Color rendering index Ra	> 80
Standard deviation of color matching	$\leq$ 5 sdc <sub>m</sub>
Low flicker	Yes
Photobiological safety group acc. to EN62778	RG1
Photobiological safety group acc. to EN62471	RG1
Beam angle	30 °

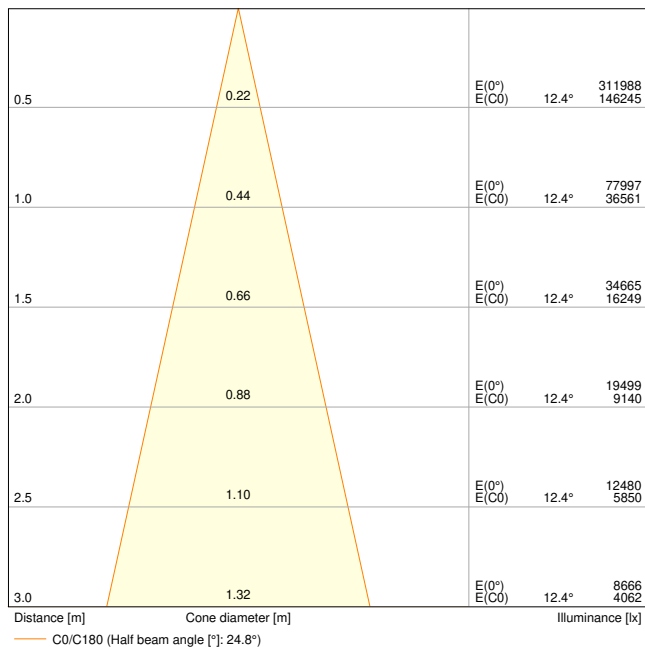

FL PFM DA 200W 4000K SYM R30 BK

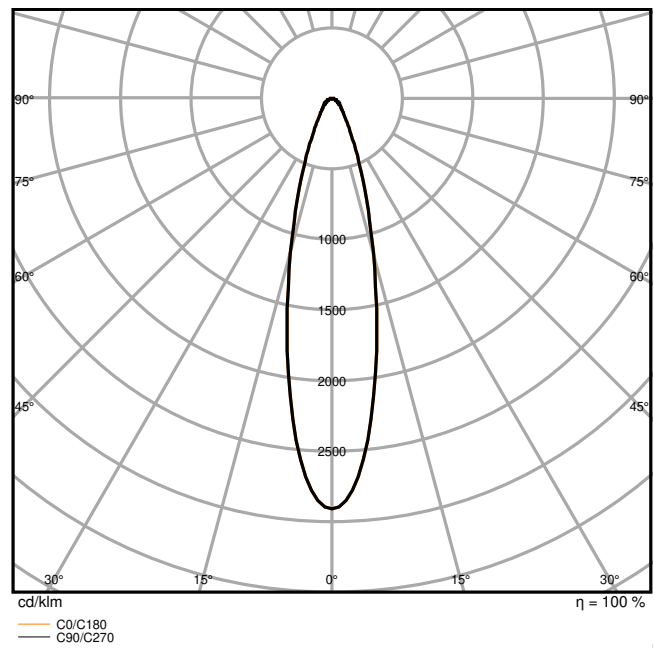

FL PFM DA 200W 4000K SYM R30 BK

### Dimensions & Weight

Length	494.00 mm
Width	395.00 mm
Height	87.00 mm
Product weight	7000.00 g
Cable length	2000 mm

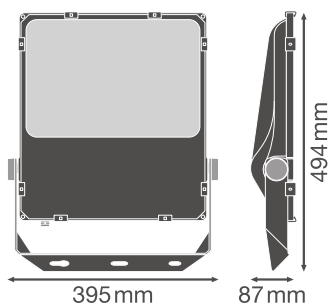

FL PFM 200W BK

### Materials & Colors

Product color	Black
Housing color	Black
Body material	Aluminum
Cover material	Glass
Light emitting surface material	Glass
Glow Wire Test according to IEC 60695-2-12	650 °C
Mercury content	0.0 mg

### Application & Mounting

Ambient temperature range	-30...+50 °C
Temperature range at storage	-40...+70 °C
Type of connection	Cable, 5-pole
Type of protection	IP66
Protection class IK (shock resistance)	IK08
Dimmable	Yes
Type of dimming	DALI
Mounting type	Surface
Mounting location	Wall / Pole / Floor / Ceiling
Application environment	Outdoor
Adjustable	Yes
With light source	Yes

### Lifespan

Lifespan L70/B50 at 25 °C	100000 h <sup>1)</sup>
Lifespan L80/B10 at 25 °C	70000 h <sup>1)</sup>
Lifespan L80/B50 at 25 °C	70000 h
Lifespan L90/B10 at 25 °C	30000 h
Number of switching cycles	100000

<sup>1)</sup> t[h]: L70 / B50 @ 25 °C (Ta), t[h]: L80 / B10 @ 25 °C (Ta), t[h]: L90 / B10 @ 25 °C (Ta)

### Control gear







ECG - Output ripple current	< 10 %
-----------------------------	--------







### Certificates & Standards

Standards	CE / CB / ENEC / TÜV SÜD / UKCA / EAC
Luminaire with limited surface temperature, "D sign"	Yes

Ball shot safe	No
Replaceable light source (EPREL)	Not replaceable

DOWNLOAD DATA

Documents and certificates		Document name
	User instruction / safety instructions	FLOODLIGHT PERFORMANCE DALI
	Legal information	LSI Floodlight PFM DALI
	Legal information	Legal Insert FL PFM DA
	Legal information	Informationstext 18 Abs 4 ElektroG
	Declarations of conformity	CE Declaration of Conformity FLOODLIGHT PFM DA BK
	Declarations of conformity UKCA	UKCA Declaration of Conformity FLOODLIGHT PFM DA BK
	Certificates	FL PFM DA

Photometric and lighting design files		Document name
	IES file (IES)	FL PFM DA 200W 4000K SYM R30 BK
	LDT file (Eulumdat)	FL PFM DA 200W 4000K SYM R30 BK
	ULD file (DIALux)	FL PFM DA 200W 4000K SYM
	ROLF file (RELUX)	FL PFM DA 200W 4000K SYM
	UGR file (UGR table)	FL PFM DA 200W 4000K SYM R30 BK
	Light distribution curve type cone	FL PFM DA 200W 4000K SYM R30 BK
	Light distribution curve type polar	FL PFM DA 200W 4000K SYM R30 BK

CAD/BIM files		Document name
	BIM Revit 3D	FL PFM

CAD/BIM files		Document name
	CAD STEP 3D	FL PFM 200W

---

Tender texts		Document name
	Tender documents	FLOODLIGHT PERFORMANCE DALI SYM R30 200W 4000K BK-EN

**LOGISTICAL DATA**

Product code	Packaging unit (Pieces/Unit)	Dimensions (length x width x height)	Gross weight	Volume
4058075760752	Shipping box 1	568 mm x 140 mm x 430 mm	10078.00 g	34.20 dm <sup>3</sup>

The mentioned product code describes the smallest quantity unit which can be ordered. One shipping unit can contain one or more single products. When placing an order, for the quantity please enter single or multiples of a shipping unit.

**ADDITIONAL CATALOG INFORMATION**

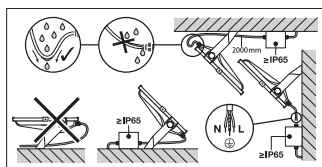
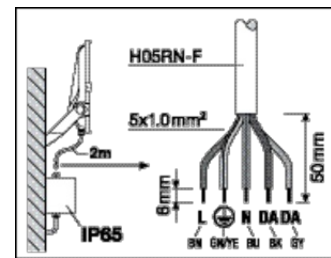
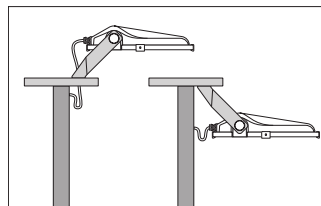
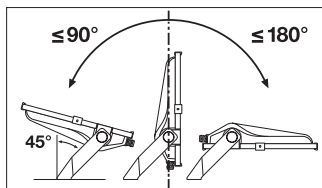

**References / Links**

– For Guarantee see [www.ledvance.com/guarantee](http://www.ledvance.com/guarantee)

**DISCLAIMER**

Subject to change without notice. Errors and omission excepted. Always make sure to use the most recent release.