

PRODUCT DATASHEET

DL UGR19 PFM DN155 14 W 840 WT IP54 DALI

DOWNLIGHT UGR19 DALI | Low-glare downlights, suitable for computer screen workstations with DALI-2 IoT technology



Areas of application

- Suitable for office applications, especially for computer screen workplaces
- Direct replacement for luminaires with compact fluorescent lamps
- Entrances / Hallways
- Bathrooms, kitchens and sheltered outdoor areas
- General illumination

Product benefits

- Suitable luminaire for VIVARES and other DALI-2 Light Management Systems
- Good glare reduction (UGR < 19) and cut off angle up to 30° for comfortable indoor lighting
- Easy and quick installation thanks to connector box with 5-pole toolless terminal
- Low flicker light
- Suitable for use in dusty and damp locations thanks to high IP rating
- 5 years guarantee

Product features

- IoT-ready luminaire with DALI-2 technology
- Housing material: Aluminum mirror-finished reflector
- Type of protection: IP54 (room side) / IP20 (back side)
- Connector box with push wire terminal for tool-free connection



- Through-wiring possible

TECHNICAL DATA

Electrical data

Nominal wattage	14.00 W
Nominal voltage	220...240 V
Mains frequency	0/50/60 Hz
Nominal current	154 mA
Inrush current	5 A
Inrush current time T_{h50}	200 μ s
Max. number of luminaires per miniature circuit breaker B16	120
Max. number of luminaires per miniature circuit breaker C10	80
Max. number of luminaires per miniature circuit breaker C16	120
Power factor λ	≥ 0.90
Total harmonic distortion	< 15 %
Protection class	II
Operating mode	External LED driver
Dimming interface	DALI-2 / IoT

Photometrical data

Luminous flux	1600 lm
Luminous efficacy	115 lm/W
Color temperature	4000 K
Light color (designation)	Cool White
Color rendering index Ra	≥ 80
Standard deviation of color matching	≤ 5 sdc _m
Luminous intensity	-
Low flicker	Yes
Flickering metric (Pst LM)	-
Stroboscope effect metric (SVM)	-
Photobiological safety group acc. to EN62778	RG1
Photobiological safety group acc. to EN62471	RG0
Beam angle	65 °
UGR	< 19

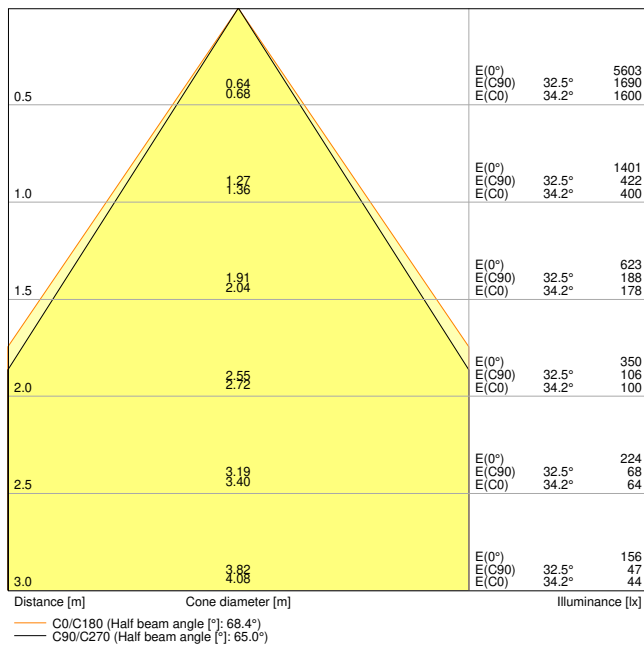

DL_UGR19_DN155_PFM_14W840_DALI_WT

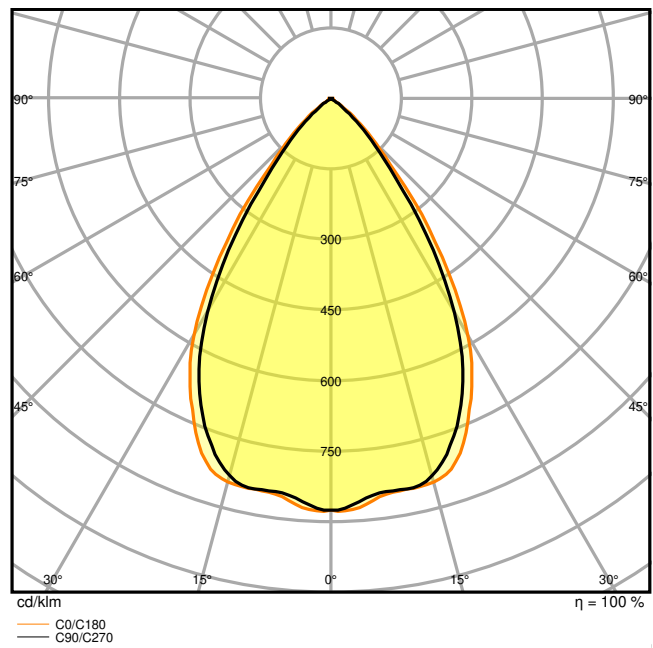

DL_UGR19_DN155_PFM_14W840_DALI_WT

Dimensions & Weight

Diameter	180.00 mm
Height	65.00 mm
Product weight	650.00 g

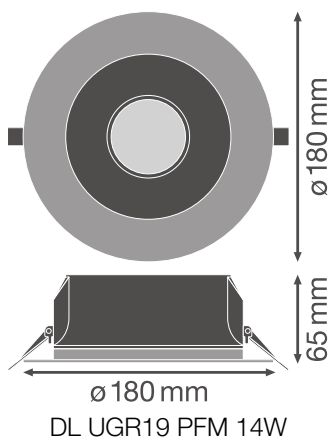

Materials & Colors

Product color	White
Housing color	White
Body material	Aluminum
Cover material	Polycarbonate (PC)
Light emitting surface material	Polycarbonate (PC)
Glow Wire Test according to IEC 60695-2-12	650 °C
Mercury content	0.0 mg

Application & Mounting

Ambient temperature range	-20...+45 °C
Temperature range at storage	-40...+70 °C
Type of connection	Screwless terminal, 5-Pole (L, N, PE, DA+, DA-)
Type of protection	IP54/IP20
Protection class IK (shock resistance)	IK03
Dimmable	Yes
Type of dimming	DALI
Mounting type	Recessed
Mounting location	Ceiling
Application environment	Indoor
Mounting diameter	155,0 mm
Mounting depth	100 mm
With light source	Yes

Lifespan

Lifespan L70/B50 at 25 °C	70000 h ¹⁾
Lifespan L80/B10 at 25 °C	60000 h ¹⁾
Lifespan L80/B50 at 25 °C	60000 h
Lifespan L90/B10 at 25 °C	40000 h
Number of switching cycles	100000

¹⁾ t[h]: L70 / B50 @ 25 °C (Ta), t[h]: L80 / B10 @ 25 °C (Ta), t[h]: L90 / B10 @ 25 °C (Ta)

Control gear

Output current	450 mA
ECG - Output ripple current	< 10 %
ECG - Length	119.0 mm
ECG - Width	52.0 mm

ECG - Height	30 mm
--------------	-------

Certificates & Standards

Standards	CE / CB / TÜV SÜD / EAC
Luminaire with limited surface temperature, "D sign"	No
Ball shot safe	No
Replaceable light source (EPREL)	Not replaceable







Additional product data



Number of illuminants	Not relevant
Added function	VIVARES











EQUIPMENT / ACCESSORIES

- External control gear included

DOWNLOAD DATA

Documents and certificates		Document name
	User instruction / safety instructions	DL UGR19 PFM
	Legal information	Legal insert DL UGR19 PFM
	Legal information	LSI DL UGR19 PFM
	Legal information	Informationstext 18 Abs 4 ElektroG
	Declarations of conformity	DL UGR19 DN155 PFM DALI WT
	Declarations of conformity UKCA	DL UGR19 PFM WT

Photometric and lighting design files		Document name
	IES file (IES)	DL UGR19 DN155 PFM 14W 840 DALI WT
	LDT file (Eulumdat)	DL UGR19 DN155 PFM 14W 840 DALI WT

Photometric and lighting design files		Document name
	ULD file (DIALux)	DL UGR19 DN155 PFM 14W-840 DALI WT
	ROLF file (RELUX)	DL UGR19 DALI DN155 14W 840 WT IP54
	UGR file (UGR table)	DL UGR19 DN155 PFM 14W840 DALI WT
	UGR file (UGR table)	DL UGR19 DN155 PFM 14W 840 DALI WT
	UGR file (UGR table)	DL_UGR19_DN155_PFM_14W840_DALI_WT
	Light distribution curve type cone	DL_UGR19_DN155_PFM_14W840_DALI_WT
	Light distribution curve type polar	DL_UGR19_DN155_PFM_14W840_DALI_WT
CAD/BIM files		Document name
	BIM Revit 3D	DL UGR19
	CAD STEP 3D	DL UGR19 14W
Tender texts		Document name
	Tender documents	DOWNLIGHT UGR19 DALI DN155 14 W 840 WT IP54 DALI-EN

LOGISTICAL DATA

Product code	Packaging unit (Pieces/Unit)	Dimensions (length x width x height)	Gross weight	Volume
4058075459311	Folding box 1	215 mm x 84 mm x 219 mm	850.00 g	3.96 dm ³
4058075459328	Shipping box 24	526 mm x 449 mm x 468 mm	21806.00 g	110.53 dm ³

The mentioned product code describes the smallest quantity unit which can be ordered. One shipping unit can contain one or more single products. When placing an order, for the quantity please enter single or multiples of a shipping unit.

ADDITIONAL CATALOG INFORMATION

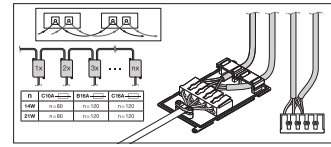
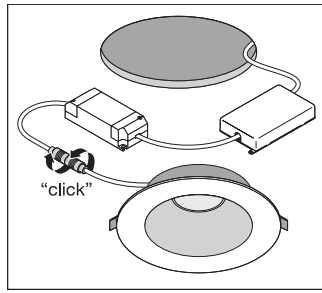
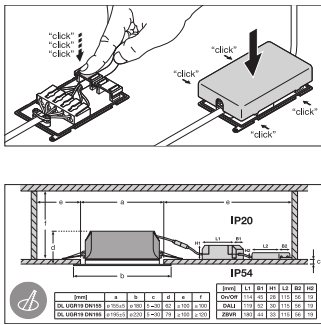

References / Links

– For Guarantee see www.ledvance.com/guarantee

DISCLAIMER

Subject to change without notice. Errors and omission excepted. Always make sure to use the most recent release.