

## Description



These switches are used on machines where the hazardous conditions remain for a while, even after the machines have been switched off, for example because of mechanical inertia of pulleys, saw disks, parts under pressure or with high temperatures. Thus, the switches can also be used if individual guards are only to be opened under certain conditions.

The versions with solenoid actuated NC contacts are considered interlocks with locking in accordance with ISO 14119, and the product's label is marked with the symbol shown.



### Holding force of the locked actuator

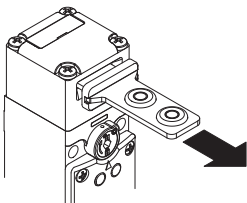

The strong interlocking system guarantees a maximum actuator holding force of  $F_{1max} = 3000 \text{ N}$ .

### Wide-ranging actuator travel

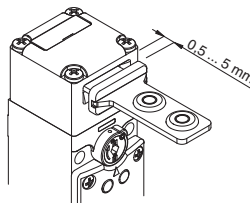

The actuation head of this switch features a wide range of travel. In this way the guard can oscillate along the direction of insertion (4.5 mm) without causing unwanted machine shutdowns. This wide range of travel is available in all actuators in order to ensure maximum device reliability.

### Heads and devices with variable orientation

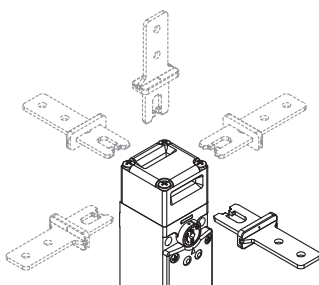

The system can be variably configured by loosening the 4 screws on the head.

The key release device and the release button can also be rotated and secured independently of one another in steps of  $90^\circ$ . The device can thus assume 32 different configurations.

### Contact blocks with 4 contacts



Innovative contact block with 4 contacts, available in various contact configurations for monitoring the actuator or the solenoid (patented). The unit is supplied with captive screws and self-lifting clamping plates. Removable finger protection for eyelet terminal. High-reliability electrical contacts with 4 contact points and double interruption.

### Turnable key release with lock

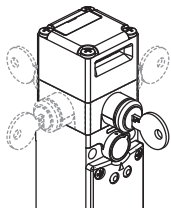

The auxiliary key release device is used to allow the maintenance or the entry into the machinery to authorized personnel only. Turning the key corresponds to actuating the solenoid: the actuator is released. The device can be turned, thereby enabling installation of the safety switch in the machine while the release device remains accessible on the outside of the guard.

### Safety screws for actuators

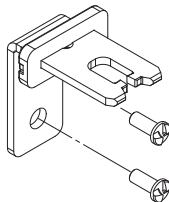

As required by EN ISO 14119, the actuator must be fixed immovably to the guard frame. Pan head safety screws with one-way fitting are available for this purpose. With this screw type, the actuators cannot be removed or tampered by using common tools. See accessories on page 419.

### Key release device and escape release button

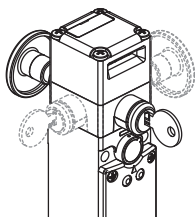

This device performs simultaneously the two functions mentioned above. The lock and button can be rotated in this case as well; the release button can be ordered with various lengths. The release button has priority over the lock, i.e., the emergency escape can be actuated to unlock the switch even if the lock is locked. To reset the switch, the lock and the button must be returned to their initial position.

### Escape release button

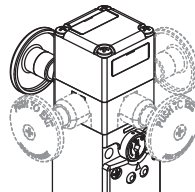

This device is used to safeguard a hazardous area that an operator may enter with his entire body. The release button, which is oriented towards the inside of the danger zone, allows the operator to escape even in the event of a power failure. Pushing the button results in the same function as the auxiliary release device. To reset the switch, simply return the button to its initial position. The escape release button can be rotated and is available with different lengths. It is fixed to the switch by means of a screw allowing the installation of the switch both inside and outside the guards.

### Key release with triangular key



The auxiliary key release is also available with option V73, a variant with triangular key acc. to DIN 22417. This option can be used with installations in which the auxiliary release is to be actuated with a triangular key that is not normally available.

On request, option V70 is also available, with which the auxiliary release returns to the initial position with the aid of a spring.

### Non-detachable heads and release devices

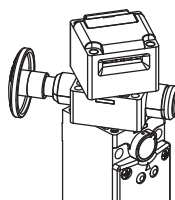

The head and the release device can be rotated but cannot be detached from each other. This makes the switch more secure since the problem of incorrect assembly by the installer cannot occur; in addition, the risk of damage is lower (loss of small parts, penetration of dirt, etc.).



### LED display unit, type A



In the version with LED display unit of type A, two green LEDs are switched-on directly by the power supply of the solenoid. Wiring is not necessary.

### LED display unit, types B and C



In the version with LED display unit of type B, connection wires from two LEDs are available, one green and one red. By means of suitable connections on the contact block, various operating states of the switch can be displayed externally.

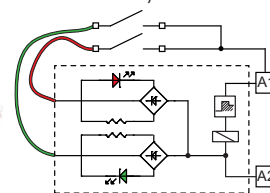

### Protection degree IP67

# IP67

These devices are designed to be used under the toughest environmental conditions, and they pass the IP67 immersion test acc. to EN 60529. They can therefore be used in all environments where the maximum degree of protection is required for the housing.

### Three conduit entries

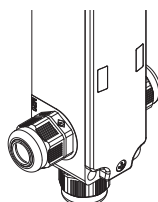

The switch is provided with three conduit entries in different directions. This allows its application in series connections or in narrow places.

### Extended temperature range

# -40°C

These devices are also available in a special version suitable for an ambient operating temperature range from -40°C up to +60°C.

They can therefore be used for applications in cold stores, sterilisers, and other equipment operated in very low-temperature environments. The special materials used to produce these versions retain their characteristics even under these conditions, thereby expanding the installation possibilities.

### Sealable auxiliary release device



Switches with locked actuator with deactivated solenoid (function principle D) are equipped with an auxiliary release device for the solenoid to simplify installation of the switch and to facilitate entry into the danger zone in the event of a power failure. The auxiliary release device acts on the switch exactly as if the solenoid was energised. As a result, it also actuates the electrical contacts. Can only be actuated with the use of two tools; this ensures adequate protection against tampering. If necessary, it can be sealed using the appropriate hole.

### Laser engraving



All FG series switches are permanently marked with a special laser system. As a result, the marking remains legible even under extreme operating conditions. Thanks to this system that does not use labels, the loss of plate data is prevented and a greater resistance of the marking is achieved over time.

### Access monitoring

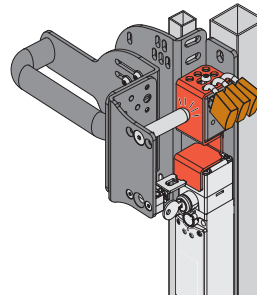

These safety switches alone do not provide sufficient personal protection to the operators or maintenance personnel in situations where they completely enter the danger zone, since unintentional closing of a door after entry could cause the machine to re-start. If the re-start release is completely dependent on these switches, a system for preventing this danger must be provided, e.g. a padlockable device for actuator entry locking VF KB2 (page 137) or a safety handle, such as a P-KUBE 1 (page 209).

### Holding force of the unlocked actuator

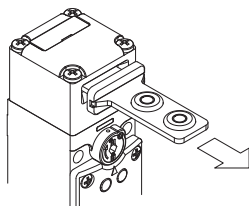

The inside of each switch features a device which holds the actuator in its closed position. Ideal for all those applications where several guards are unlocked simultaneously, but only one is actually opened. The device keeps all the unlocked guards in their position with a retaining force of approx. 30 N, stopping any vibrations or gusts of wind from opening them.

### LED signalling lights



Thanks to the three threaded cable entries, the high luminosity LED signalling lights of the VF SL series can be installed on the switch.

The LED signalling lights can be easily installed by screwing them on one of the conduit entries not used for electric cables. They can be used for many different purposes: for example, to signal, from a distance, whether the switch has been actuated; whether the guard has closed correctly; or whether the guard is locked or unlocked.

For more information see chapter Accessories, page 419.

Selection diagram

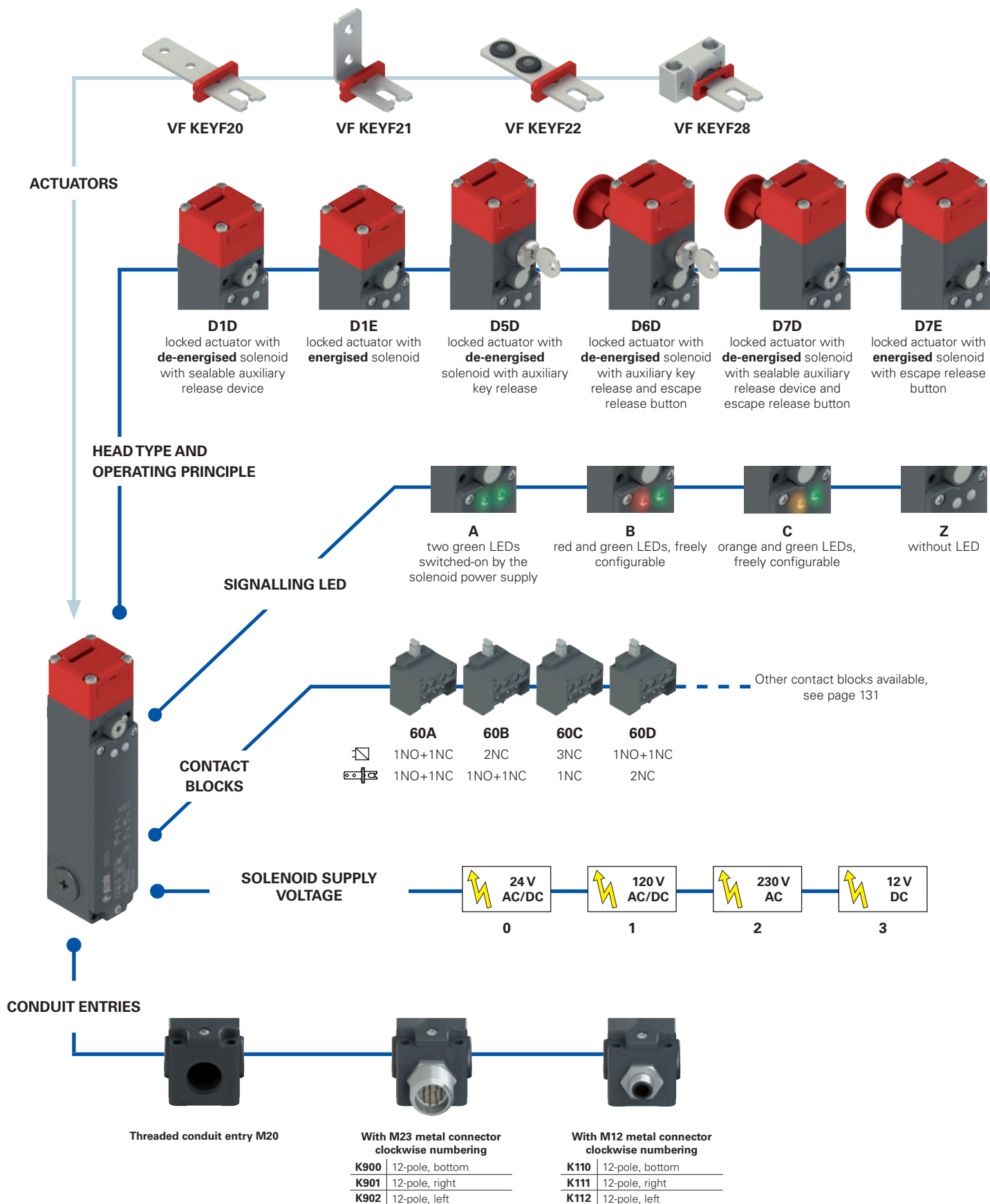

● product option  
 → Sold separately as accessory



## Code structure

**Attention!** The feasibility of a code number does not mean the effective availability of a product. Please contact our sales office.

article options

# FG 60AD1D0A-LP30F20GK900T6V34

## Contact blocks

	Contacts activated by the solenoid	Contacts activated by the actuator
<b>60A</b>	1NO+1NC	1NO+1NC
<b>60B</b>	2NC	1NO+1NC
<b>60C</b>	3NC	1NC
<b>60D</b>	1NO+1NC	2NC
<b>60E</b>	1NO+2NC	1NC
<b>60F</b>	1NO+2NC	1NO
<b>60G</b>	2NC	2NC
<b>60H</b>	4NC	/
<b>60I</b>	3NC	1NO
<b>60L</b>	2NO+1NC	1NC
<b>60M</b>	2NO+1NC	1NO
<b>60N</b>	1NO+1NC	2NO
<b>60P</b>	1NC	3NC
<b>60R</b>	2NO+2NC	/
<b>60S</b>	1NC	2NO+1NC
<b>60T</b>	1NC	1NO+2NC
<b>60U</b>	/	4NC
<b>60V</b>	2NC	2NO
<b>60X</b>	1NO	3NC
<b>60Y</b>	1NO	1NO+2NC
<b>61A</b>	/	1NO+3NC
<b>61B</b>	/	2NO+2NC
<b>61C</b>	/	3NO+1NC
<b>61D</b>	1NC	3NO
<b>61E</b>	1NO	2NO+1NC
<b>61G</b>	2NO	1NO+1NC
<b>61H</b>	2NO	2NC
<b>61M</b>	3NO	1NC
<b>61R</b>	1NO+3NC	/
<b>61S</b>	3NO+1NC	/

**Note:** contact blocks 60U, 61A, 61B, 61C cannot be combined with operating principles D6D, D7D, D7E.

## Operating principle

<b>D1D</b>	locked actuator with de-energised solenoid. With sealable auxiliary release device.
<b>D1E</b>	locked actuator with energised solenoid
<b>D5D</b>	locked actuator with de-energised solenoid. With auxiliary key release.
<b>D6D</b>	locked actuator with de-energised solenoid. With auxiliary key release and escape release button.
<b>D7D</b>	locked actuator with de-energised solenoid. With sealable auxiliary release device and escape release button.
<b>D7E</b>	locked actuator with energised solenoid. With escape release button

## Auxiliary release options

(only for articles FG **D5D**, FG **D6D**)

	The key can be removed in locked and unlocked actuator position (standard)
<b>V34</b>	The key can be removed only in the locked position of the actuator
<b>V70</b>	Key release with triangular key with spring return
<b>V73</b>	Key release with triangular key, no spring return

## Ambient temperature

-25°C ... +60°C (standard)

**T6** -40°C ... +60°C

## Pre-installed connectors

without connector (standard)

**K900** M23 metal connector, 12-pole, bottom

...

**K110** M12 metal connector, 12-pole, bottom

...

For the complete list of possible combinations please contact our technical department.

## Contact type

silver contacts (standard)

**G** silver contacts with 1 µm gold coating

## Actuators

without actuator (standard)

**F20** straight actuator VF KEYF20**F21** angled actuator VF KEYF21**F22** actuator with rubber pads VF KEYF22**F28** universal actuator VF KEYF28

## Release button length

for max. 15 mm wall thickness (standard)

**LP30** for max. 30 mm wall thickness**LP40** for max. 40 mm wall thickness**LP60** for max. 60 mm wall thickness**LPRG** adjustable, for wall thickness from 60 mm to 500 mm

## Signalling LEDs

**A** two green LEDs switched-on by the solenoid power supply**B** red and green LEDs, freely configurable**C** orange and green LEDs, freely configurable**Z** without LED

## Solenoid supply voltage

**0** 24 Vac/dc (-10% ... +10%)**1** 120 Vac/dc (-15% ... +10%)**2** 230 Vac (-15% ... +10%)**3** 12 Vdc (-10% ... +10%)

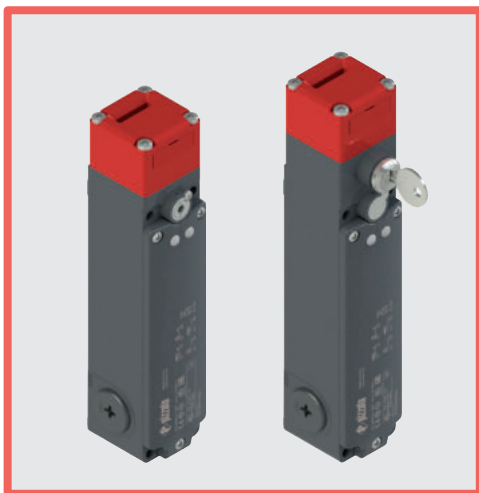

### Main features

- Actuator holding force  $F_{1max}$ : 3000 N
- 30 contact blocks with 4 contacts
- Metal housing, three M20 conduit entries
- Protection degree IP67
- Versions with key release and escape release button
- 4 stainless steel actuators
- Head and release devices, individually turnable and non-detachable
- Signalling LEDs
- Operation with energised or de-energised solenoid

### Quality marks:



IMQ approval:	CA02.03808
UL approval:	E131787
CCC approval:	2021000305000103
EAC approval:	RU C-IT.YT03.B.00035/19

### Technical data

#### Housing

Metal head and housing, baked powder coating.	M20x1.5 (standard)
Three threaded conduit entries:	IP67 acc. to EN 60529 with cable gland of equal or higher protection degree
Protection degree:	

#### General data

SIL (SIL CL) up to:	SIL 3 acc. to EN 62061
Performance Level (PL) up to:	PL e acc. to EN ISO 13849-1
Interlock with mechanical lock, coded:	type 2 acc. to EN ISO 14119
Coding level:	low acc. to EN ISO 14119
Safety parameters:	
$B_{10D}$ :	5,000,000 for NC contacts
Mission time:	20 years
Ambient temperature:	-25°C ... +60°C (standard) -40°C ... +60°C (T6 option)
Max. actuation frequency:	600 operating cycles/hour
Mechanical endurance:	1 million operating cycles
Max. actuation speed:	0.5 m/s
Min. actuation speed:	1 mm/s
Maximum force before breakage $F_{1max}$ :	3000 N acc. to EN ISO 14119
Max. holding force $F_{Zh}$ :	2300 N acc. to EN ISO 14119
Maximum clearance of locked actuator:	4.5 mm
Released actuator extraction force:	30 N
Tightening torques for installation:	see page 441
Wire cross-sections and wire stripping lengths:	see page 465

#### Solenoid

Duty cycle:	100% ED (continuous operation)
Solenoid consumption:	9 VA

#### In compliance with standards:

IEC 60947-5-1, IEC 60947-1, IEC 60204-1, EN ISO 14119, EN ISO 12100, IEC 60529, IEC 61000-6-2, IEC 61000-6-3, EN IEC 63000, BG-GS-ET-15, BG-GS-ET-19, UL 508, CSA C22.2 No. 14.

#### Approvals:

EN 60947-5-1, UL 508, CSA C22.2 No. 14, GB/T14048.5

#### Compliance with the requirements of:

Machinery Directive 2006/42/EC, EMC Directive 2014/30/EU, RoHS Directive 2011/65/EU.

#### Positive contact opening in conformity with standards:

IEC 60947-5-1, EN 60947-5-1.

**⚠ If not expressly indicated in this chapter, for correct installation and utilization of all articles see the instructions given on pages 443 to 454.**

### Electrical data

### Utilization category

without connector	with M23 connector, 12-pole	with M12 connector, 12-pole	
Thermal current ( $I_{th}$ ):	10 A	8 A	1.5 A
Rated insulation voltage (U):	400 Vac 300 Vdc	250 Vac 300 Vdc	30 Vac 36 Vdc
Rated impulse withstand voltage ( $U_{imp}$ ):	6 kV	6 kV	6 kV
Conditional short circuit current:	1000 A acc. to EN 60947-5-1	1000 A acc. to EN 60947-5-1	1000 A acc. to EN 60947-5-1
Protection against short circuits:	type gG fuse 10 A 500 V	type gG fuse 8 A 500 V	type gG fuse 1.5 A
Pollution degree:	3	3	3
Utilization category			Alternating current: AC15 (50÷60 Hz)
U <sub>e</sub> (V)			120 250 400
I <sub>e</sub> (A)			6 5 3
Direct current: DC13			
U <sub>e</sub> (V)			24 125 250
I <sub>e</sub> (A)			3 0.7 0.4
Utilization category			Alternating current: AC15 (50÷60 Hz)
U <sub>e</sub> (V)			120 250
I <sub>e</sub> (A)			6 5
Direct current: DC13			
U <sub>e</sub> (V)			24 125 250
I <sub>e</sub> (A)			3 0.7 0.4
Utilization category			Alternating current: AC15 (50÷60 Hz)
U <sub>e</sub> (V)			24
I <sub>e</sub> (A)			1.5
Direct current: DC13			
U <sub>e</sub> (V)			24
I <sub>e</sub> (A)			1.5



### Features approved by IMQ

Rated insulation voltage (U<sub>i</sub>): 400 Vac  
 Conventional free air thermal current (I<sub>th</sub>): 10 A  
 Protection against short circuits: type gG fuse 10 A 500 V  
 Rated impulse withstand voltage (U<sub>imp</sub>): 6 kV  
 Protection degree of the housing: IP67  
 MV terminals (screw terminals)  
 Pollution degree: 3  
 Utilization category: AC15  
 Operating voltage (U<sub>e</sub>): 400 Vac (50 Hz)  
 Operating current (I<sub>e</sub>): 3 A

Forms of the contact element: X+X+X+X, Y+Y+Y+Y, X+Y+Y+Y, X+X+Y+Y, X+X+X+Y  
 Positive opening of contacts on all contact blocks: 60A, 60B, 60C, 60D, 60E, 60F, 60G, 60H, 60I, 60L, 60M, 60N, 60P, 60R, 60S, 60T, 60U, 60V, 60X, 60Y, 61A, 61B, 61C, 61D, 61E, 61G, 61H, 61M, 61R, 61S

In compliance with standards: EN 60947-1, EN 60947-5-1, fundamental requirements of the Low Voltage Directive 2014/35/EU.

Please contact our technical department for the list of approved products.

### Features approved by UL



Electrical Ratings: A300 pilot duty (720 VA, 120-300 Vac)  
 Q300 pilot duty (69 VA, 125-250 Vdc)  
 Environmental Ratings: Types 1, 4X, 12, 13

Please contact our technical department for the list of approved products.

### Operating principle

The operating principle of these safety switches allows three different operating states:

- state A**: with inserted and locked actuator
- state B**: with inserted but not locked actuator
- state C**: with extracted actuator

All or some of these states can be monitored by means of electrical NO contacts or NC contacts with positive opening by selecting the appropriate contact blocks. In detail, contact blocks that have electric contacts marked with the symbol of the solenoid (  ) are switched in the transition between the state A and state B, while the electric contacts marked with the symbol of the actuator (  ) are switched between state B and state C.

#### Operating principle

Select from two operating principles for actuator locking:

- Operating principle D**: locked actuator with de-energised solenoid. The actuator is released by applying the power supply to the solenoid (see example of the operating phases).
- Operating principle E**: locked actuator with energised solenoid. The actuator is released by switching off the power supply to the solenoid. This version should only be used under certain conditions, since a power failure at the system will result in the immediate opening of the guard.

### Example: operating phases with FG 60AD1D0A-F21 (switch with operating principle D)

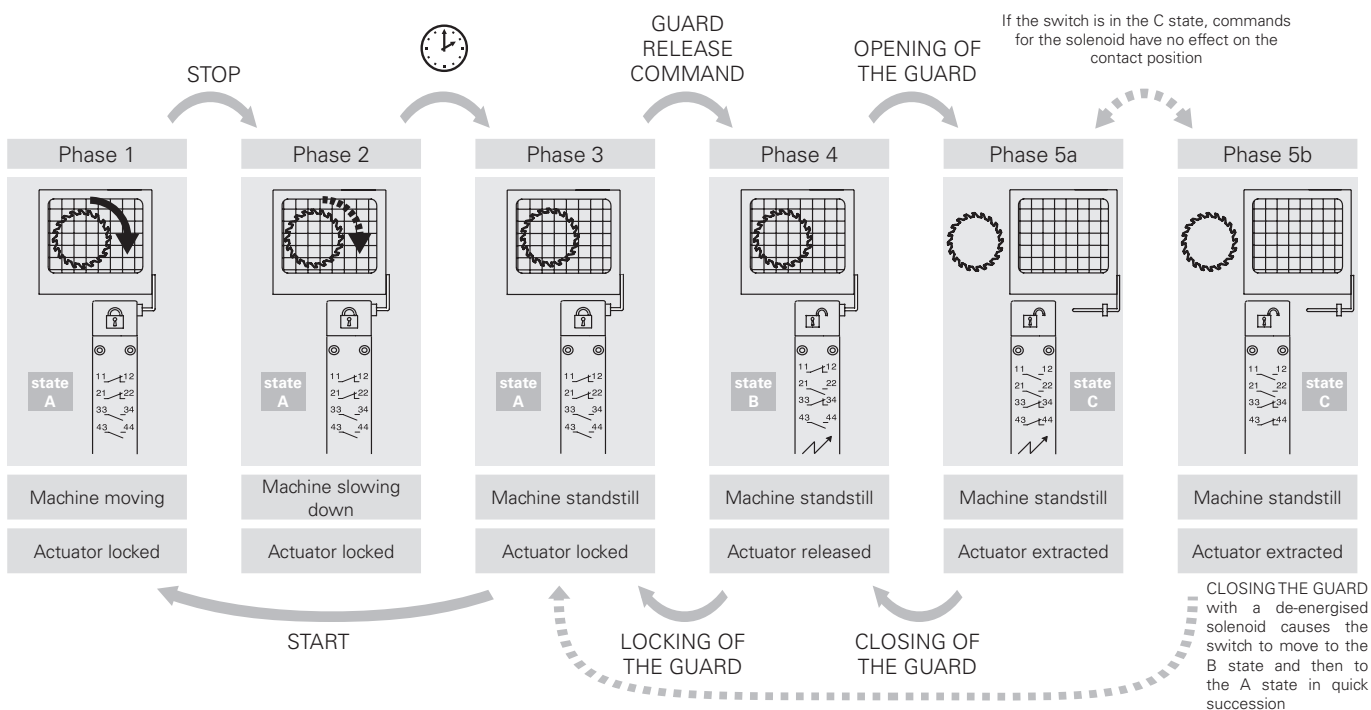

Contact positions related to switch states

Operating state	Operating principle D locked actuator with de-energised solenoid			Operating principle E locked actuator with energised solenoid		
	state A	state B	state C	state A	state B	state C
	Inserted and locked De-energised	Inserted and released Energised	Extracted -	Inserted and locked Energised	Inserted and released De-energised	Extracted -
<b>FG 60A</b> ..... 1NO+1NC controlled by the solenoid 1NO+1NC controlled by the actuator						
<b>FG 60B</b> ..... 2NC controlled by the solenoid 1NO+1NC controlled by the actuator						
<b>FG 60C</b> ..... 3NC controlled by the solenoid 1NC controlled by the actuator						
<b>FG 60D</b> ..... 1NO+1NC controlled by the solenoid 2NC controlled by the actuator						
<b>FG 60E</b> ..... 1NO+2NC controlled by the solenoid 1NC controlled by the actuator						
<b>FG 60F</b> ..... 1NO+2NC controlled by the solenoid 1NO controlled by the actuator						
<b>FG 60G</b> ..... 2NC controlled by the solenoid 2NC controlled by the actuator						
<b>FG 60H</b> ..... 4NC controlled by the solenoid						
<b>FG 60J</b> ..... 3NC controlled by the solenoid 1NO controlled by the actuator						
<b>FG 60L</b> ..... 2NO+1NC controlled by the solenoid 1NC controlled by the actuator						
<b>FG 60M</b> ..... 2NO+1NC controlled by the solenoid 1NO controlled by the actuator						
<b>FG 60N</b> ..... 1NO+1NC controlled by the solenoid 2NO controlled by the actuator						
<b>FG 60P</b> ..... 1NC controlled by the solenoid 3NC controlled by the actuator						
<b>FG 60R</b> ..... 2NO+2NC controlled by the solenoid						
<b>FG 60S</b> ..... 1NC controlled by the solenoid 2NO+1NC controlled by the actuator						









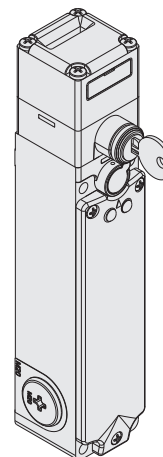
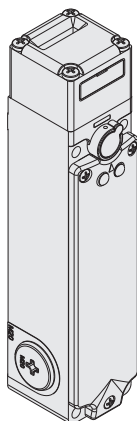
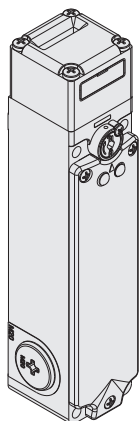





















































































































































































Operating state	Operating principle D locked actuator with de-energised solenoid			Operating principle E locked actuator with energised solenoid		
	state A	state B	state C	state A	state B	state C
	Inserted and locked De-energised	Inserted and released Energised	Extracted -	Inserted and locked Energised	Inserted and released De-energised	Extracted -
Actuator						
Solenoid						
FG 60T..... 1NC controlled by the solenoid 1NO+2NC controlled by the actuator	11  12 21  22 31  32 43  44	11  12 21  22 31  32 43  44	11  12 21  22 31  32 43  44	11  12 21  22 31  32 43  44	11  12 21  22 31  32 43  44	11  12 21  22 31  32 43  44
FG 60U..... 4NC controlled by the actuator	11  12 21  22 31  32 41  42	11  12 21  22 31  32 41  42	11  12 21  22 31  32 41  42	11  12 21  22 31  32 41  42	11  12 21  22 31  32 41  42	11  12 21  22 31  32 41  42
FG 60V..... 2NC controlled by the solenoid 2NO controlled by the actuator	11  12 21  22 33  34 43  44	11  12 21  22 33  34 43  44	11  12 21  22 33  34 43  44	11  12 21  22 33  34 43  44	11  12 21  22 33  34 43  44	11  12 21  22 33  34 43  44
FG 60X..... 1NO controlled by the solenoid 3NC controlled by the actuator	13  14 21  22 31  32 41  42	13  14 21  22 31  32 41  42	13  14 21  22 31  32 41  42	13  14 21  22 31  32 41  42	13  14 21  22 31  32 41  42	13  14 21  22 31  32 41  42
FG 60Y..... 1NO controlled by the solenoid 1NO+2NC controlled by the actuator	11  12 21  22 33  34 43  44	11  12 21  22 33  34 43  44	11  12 21  22 33  34 43  44	11  12 21  22 33  34 43  44	11  12 21  22 33  34 43  44	11  12 21  22 33  34 43  44
FG 61A..... 1NO+3NC controlled by the actuator	11  12 21  22 31  32 43  44	11  12 21  22 31  32 43  44	11  12 21  22 31  32 43  44	11  12 21  22 31  32 43  44	11  12 21  22 31  32 43  44	11  12 21  22 31  32 43  44
FG 61B..... 2NO+2NC controlled by the actuator	11  12 21  22 33  34 43  44	11  12 21  22 33  34 43  44	11  12 21  22 33  34 43  44	11  12 21  22 33  34 43  44	11  12 21  22 33  34 43  44	11  12 21  22 33  34 43  44
FG 61C..... 3NO+1NC controlled by the actuator	13  14 21  22 33  34 43  44	13  14 21  22 33  34 43  44	13  14 21  22 33  34 43  44	13  14 21  22 33  34 43  44	13  14 21  22 33  34 43  44	13  14 21  22 33  34 43  44
FG 61D..... 1NC controlled by the solenoid 3NO controlled by the actuator	13  14 21  22 33  34 43  44	13  14 21  22 33  34 43  44	13  14 21  22 33  34 43  44	13  14 21  22 33  34 43  44	13  14 21  22 33  34 43  44	13  14 21  22 33  34 43  44
FG 61E..... 1NO controlled by the solenoid 2NO+1NC controlled by the actuator	13  14 21  22 33  34 43  44	13  14 21  22 33  34 43  44	13  14 21  22 33  34 43  44	13  14 21  22 33  34 43  44	13  14 21  22 33  34 43  44	13  14 21  22 33  34 43  44
FG 61G..... 2NO controlled by the solenoid 1NO+1NC controlled by the actuator	13  14 21  22 33  34 43  44	13  14 21  22 33  34 43  44	13  14 21  22 33  34 43  44	13  14 21  22 33  34 43  44	13  14 21  22 33  34 43  44	13  14 21  22 33  34 43  44
FG 61H..... 2NO controlled by the solenoid 2NC controlled by the actuator	11  12 21  22 33  34 43  44	11  12 21  22 33  34 43  44	11  12 21  22 33  34 43  44	11  12 21  22 33  34 43  44	11  12 21  22 33  34 43  44	11  12 21  22 33  34 43  44
FG 61M..... 3NO controlled by the solenoid 1NC controlled by the actuator	13  14 21  22 33  34 43  44	13  14 21  22 33  34 43  44	13  14 21  22 33  34 43  44	13  14 21  22 33  34 43  44	13  14 21  22 33  34 43  44	13  14 21  22 33  34 43  44
FG 61R..... 1NO+3NC controlled by the solenoid	11  12 21  22 31  32 43  44	11  12 21  22 31  32 43  44	11  12 21  22 31  32 43  44	11  12 21  22 31  32 43  44	11  12 21  22 31  32 43  44	11  12 21  22 31  32 43  44
FG 61S..... 3NO+1NC controlled by the solenoid	13  14 21  22 33  34 43  44	13  14 21  22 33  34 43  44	13  14 21  22 33  34 43  44	13  14 21  22 33  34 43  44	13  14 21  22 33  34 43  44	13  14 21  22 33  34 43  44





Contact type  
 = slow action



Operating principle	Operating principle D, with sealable auxiliary release device, without actuator	Operating principle E, without actuator	Operating principle D, with key release, without actuator
Contact block	 	 	 
60A 	FG 60AD1D0A   1NO+1NC 1NO+1NC	FG 60AD1E0A   1NO+1NC 1NO+1NC	FG 60AD5D0A   1NO+1NC 1NO+1NC
60B 	FG 60BD1D0A   2NC 1NO+1NC	FG 60BD1E0A   2NC 1NO+1NC	FG 60BD5D0A   2NC 1NO+1NC
60C 	FG 60CD1D0A   3NC 1NC	FG 60CD1E0A   3NC 1NC	FG 60CD5D0A   3NC 1NC
60D 	FG 60DD1D0A   1NO+1NC 2NC	FG 60DD1E0A   1NO+1NC 2NC	FG 60DD5D0A   1NO+1NC 2NC
60E 	FG 60ED1D0A   1NO+2NC 1NC	FG 60ED1E0A   1NO+2NC 1NC	FG 60ED5D0A   1NO+2NC 1NC
60F 	FG 60FD1D0A   1NO+2NC 1NO	FG 60FD1E0A   1NO+2NC 1NO	FG 60FD5D0A   1NO+2NC 1NO
60G 	FG 60GD1D0A   2NC 2NC	FG 60GD1E0A   2NC 2NC	FG 60GD5D0A   2NC 2NC
60H 	FG 60HD1D0A   4NC /	FG 60HD1E0A   4NC /	FG 60HD5D0A   4NC /
60I 	FG 60ID1D0A   3NC 1NO	FG 60ID1E0A   3NC 1NO	FG 60ID5D0A   3NC 1NO
60L 	FG 60LD1D0A   2NO+1NC 1NC	FG 60LD1E0A   2NO+1NC 1NC	FG 60LD5D0A   2NO+1NC 1NC
60M 	FG 60MD1D0A   2NO+1NC 1NO	FG 60MD1E0A   2NO+1NC 1NO	FG 60MD5D0A   2NO+1NC 1NO
60N 	FG 60ND1D0A   1NO+1NC 2NO	FG 60ND1E0A   1NO+1NC 2NO	FG 60ND5D0A   1NO+1NC 2NO
60P 	FG 60PD1D0A   1NC 3NC	FG 60PD1E0A   1NC 3NC	FG 60PD5D0A   1NC 3NC
60R 	FG 60RD1D0A   2NO+2NC /	FG 60RD1E0A   2NO+2NC /	FG 60RD5D0A   2NO+2NC /
60S 	FG 60SD1D0A   1NC 2NO+1NC	FG 60SD1E0A   1NC 2NO+1NC	FG 60SD5D0A   1NC 2NO+1NC
60T 	FG 60TD1D0A   1NC 1NO+2NC	FG 60TD1E0A   1NC 1NO+2NC	FG 60TD5D0A   1NC 1NO+2NC
60U 	FG 60UD1D0A  / 4NC	FG 60UD1E0A  / 4NC	FG 60UD5D0A  / 4NC
60V 	FG 60VD1D0A   2NC 2NO	FG 60VD1E0A   2NC 2NO	FG 60VD5D0A   2NC 2NO
60X 	FG 60XD1D0A  1NO 3NC	FG 60XD1E0A  1NO 3NC	FG 60XD5D0A  1NO 3NC
60Y 	FG 60YD1D0A  1NO 1NO+2NC	FG 60YD1E0A  1NO 1NO+2NC	FG 60YD5D0A  1NO 1NO+2NC
61A 	FG 61AD1D0A  / 1NO+3NC	FG 61AD1E0A  / 1NO+3NC	FG 61AD5D0A  / 1NO+3NC
61B 	FG 61BD1D0A  / 2NO+2NC	FG 61BD1E0A  / 2NO+2NC	FG 61BD5D0A  / 2NO+2NC
61C 	FG 61CD1D0A  / 3NO+1NC	FG 61CD1E0A  / 3NO+1NC	FG 61CD5D0A  / 3NO+1NC
61D 	FG 61DD1D0A   1NC 3NO	FG 61DD1E0A   1NC 3NO	FG 61DD5D0A   1NC 3NO
61E 	FG 61ED1D0A  1NO 2NO+1NC	FG 61ED1E0A  1NO 2NO+1NC	FG 61ED5D0A  1NO 2NO+1NC
61G 	FG 61GD1D0A  2NO 1NO+1NC	FG 61GD1E0A  2NO 1NO+1NC	FG 61GD5D0A  2NO 1NO+1NC
61H 	FG 61HD1D0A  2NO 2NC	FG 61HD1E0A  2NO 2NC	FG 61HD5D0A  2NO 2NC
61M 	FG 61MD1D0A  3NO 1NC	FG 61MD1E0A  3NO 1NC	FG 61MD5D0A  3NO 1NC
61R 	FG 61RD1D0A   1NO+3NC /	FG 61RD1E0A   1NO+3NC /	FG 61RD5D0A   1NO+3NC /
61S 	FG 61SD1D0A   3NO+1NC /	FG 61SD1E0A   3NO+1NC /	FG 61SD5D0A   3NO+1NC /
Actuating force	30 N (60 N  )		
Travel diagrams	Page 464		









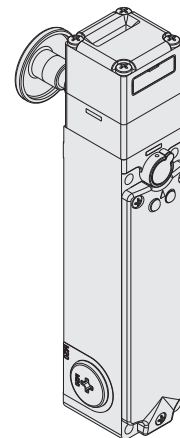
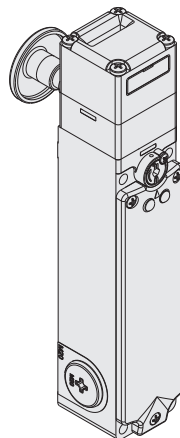
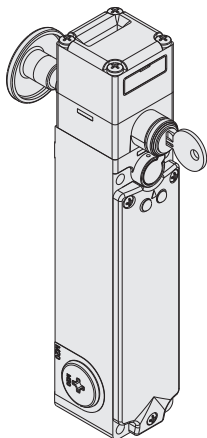

























































































































































Legend:  With positive opening according to EN 60947-5-1,  interlock with lock monitoring acc. to EN ISO 14119



 Contacts activated by the actuator  
 Contacts activated by the solenoid





Contact type  
[L] = slow action



Operating principle	Operating principle D, with key release, escape release button, without actuator	Operating principle D, with escape release button, without actuator	Operating principle E, with escape release button, without actuator
Contact block	 	 	 
60A [L]	FG 60AD6D0A   1NO+1NC 1NO+1NC	FG 60AD7D0A   1NO+1NC 1NO+1NC	FG 60AD7E0A   1NO+1NC 1NO+1NC
60B [L]	FG 60BD6D0A   2NC 1NO+1NC	FG 60BD7D0A   2NC 1NO+1NC	FG 60BD7E0A   2NC 1NO+1NC
60C [L]	FG 60CD6D0A   3NC 1NC	FG 60CD7D0A   3NC 1NC	FG 60CD7E0A   3NC 1NC
60D [L]	FG 60DD6D0A   1NO+1NC 2NC	FG 60DD7D0A   1NO+1NC 2NC	FG 60DD7E0A   1NO+1NC 2NC
60E [L]	FG 60ED6D0A   1NO+2NC 1NC	FG 60ED7D0A   1NO+2NC 1NC	FG 60ED7E0A   1NO+2NC 1NC
60F [L]	FG 60FD6D0A   1NO+2NC 1NO	FG 60FD7D0A   1NO+2NC 1NO	FG 60FD7E0A   1NO+2NC 1NO
60G [L]	FG 60GD6D0A   2NC 2NC	FG 60GD7D0A   2NC 2NC	FG 60GD7E0A   2NC 2NC
60H [L]	FG 60HD6D0A   4NC /	FG 60HD7D0A   4NC /	FG 60HD7E0A   4NC /
60I [L]	FG 60ID6D0A   3NC 1NO	FG 60ID7D0A   3NC 1NO	FG 60ID7E0A   3NC 1NO
60L [L]	FG 60LD6D0A   2NO+1NC 1NC	FG 60LD7D0A   2NO+1NC 1NC	FG 60LD7E0A   2NO+1NC 1NC
60M [L]	FG 60MD6D0A   2NO+1NC 1NO	FG 60MD7D0A   2NO+1NC 1NO	FG 60MD7E0A   2NO+1NC 1NO
60N [L]	FG 60ND6D0A   1NO+1NC 2NO	FG 60ND7D0A   1NO+1NC 2NO	FG 60ND7E0A   1NO+1NC 2NO
60P [L]	FG 60PD6D0A   1NC 3NC	FG 60PD7D0A   1NC 3NC	FG 60PD7E0A   1NC 3NC
60R [L]	FG 60RD6D0A   2NO+2NC /	FG 60RD7D0A   2NO+2NC /	FG 60RD7E0A   2NO+2NC /
60S [L]	FG 60SD6D0A   1NC 2NO+1NC	FG 60SD7D0A   1NC 2NO+1NC	FG 60SD7E0A   1NC 2NO+1NC
60T [L]	FG 60TD6D0A   1NC 1NO+2NC	FG 60TD7D0A   1NC 1NO+2NC	FG 60TD7E0A   1NC 1NO+2NC
60V [L]	FG 60VD6D0A   2NC 2NO	FG 60VD7D0A   2NC 2NO	FG 60VD7E0A   2NC 2NO
60X [L]	FG 60XD6D0A   1NO 3NC	FG 60XD7D0A   1NO 3NC	FG 60XD7E0A   1NO 3NC
60Y [L]	FG 60YD6D0A   1NO 1NO+2NC	FG 60YD7D0A   1NO 1NO+2NC	FG 60YD7E0A   1NO 1NO+2NC
61D [L]	FG 61DD6D0A   1NC 3NO	FG 61DD7D0A   1NC 3NO	FG 61DD7E0A   1NC 3NO
61E [L]	FG 61ED6D0A   1NO 2NO+1NC	FG 61ED7D0A   1NO 2NO+1NC	FG 61ED7E0A   1NO 2NO+1NC
61G [L]	FG 61GD6D0A   2NO 1NO+1NC	FG 61GD7D0A   2NO 1NO+1NC	FG 61GD7E0A   2NO 1NO+1NC
61H [L]	FG 61HD6D0A   2NO 2NC	FG 61HD7D0A   2NO 2NC	FG 61HD7E0A   2NO 2NC
61M [L]	FG 61MD6D0A   3NO 1NC	FG 61MD7D0A   3NO 1NC	FG 61MD7E0A   3NO 1NC
61R [L]	FG 61RD6D0A   1NO+3NC /	FG 61RD7D0A   1NO+3NC /	FG 61RD7E0A   1NO+3NC /
61S [L]	FG 61SD6D0A   3NO+1NC /	FG 61SD7D0A   3NO+1NC /	FG 61SD7E0A   3NO+1NC /
Actuating force	30 N (60 N  )		
Travel diagrams	Page 464		

Legend:  With positive opening according to EN 60947-5-1,  interlock with lock monitoring acc. to EN ISO 14119

 Contacts activated by the actuator

 Contacts activated by the solenoid

### Stainless steel actuators

**IMPORTANT:** These actuators can be used only with items of the FG and FY series (e.g. FG 60AD1D0A-F20).  
Low level of coding acc. to EN ISO 14119.

	Article	Description
	VF KEYF20	Straight actuator

	Article	Description
	VF KEYF21	Angled actuator

	Article	Description
	VF KEYF22	Actuator with rubber pads

### Universal actuator VF KEYF28

**IMPORTANT:** These actuators can be used only with items of the FG and FY series (e.g. FG 60AD1D0A-F28).  
Low level of coding acc. to EN ISO 14119.

	Article	Description
	VF KEYF28	Universal actuator

Jointed actuator for guards with poor alignment, adjustable in two dimensions for small doors; can be mounted in various positions. The metal fixing body has two pairs of bore holes; it is provided for rotating the working plane of the actuator by 90°.

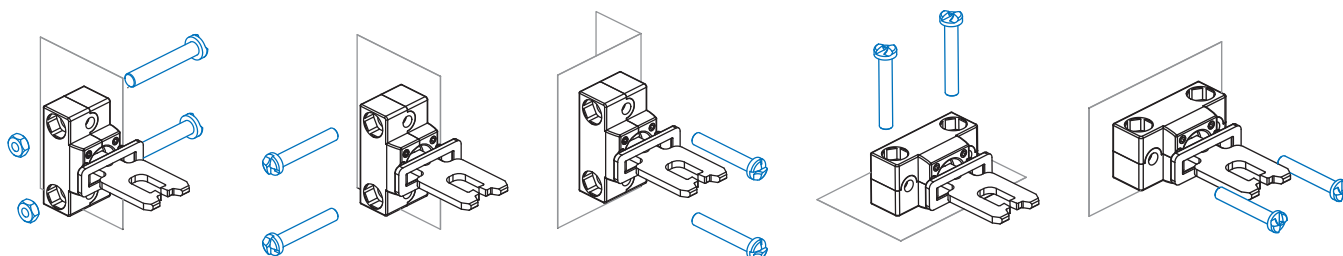
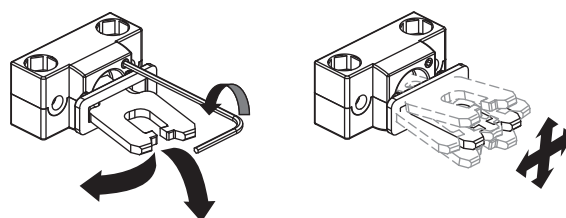
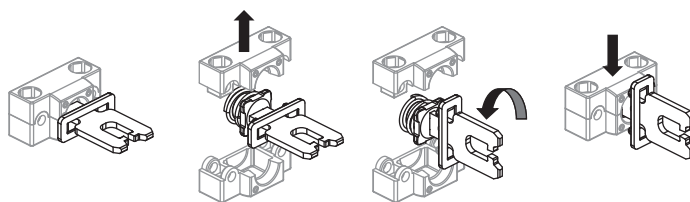

### Auxiliary key release with triangular key



Articles with the V70 and V73 option have an auxiliary key release with a triangular key that meets DIN 22417 standards. This type of lock can be used in situations where the switch must only be unlocked using the corresponding triangular key, a tool which is not usually available. There are two versions of the triangular key release: with a spring return (option V70) and without a spring return (option V73).

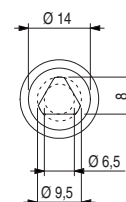



## Wiring diagram for M12 connectors

## M12 connector, 12-pole

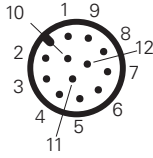

Contact block 60A 2NO+2NC		Contact block 60B 1NO+3NC		Contact block 60C 4NC		Contact block 60D 1NO+3NC		Contact block 60E 1NO+3NC		Contact block 60F 2NO+2NC		Contact block 60G 4NC		Contact block 60H 4NC		Contact block 60I 1NO+3NC		Contact block 60L 2NO+2NC									
Contacts	Pin no.	Contacts	Pin no.	Contacts	Pin no.	Contacts	Pin no.	Contacts	Pin no.	Contacts	Pin no.	Contacts	Pin no.	Contacts	Pin no.	Contacts	Pin no.	Contacts	Pin no.								
A1-A2	1-2	A1-A2	1-2	A1-A2	1-2	A1-A2	1-2	A1-A2	1-2	A1-A2	1-2	A1-A2	1-2	A1-A2	1-2	A1-A2	1-2	A1-A2	1-2	A1-A2	1-2						
NC	3-4	NC	3-4	NC	3-4	NO	3-4	NC	3-4	NC	3-4	NC	3-4	NC	3-4	NC	3-4	NC	3-4	NC	3-4	NC	3-4				
NC	5-6	NC	5-6	NC	5-6	NC	5-6	NC	5-6	NC	5-6	NC	5-6	NC	5-6	NC	5-6	NC	5-6	NC	5-6	NC	5-6	NC	5-6		
NO	7-8	NC	7-8	NC	7-8	NC	7-8	NC	7-8	NO	7-8	NC	7-8	NC	7-8	NC	7-8	NC	7-8	NO	7-8	NC	7-8	NO	7-8		
NO	9-10	NO	9-10	NC	9-10	NC	9-10	NO	9-10	NO	9-10	NC	9-10	NC	9-10	NC	9-10	NO	9-10	NO	9-10	NO	9-10	NO	9-10	NO	9-10

Contact block 60M 3NO+1NC		Contact block 60N 3NO+1NC		Contact block 60P 4NC		Contact block 60R 2NO+2NC		Contact block 60S 2NO+2NC		Contact block 60T 1NO+3NC		Contact block 60U 4NC		Contact block 60V 2NO+2NC		Contact block 60X 1NO+3NC		Contact block 60Y 2NO+2NC									
Contacts	Pin no.	Contacts	Pin no.	Contacts	Pin no.	Contacts	Pin no.	Contacts	Pin no.	Contacts	Pin no.	Contacts	Pin no.	Contacts	Pin no.	Contacts	Pin no.	Contacts	Pin no.								
A1-A2	1-2	A1-A2	1-2	A1-A2	1-2	A1-A2	1-2	A1-A2	1-2	A1-A2	1-2	A1-A2	1-2	A1-A2	1-2	A1-A2	1-2	A1-A2	1-2	A1-A2	1-2						
NO	3-4	NO	3-4	NC	3-4	NC	3-4	NC	3-4	NC	3-4	NC	3-4	NC	3-4	NO	3-4	NO	3-4	NC	3-4	NC	3-4				
NC	5-6	NC	5-6	NC	5-6	NC	5-6	NC	5-6	NC	5-6	NC	5-6	NC	5-6	NC	5-6	NC	5-6	NC	5-6	NC	5-6	NC	5-6		
NO	7-8	NO	7-8	NC	7-8	NO	7-8	NO	7-8	NC	7-8	NC	7-8	NC	7-8	NO	7-8	NC	7-8	NO	7-8	NO	7-8	NO	7-8		
NO	9-10	NO	9-10	NC	9-10	NO	9-10	NO	9-10	NO	9-10	NO	9-10	NC	9-10	NO	9-10	NC	9-10	NO	9-10	NO	9-10	NO	9-10	NO	9-10

Contact block 61A 1NO+3NC		Contact block 61B 2NO+2NC		Contact block 61C 3NO+1NC		Contact block 61D 3NO+1NC		Contact block 61E 3NO+1NC		Contact block 61G 3NO+1NC		Contact block 61H 2NO+2NC		Contact block 61M 3NO+1NC		Contact block 61R 1NO+3NC		Contact block 61S 3NO+1NC			
Contacts	Pin no.	Contacts	Pin no.	Contacts	Pin no.	Contacts	Pin no.	Contacts	Pin no.	Contacts	Pin no.	Contacts	Pin no.	Contacts	Pin no.	Contacts	Pin no.	Contacts	Pin no.		
A1-A2	1-2	A1-A2	1-2	A1-A2	1-2	A1-A2	1-2	A1-A2	1-2	A1-A2	1-2	A1-A2	1-2	A1-A2	1-2	A1-A2	1-2	A1-A2	1-2	A1-A2	1-2
NC	3-4	NC	3-4	NO	3-4	NO	3-4	NO	3-4	NO	3-4	NC	3-4	NO	3-4	NC	3-4	NO	3-4	NO	3-4
NC	5-6	NC	5-6	NC	5-6	NC	5-6	NC	5-6	NC	5-6	NC	5-6	NC	5-6	NC	5-6	NC	5-6	NC	5-6
NC	7-8	NO	7-8	NO	7-8	NO	7-8	NO	7-8	NO	7-8	NO	7-8	NO	7-8	NO	7-8	NC	7-8	NO	7-8
NO	9-10	NO	9-10	NO	9-10	NO	9-10	NO	9-10	NO	9-10	NO	9-10	NO	9-10	NO	9-10	NO	9-10	NO	9-10

**Note:** the wires connected to pins 11 and 12 of the M12 connector can be used to activate the LEDs in FG series configurations with freely connectable LEDs.



### Wiring diagram for M23 connectors

#### M23 connector, 12-pole

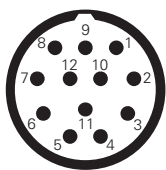

Contact block 60A 2NO+2NC		Contact block 60B 1NO+3NC		Contact block 60C 4NC		Contact block 60D 1NO+3NC		Contact block 60E 1NO+3NC		Contact block 60F 2NO+2NC		Contact block 60G 4NC		Contact block 60H 4NC		Contact block 60I 1NO+3NC		Contact block 60L 2NO+2NC							
Contacts	Pin no.	Contacts	Pin no.	Contacts	Pin no.	Contacts	Pin no.	Contacts	Pin no.	Contacts	Pin no.	Contacts	Pin no.	Contacts	Pin no.	Contacts	Pin no.	Contacts	Pin no.	Contacts	Pin no.				
A1-A2	1-2	A1-A2	1-2	A1-A2	1-2	A1-A2	1-2	A1-A2	1-2	A1-A2	1-2	A1-A2	1-2	A1-A2	1-2	A1-A2	1-2	A1-A2	1-2	A1-A2	1-2				
NC	3-4	NC	3-4	NC	3-4	NO	3-4	NC	3-4	NC	3-4	NC	3-4	NC	3-4	NC	3-4	NC	3-4	NC	3-4	NC	3-4		
NC	5-6	NC	5-6	NC	5-6	NC	5-6	NC	5-6	NC	5-6	NC	5-6	NC	5-6	NC	5-6	NC	5-6	NC	5-6	NC	5-6	NC	5-6
NO	7-8	NC	7-8	NC	7-8	NC	7-8	NC	7-8	NO	7-8	NC	7-8	NC	7-8	NC	7-8	NC	7-8	NC	7-8	NO	7-8	NO	7-8
NO	9-10	NO	9-10	NC	9-10	NC	9-10	NO	9-10	NO	9-10	NC	9-10	NC	9-10	NC	9-10	NO	9-10	NO	9-10	NO	9-10	NO	9-10
ground	11	ground	11	ground	11	ground	11	ground	11	ground	11	ground	11	ground	11	ground	11	ground	11	ground	11	ground	11	ground	11

Contact block 60M 3NO+1NC		Contact block 60N 3NO+1NC		Contact block 60P 4NC		Contact block 60R 2NO+2NC		Contact block 60S 2NO+2NC		Contact block 60T 1NO+3NC		Contact block 60U 4NC		Contact block 60V 2NO+2NC		Contact block 60X 1NO+3NC		Contact block 60Y 2NO+2NC									
Contacts	Pin no.	Contacts	Pin no.	Contacts	Pin no.	Contacts	Pin no.	Contacts	Pin no.	Contacts	Pin no.	Contacts	Pin no.	Contacts	Pin no.	Contacts	Pin no.	Contacts	Pin no.	Contacts	Pin no.						
A1-A2	1-2	A1-A2	1-2	A1-A2	1-2	A1-A2	1-2	A1-A2	1-2	A1-A2	1-2	A1-A2	1-2	A1-A2	1-2	A1-A2	1-2	A1-A2	1-2	A1-A2	1-2						
NO	3-4	NO	3-4	NC	3-4	NC	3-4	NC	3-4	NC	3-4	NC	3-4	NC	3-4	NC	3-4	NO	3-4	NC	3-4	NC	3-4				
NC	5-6	NC	5-6	NC	5-6	NC	5-6	NC	5-6	NC	5-6	NC	5-6	NC	5-6	NC	5-6	NC	5-6	NC	5-6	NC	5-6	NC	5-6		
NO	7-8	NO	7-8	NC	7-8	NO	7-8	NO	7-8	NC	7-8	NC	7-8	NC	7-8	NO	7-8	NC	7-8	NC	7-8	NO	7-8	NO	7-8		
NO	9-10	NO	9-10	NC	9-10	NO	9-10	NO	9-10	NO	9-10	NO	9-10	NC	9-10	NO	9-10	NC	9-10	NO	9-10	NO	9-10	NO	9-10	NO	9-10
ground	11	ground	11	ground	11	ground	11	ground	11	ground	11	ground	11	ground	11	ground	11	ground	11	ground	11	ground	11	ground	11		

Contact block 61A 1NO+3NC		Contact block 61B 2NO+2NC		Contact block 61C 3NO+1NC		Contact block 61D 3NO+1NC		Contact block 61E 3NO+1NC		Contact block 61G 3NO+1NC		Contact block 61H 2NO+2NC		Contact block 61M 3NO+1NC		Contact block 61R 1NO+3NC		Contact block 61S 3NO+1NC									
Contacts	Pin no.	Contacts	Pin no.	Contacts	Pin no.	Contacts	Pin no.	Contacts	Pin no.	Contacts	Pin no.	Contacts	Pin no.	Contacts	Pin no.	Contacts	Pin no.	Contacts	Pin no.	Contacts	Pin no.						
A1-A2	1-2	A1-A2	1-2	A1-A2	1-2	A1-A2	1-2	A1-A2	1-2	A1-A2	1-2	A1-A2	1-2	A1-A2	1-2	A1-A2	1-2	A1-A2	1-2	A1-A2	1-2						
NC	3-4	NC	3-4	NO	3-4	NO	3-4	NO	3-4	NO	3-4	NC	3-4	NC	3-4	NO	3-4	NC	3-4	NO	3-4	NO	3-4				
NC	5-6	NC	5-6	NC	5-6	NC	5-6	NC	5-6	NC	5-6	NC	5-6	NC	5-6	NC	5-6	NC	5-6	NC	5-6	NC	5-6	NC	5-6		
NC	7-8	NO	7-8	NO	7-8	NO	7-8	NO	7-8	NO	7-8	NO	7-8	NO	7-8	NO	7-8	NC	7-8	NO	7-8	NO	7-8	NO	7-8		
NO	9-10	NO	9-10	NO	9-10	NO	9-10	NO	9-10	NO	9-10	NO	9-10	NO	9-10	NO	9-10	NO	9-10	NO	9-10	NO	9-10	NO	9-10	NO	9-10
ground	11	ground	11	ground	11	ground	11	ground	11	ground	11	ground	11	ground	11	ground	11	ground	11	ground	11	ground	11	ground	11		

## Release button

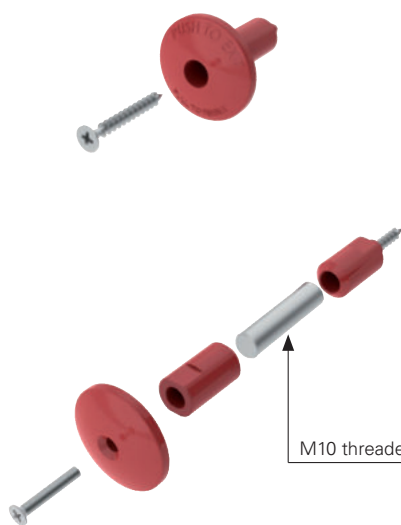

Article	Description
VF FG-LP15	Technopolymer release button for max. 15 mm wall thickness, supplied with screw
VF FG-LP30	Technopolymer release button for max. 30 mm wall thickness, supplied with screw
VF FG-LP40	Technopolymer release button for max. 40 mm wall thickness, supplied with screw
VF FG-LP60	Metal release button for max. 60 mm wall thickness, supplied with screw

Article	Description
VF FG-LPRG	Metal release button for wall thickness from 60 to 500 mm, supplied with 2 supports and 2 screws, without M10 threaded bar

The M10 bar can be supplied in zinc-plated steel with 1 m length. Article: AC 8512.

## Other release button lengths

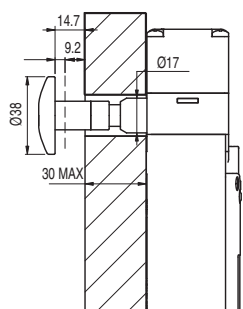

-LP30

For wall thickness  
15 ... 30 mm

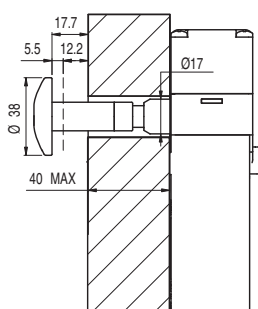

-LP40

For wall thickness  
30 ... 40 mm

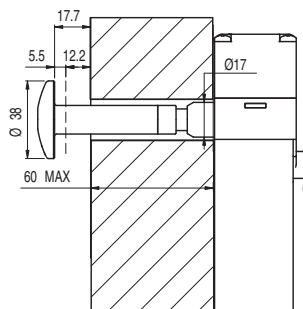

-LP60

For wall thickness  
40 ... 60 mm

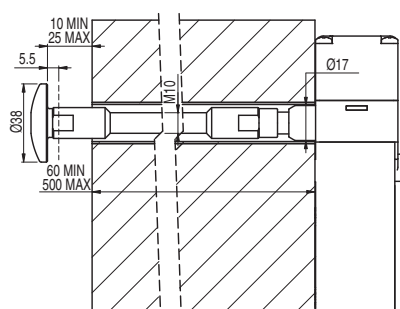

-LPRG

For wall thickness  
60 ... 500 mm

**-LP30, -LP40, -LP60:**

- Avoid bending and twisting the release button.
- To guarantee correct device operation, keep a distance of 10 ... 25 mm between the wall and the release button.
- The actuation path of the release button must always be kept clean. Dirt or chemical products could compromise the device operation.
- Periodically check the device for proper function.

**-LPRG:**

- Avoid bending and twisting the release button.
- On the inside of the wall, use a bushing or a tube with an inner diameter of  $18 \pm 0.5$  mm as a guide.
- Guide in the M10 threaded rod in such a way so as to prevent bending. The M10 threaded rod is not supplied with the device.
- Use medium-strength thread locker to secure the threaded rod.
- Do not exceed an overall length of 500 mm between the release button and the switch.
- To guarantee correct device operation, keep a distance of 10 ... 25 mm between the wall and the release button.
- The actuation path of the release button must always be kept clean. Dirt or chemical products could compromise the device operation.
- Periodically check the device for proper function.

## Accessories

Article	Description
VF KB2	Lock out device

Padlockable lock out device to prevent the actuator entry and the accidental closing of the door behind operators while they are in the danger area.  
To be used only with FG and FY series switches (e.g. FG 60AD1DOA). Hole diameter for padlocks: 9 mm.

Article	Description
VF KLA371	Set of two locking keys

Extra copy of the locking keys to be purchased if further keys are needed (standard supply: 2 units). The keys of all switches have the same code. Other codes on request.

All values in the drawings are in mm

Accessories See page 419

→ The 2D and 3D files are available at [www.pizzato.com](http://www.pizzato.com)

## Safety modules

Pizzato Elettrica offers its customers a wide range of safety modules. These were developed taking into consideration typical problems encountered during the monitoring of safety switches under actual operating conditions. Safety modules with instantaneous or delayed contacts for emergency circuits of type 0 (immediate stop) or type 1 (controlled stop).

Safety switches with solenoid of the FG series can be connected to safety modules for the realization of safety circuits up to PL e acc. to EN ISO 13849. For technical information or wiring diagrams, please contact our technical office.

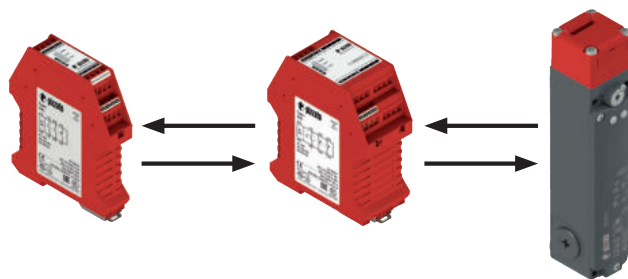

## Application example with safety timer

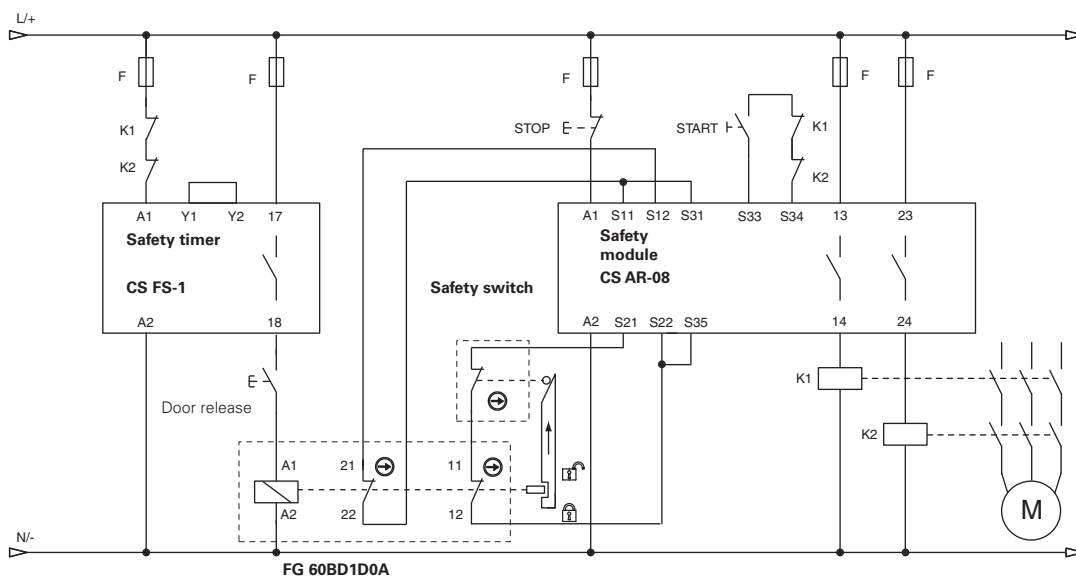

## Application example with safety module for standstill monitoring

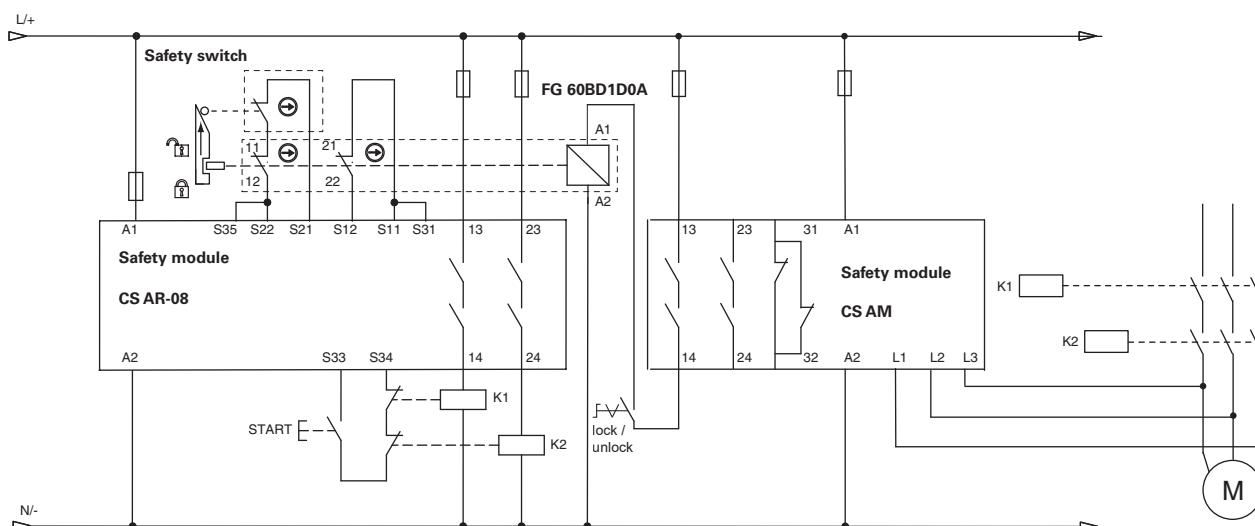

**Note:** The NC contacts of K1 and K2 are mechanically guided (EN 60947-4-1, Annex F)