

Description



These switches are used on machines where the hazardous conditions remain for a while, even after the machines have been switched off, for example because of mechanical inertia of pulleys, saw disks, parts under pressure or with high temperatures. Thus, the switches can also be used if individual guards are only to be opened under certain conditions.

The versions with solenoid actuated NC contacts are considered interlocks with locking in accordance with ISO 14119, and the product's label is marked with the symbol shown.



Head and release devices with variable orientation

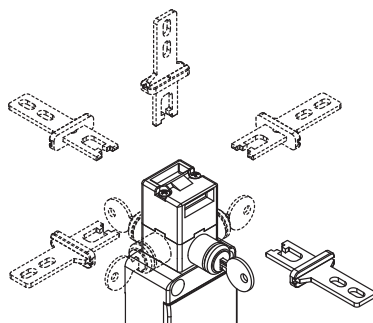

The head can be quickly turned to each of the four sides of the switch by unfastening the two fastening screws.

The auxiliary key release device can be rotated in 90° steps as well. This enables the switch to assume 32 different configurations.

Wide-ranging actuator travel

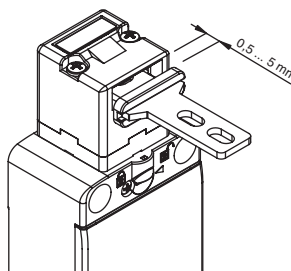

The actuation head of this switch features a wide range of travel. In this way the guard can oscillate along the direction of insertion (4.5 mm) without causing unwanted machine shutdowns. This wide range of travel is available in all actuators in order to ensure maximum device reliability.

Holding force of the locked actuator

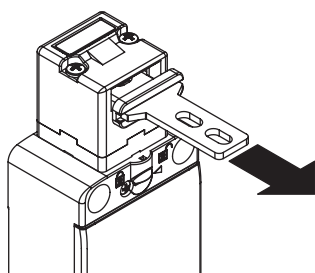

The robust interlocking system guarantees a maximum actuator holding force of $F_{1max} = 1100$ N.

Safety screws for actuators

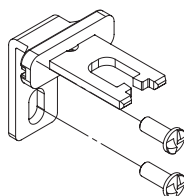

As required by EN ISO 14119, the actuator must be fixed immovably to the guard frame. Pan head safety screws with one-way fitting are available for this purpose. With this screw type, the actuators cannot be removed or tampered by using common tools. See accessories on page 419.

Protection degree IP67

IP67 These devices are designed to be used under the toughest environmental conditions, and they pass the IP67 immersion test acc. to EN 60529. They can therefore be used in all environments where the maximum degree of protection is required for the housing.

Contact blocks



Contact blocks with captive screws, finger protection, twin bridge contacts and double interruption for higher contact reliability. Versions with gold-plated contacts available. Available in multiple variants with actuation by actuator or by solenoid.

Turnable key release with lock

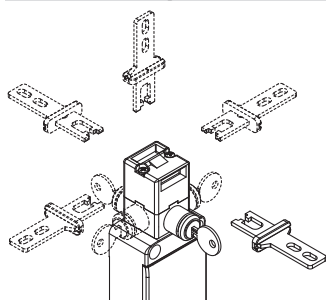

The auxiliary key release device is used to allow the maintenance or the entry into the machinery to authorized personnel only. Turning the key corresponds to actuating the solenoid: the actuator is released. The device can be turned, thereby enabling installation of the safety switch in the machine while the release device remains accessible on the outside of the guard.

Circuit board for monitoring the current consumption of the solenoid

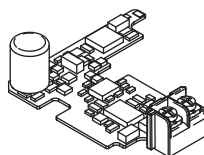

This technical solution resolves the problems that may derive from unstable power supply (machine distance from main transformers, voltage variation between night/day hours), allowing also a low solenoid power consumption and consequently enlarging the working temperature range of the switch.

Key release with triangular key



The auxiliary key release is also available with option V73, a variant with triangular key acc. to DIN 22417. This option can be used with installations in which the auxiliary release is to be actuated with a triangular key that is not normally available.

On request, option V70 is also available, with which the auxiliary release returns to the initial position with the aid of a spring.



Laser engraving



All FS series switches are permanently marked with a special laser system. As a result, the marking remains legible even under extreme operating conditions. Thanks to this system that does not use labels, the loss of plate data is prevented and a greater resistance of the marking is achieved over time.

Holding force of the unlocked actuator

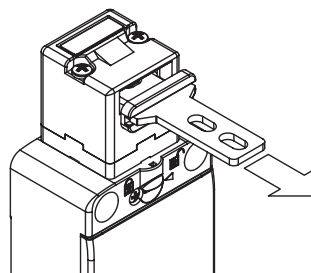

The inside of each switch features a device which holds the actuator in its closed position. Ideal for all those applications where several guards are unlocked simultaneously, but only one is actually opened. The device keeps all the unlocked guards in their position with a retaining force of approx. 30 N, stopping any vibrations or gusts of wind from opening them.

Two operating principles

D or E

The safety switches with solenoid offer two different operating principles for the actuator locking:

Operating principle D: locked actuator with de-energised solenoid. The actuator is released by applying the power supply to the solenoid.

Operating principle E: locked actuator with energised solenoid. The actuator is released by switching off the power supply to the solenoid. This version should only be used under certain conditions, since a power failure at the system will result in the immediate opening of the guard.

Sealable auxiliary release device



Switches with locked actuator with deactivated solenoid (function principle D) are equipped with an auxiliary release device for the solenoid to simplify installation of the switch and to facilitate entry into the danger zone in the event of a power failure. The auxiliary

release device acts on the switch exactly as if the solenoid was energised. As a result, it also actuates the electrical contacts. Can only be actuated with a couple of tools, this ensures adequate resistance to tampering. If required it can be sealed by means of the hole provided.

Cable outlets

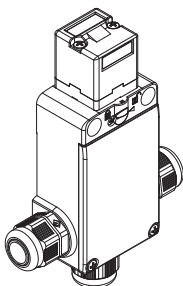

The switch is provided with three cable entries in different directions. This allows its application in series connections or in narrow places.

Gold-plated contacts

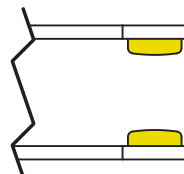

The contact blocks of these devices can be supplied gold-plated upon request. Ideal for applications with low voltages or currents; it ensures increased contact reliability. Available in two thicknesses (1 or 2.5 microns), it adapts perfectly to the various fields of application, ensuring a long endurance over time.

LED signalling lights



Thanks to the three threaded cable entries, the high luminosity LED signalling lights of the VF SL series can be installed on the switch.

The LED signalling lights can be easily installed by screwing them on one of the conduit entries not used for electric cables. They can be used for many different purposes: for example, to signal, from a distance, whether the switch has been actuated; whether the guard has closed correctly; or whether the guard is locked or unlocked.

For more information see chapter Accessories, page 419.

Selection diagram

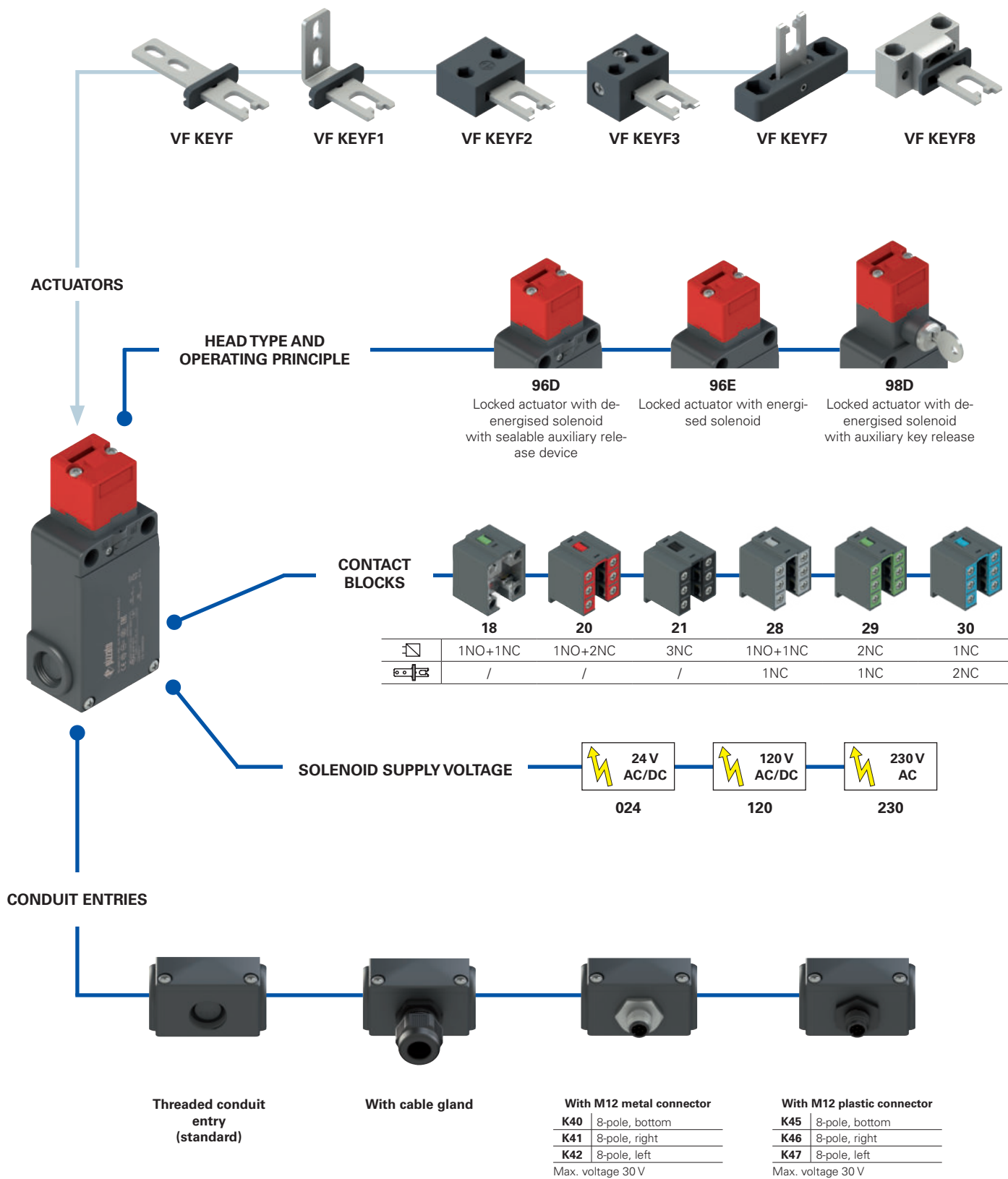

● product option
 → Sold separately as accessory



Code structure

Attention! The feasibility of a code number does not mean the effective availability of a product. Please contact our sales office.

article
options
options

FS 1896D024-F1GM2K40V34

Contact blocks		
	Contacts activated by the solenoid	Contacts activated by the actuator
18	1NO+1NC	/
20	1NO+2NC	/
21	3NC	/
28	1NO+1NC	1NC
29	2NC	1NC
30	1NC	2NC

Auxiliary release options (only for articles FS **98D**)	
	The key can be removed in locked and unlocked actuator position (standard)
V34	The key can be removed only in the locked position of the actuator
V70	Key release with triangular key with spring return
V73	Key release with triangular key, no spring return

Head type and operating principle	
96D	locked actuator with de-energised solenoid with sealable auxiliary release device
96E	locked actuator with energised solenoid
98D	locked actuator with de-energised solenoid with auxiliary key release

Solenoid supply voltage	
024	24 Vac/dc (-10% ... +25%)
120	120 Vac/dc (-15% ... +20%)
230	230 Vac (-15% ... +10%)

Actuators	
	without actuator (standard)
F	straight actuator VF KEYF
F1	angled actuator VF KEYF1
F2	jointed actuator VF KEYF2
F3	jointed actuator adjustable in two directions VF KEYF3
F7	jointed actuator adjustable in one direction VF KEYF7
F8	universal actuator VF KEYF8

Pre-installed cable glands or connectors	
	no cable gland or connector (standard)
K23	cable gland for cables Ø 6 ... 12 mm
...	...
K40	M12 metal connector, 8-pole
...	...
K45	M12 plastic connector, 8-pole
...	...

For the complete list of possible combinations please contact our technical department.

Threaded conduit entry	
M2	M20x1.5 (standard)
	PG 13.5

Contact type	
	silver contacts (standard)
G	silver contacts with 1 µm gold coating
G1	silver contacts, 2.5 µm gold coating (not for contact blocks 20, 21, 28, 29, 30)

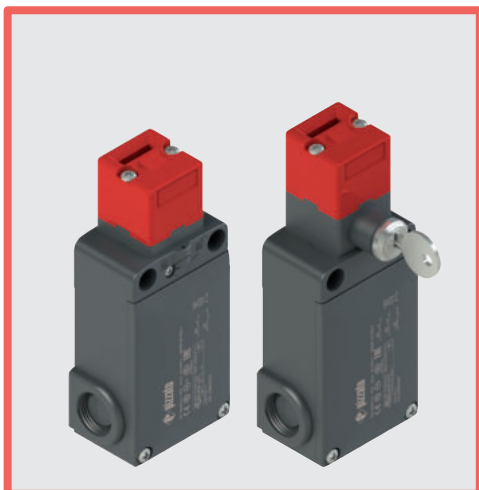

Main features

- Technopolymer housing, three conduit entries
- Protection degree IP67
- 6 contact blocks available
- 6 stainless steel actuators available
- 3 solenoid supply voltages available
- Versions with auxiliary release device or turnable lock
- Operation with energised or de-energised solenoid

Quality marks:



IMQ approval:	CA02.03808
UL approval:	E131787
CCC approval:	2021000305000098
EAC approval:	RU C-IT.YT03.B.00035/19

Technical data

Housing

Housing made of glass fibre reinforced technopolymer, self-extinguishing, shock-proof and with double insulation:

Three knock-out threaded conduit entries:	M20x1.5 (standard)
Protection degree:	IP67 acc. to EN 60529 with cable gland of equal or higher protection degree

General data

SIL (SIL CL) up to:	SIL 3 acc. to EN 62061
Performance Level (PL) up to:	PL e acc. to EN ISO 13849-1
Interlock with mechanical lock, coded:	type 2 acc. to EN ISO 14119
Coding level:	low acc. to EN ISO 14119
Safety parameters:	
B_{10D} :	4,000,000 for NC contacts
Mission time:	20 years
Ambient temperature:	-25°C ... +60°C
Max. actuation frequency:	600 operating cycles/hour
Mechanical endurance:	800,000 operating cycles
Max. actuation speed:	0.5 m/s
Min. actuation speed:	1 mm/s
Maximum force before breakage F_{1max} :	1100 N (head 96), 900 N (head 98) acc. to EN ISO 14119
Max. holding force F_{Zh} :	846 N (head 96), 692 N (head 98) acc. to EN ISO 14119
Maximum clearance of locked actuator:	4.5 mm
Released actuator extraction force:	30 N
Tightening torques for installation:	see page 441
Wire cross-sections and wire stripping lengths:	see page 466

Solenoid

Duty cycle:	100% ED (continuous operation)
Solenoid inrush power:	20 VA 0.1 s (24 V) 18 VA 0,1 s (120 V) 18 VA 0,1 s (230 V)
Solenoid consumption:	4 VA
Average overall consumption:	10 VA

Notes: Calculate the power supply using the average overall consumption. Please consider the solenoid inrush power in order to avoid intervention of overload-protection in case of electronic power supply.

In compliance with standards:

IEC 60947-5-1, IEC 60947-1, IEC 60204-1, EN ISO 14119, EN ISO 12100, IEC 60529, IEC 61000-6-2, IEC 61000-6-3, EN IEC 63000, BG-GS-ET-15, BG-GS-ET-19, UL 508, CSA C22.2 No. 14.

Approvals:

EN 60947-5-1, UL 508, CSA C22.2 No. 14, GB/T14048.5

Compliance with the requirements of:

Machinery Directive 2006/42/EC, EMC Directive 2014/30/EU, RoHS Directive 2011/65/EU.

Positive contact opening in conformity with standards:

IEC 60947-5-1, EN 60947-5-1.

⚠ If not expressly indicated in this chapter, for correct installation and utilization of all articles see the instructions given on pages 443 to 454.

Electrical data

Utilization category

without connector	Thermal current (I_{th}):	10 A	Alternating current: AC15 (50-60 Hz)	
	Rated insulation voltage (U_i):	500 Vac 600 Vdc	U_e (V)	250 400 500
	Rated impulse withstand voltage (U_{imp}):	400 Vac 500 Vdc (contact blocks 20, 21, 28, 29, 30)	I_e (A)	6 4 1
		6 kV	Direct current: DC13	
with M12 connector, 8-pole	Conditional short circuit current:	4 kV (contact blocks 20, 21, 28, 29, 30)	U_e (V)	24 125 250
	Protection against short circuits:	1000 A acc. to EN 60947-5-1	I_e (A)	3 0.55 0.3
	Pollution degree:	type aM fuse 10 A 500 V		
		3		
with M12 connector, 8-pole	Thermal current (I_{th}):	2 A	Alternating current: AC15 (50-60 Hz)	
	Rated insulation voltage (U_i):	30 Vac 36 Vdc	U_e (V)	24
	Protection against short circuits:	type gG fuse 2 A 500 V	I_e (A)	2
	Pollution degree:	3	Direct current: DC13	
			U_e (V)	24
			I_e (A)	2



Features approved by IMQ

Rated insulation voltage (U_i): 500 Vac
 400 Vac (for contact blocks 20, 21, 28, 29, 30)
 Conventional free air thermal current (I_{th}): 10 A
 Protection against short circuits: type aM fuse 10 A 500 V
 Rated impulse withstand voltage (U_{imp}): 6 kV
 4 kV (for contact blocks 20, 21, 28, 29, 30)
 Protection degree of the housing: IP67
 MV terminals (screw terminals)
 Pollution degree: 3
 Utilization category: AC15
 Operating voltage (U_{op}): 400 Vac (50 Hz)
 Operating current (I_o): 3 A
 Forms of the contact element: Zb, Y+Y+X, Y+Y+Y, Y+X+X
 Positive opening contacts on contact blocks 18, 20, 21, 28, 29, 30
 In compliance with standards: EN 60947-1, EN 60947-5-1, fundamental requirements of the Low Voltage Directive 2014/35/EU.

Please contact our technical department for the list of approved products.

Features approved by UL

Electrical Ratings: Q300 pilot duty (69 VA, 125-250 V dc)
 A600 pilot duty (720 VA, 120-600 V ac)
 Environmental Ratings: Types 1, 4X, 12, 13
 Use 60 or 75 °C copper (Cu) conductor and wire size range 12, 14 AWG, stranded or solid. The terminal tightening torque of 7.1 lb in (0.8 Nm).

Please contact our technical department for the list of approved products.

Wiring diagram for M12 connectors

Contact block 18 1NO+1NC		Contact block 20 1NO+2NC		Contact block 21 3NC		Contact block 28 1NO+2NC		Contact block 29 3NC		Contact block 30 3NC	
M12 connector, 8-pole		M12 connector, 8-pole		M12 connector, 8-pole		M12 connector, 8-pole		M12 connector, 8-pole		M12 connector, 8-pole	
Contacts	Pin no.	Contacts	Pin no.	Contacts	Pin no.	Contacts	Pin no.	Contacts	Pin no.	Contacts	Pin no.
A1-A2	1-2	A1-A2	1-2	A1-A2	1-2	A1-A2	1-2	A1-A2	1-2	A1-A2	1-2
NC	3-4	NC	3-4	NC	3-4	NC	3-4	NC	3-4	NC	3-4
NO	5-6	NC	5-6	NC	5-6	NC	5-6	NC	5-6	NC	5-6
		NO	7-8	NC	7-8	NO	7-8	NC	7-8	NC	7-8



Operating principle

The operating principle of these safety switches allows three different operating states:

state A: with inserted and locked actuator

state B: with inserted but not locked actuator

state C: with extracted actuator

All or some of these states can be monitored by means of electrical contacts with positive opening by selecting the appropriate contact blocks. In detail, contact blocks that have electric contacts marked with the symbol of the solenoid () are switched in the transition between the state A and state B, while the electric contacts marked with the symbol of the actuator () are switched between state B and state C.

It is also possible to choose between two operating principles for the actuator locking:

- Operating principle D: locked actuator with de-energised solenoid. The actuator is released by applying the power supply to the solenoid (see example of the operating phases).
- Operating principle E: locked actuator with energised solenoid. The actuator is released by switching off the power supply to the solenoid. This version should only be used under certain conditions, since a power failure at the system will result in the immediate opening of the guard.

Example: operating phases with FS 2896D024-F1 (switch with operating principle D)

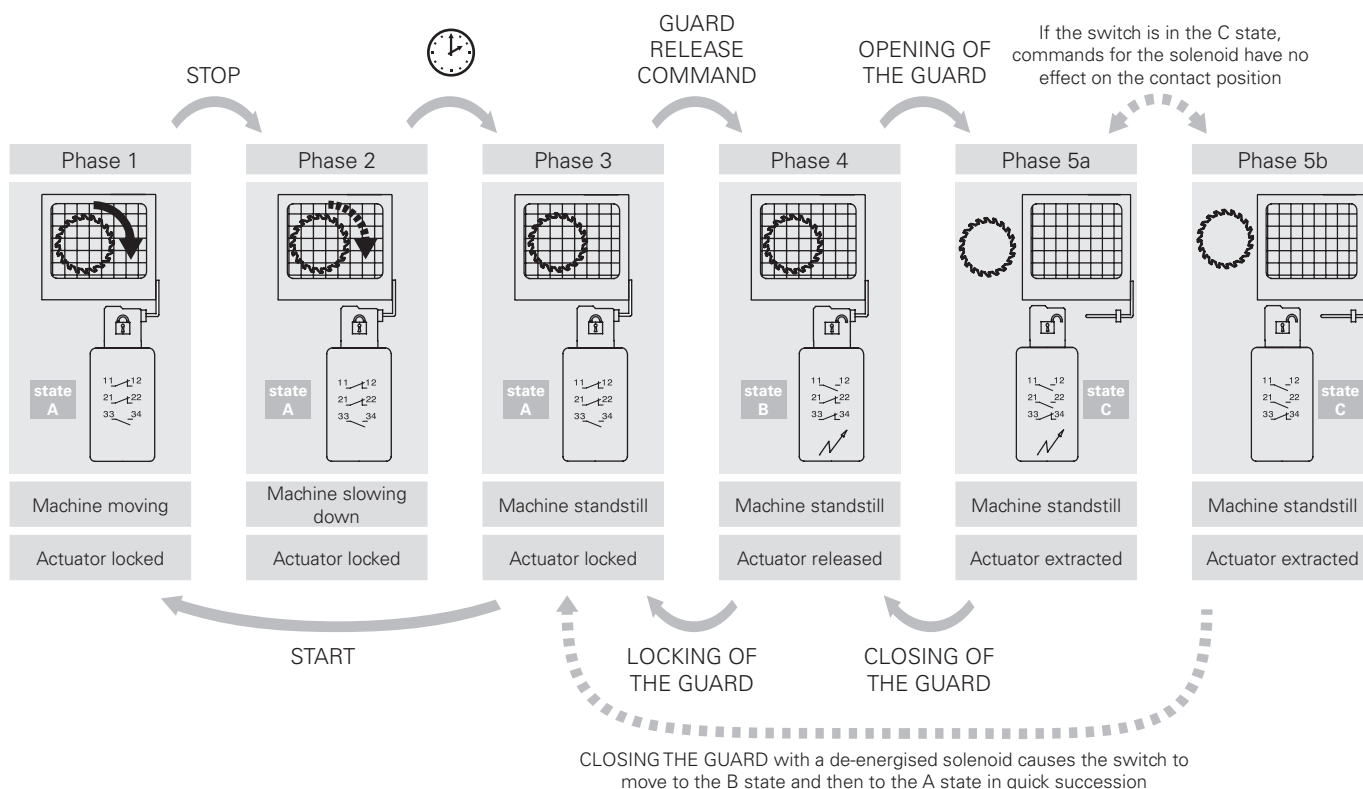

Installation of two or more switches connected to the same power supply

24 V AC/DC versions only

- This operation is intended to reduce the effects of the combined solenoid inrush currents on the power supply and should only be executed if necessary and with great care.
- Switch off the power supply.
- Open the switch cover.
- Loosen the two screws that secure the black plastic protective cover of the solenoid to the switch body and remove the plastic protective cover.
- Use a pin to set the selector switch so that each switch has a different combination (see figure at the side). If more than two switches are installed, repeat the combinations for any next set of two switches.
- Reposition the black plastic protective cover and tighten the two screws with a torque of 0.8 Nm.

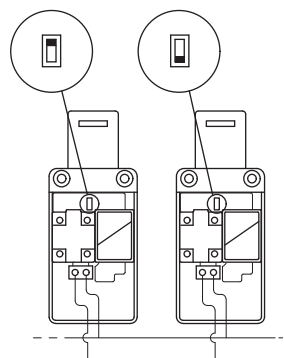



Contact positions related to switch states

Operating state	Operating principle D locked actuator with de-energised solenoid			Operating principle E locked actuator with energised solenoid		
	state A	state B	state C	state A	state B	state C
Actuator	Inserted and locked	Inserted and released	Extracted	Inserted and locked	Inserted and released	Extracted
Solenoid	De-energised	Energised	-	Energised	De-energised	-

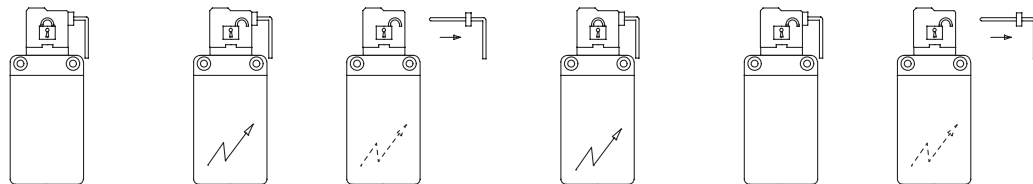

FS 18 1NO+1NC controlled by the solenoid		11 — 12	11 — 12	11 — 12	11 — 12	11 — 12	11 — 12
		23 — 24	23 — 24	23 — 24	23 — 24	23 — 24	23 — 24
FS 20 1NO+2NC controlled by the solenoid		11 — 12	11 — 12	11 — 12	11 — 12	11 — 12	11 — 12
		21 — 22	21 — 22	21 — 22	21 — 22	21 — 22	21 — 22
		33 — 34	33 — 34	33 — 34	33 — 34	33 — 34	33 — 34
FS 21 3NC controlled by the solenoid		11 — 12	11 — 12	11 — 12	11 — 12	11 — 12	11 — 12
		21 — 22	21 — 22	21 — 22	21 — 22	21 — 22	21 — 22
		31 — 32	31 — 32	31 — 32	31 — 32	31 — 32	31 — 32
FS 28 1NO+1NC controlled by the solenoid 1NC controlled by the actuator		11 — 12	11 — 12	11 — 12	11 — 12	11 — 12	11 — 12
		21 — 22	21 — 22	21 — 22	21 — 22	21 — 22	21 — 22
		33 — 34	33 — 34	33 — 34	33 — 34	33 — 34	33 — 34
FS 29 2NC controlled by the solenoid 1NC controlled by the actuator		11 — 12	11 — 12	11 — 12	11 — 12	11 — 12	11 — 12
		21 — 22	21 — 22	21 — 22	21 — 22	21 — 22	21 — 22
		31 — 32	31 — 32	31 — 32	31 — 32	31 — 32	31 — 32
FS 30 1NC controlled by the solenoid 2NC controlled by the actuator		11 — 12	11 — 12	11 — 12	11 — 12	11 — 12	11 — 12
		21 — 22	21 — 22	21 — 22	21 — 22	21 — 22	21 — 22
		31 — 32	31 — 32	31 — 32	31 — 32	31 — 32	31 — 32

Limits of use

Do not use where dust and dirt may penetrate in any way into the head and deposit there. Especially not where powder, shavings, concrete or chemicals are sprayed. Adhere to the EN ISO 14119 requirements regarding low level of coding for interlocks. Do not use in environments with presence of explosive or flammable gas. In these cases, use ATEX products (see dedicated Pizzato catalogue).

Attention! These switches alone are not suitable for applications where operators may physically enter the dangerous area, because an eventual closing of the door behind them could restart the machine operation. In these cases, the maintenance personnel must use the actuator entry locking device VF KB1 shown on page 165.

Contact type:

L = slow action

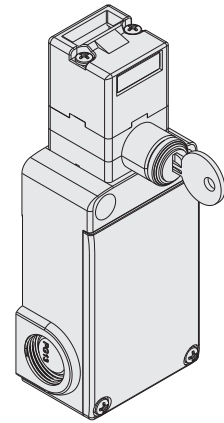
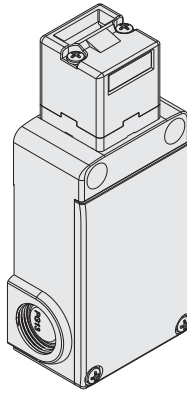
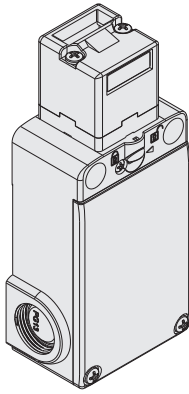

Operating principle	Operating principle D, with sealable auxiliary release device, without actuator		Operating principle E, without actuator		Operating principle D, with auxiliary key release, without actuator		
Contact block							
18	L	FS 1896D024-M2		1NO+1NC	FS 1896E024-M2		1NO+1NC
20	L	FS 2096D024-M2		1NO+2NC	FS 2096E024-M2		1NO+2NC
21	L	FS 2196D024-M2		3NC	FS 2196E024-M2		3NC
28	L	FS 2896D024-M2		1NO+2NC	FS 2896E024-M2		1NO+2NC
29	L	FS 2996D024-M2		3NC	FS 2996E024-M2		3NC
30	L	FS 3096D024-M2		3NC	FS 3096E024-M2		3NC
Actuating force	30 N (40 N)						
Travel diagrams	Page 466						

Legend: With positive opening according to EN 60947-5-1, interlock with lock monitoring acc. to EN ISO 14119

Auxiliary key release with triangular key



Articles with the V70 and V73 option have an auxiliary key release with a triangular key that meets DIN 22417 standards. This type of lock can be used in situations where the switch must only be unlocked using the corresponding triangular key, a tool which is not usually available. There are two versions of the triangular key release: with a spring return (option V70) and without a spring return (option V73).

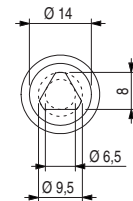

Accessories

Article	Description
VF KB1	Lock out device

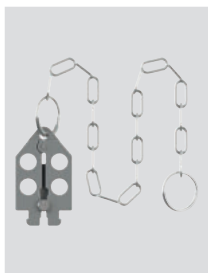

Padlockable lock out device to prevent the actuator entry and the accidental closing of the door behind operators while they are in the danger area. Hole diameter for padlocks: 9 mm.

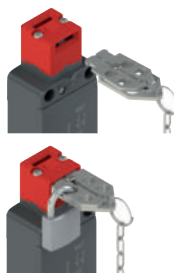

Article	Description
VF KLA371	Set of two locking keys

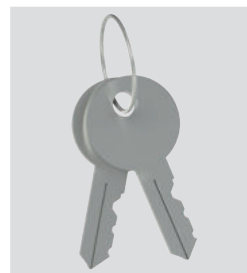



Extra copy of the locking keys to be purchased if further keys are needed (standard supply: 2 units). The keys of all switches have the same code. Other codes on request.



Stainless steel actuators

IMPORTANT: These actuators can be used only with items of the FD, FP, FL, FC, and FS series (e.g. FS 1896D024-M2).
Low level of coding acc. to EN ISO 14119.

	Article	Description
	VF KEYF	Straight actuator

	Article	Description
	VF KEYF1	Angled actuator

	Article	Description
	VF KEYF2	Jointed actuator

The actuator can flex in four directions for applications where the guard alignment is not precise.

	Article	Description
	VF KEYF3	Actuator adjustable in two directions

Actuator adjustable in two directions for guards with reduced dimensions.

	Article	Description
	VF KEYF7	Actuator adjustable in one direction

Actuator adjustable in one direction for guards with reduced dimensions.

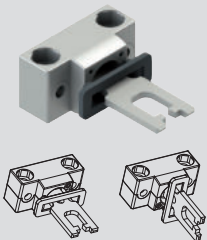
	Article	Description
	VF KEYF8	Universal actuator

Jointed actuator for guards with poor alignment, adjustable in two dimensions for small doors; can be mounted in various positions. The metal fixing body has two pairs of bore holes; it is provided for rotating the working plane of the actuator by 90°.

Dimensional drawings

Switch FS ●●96D●●●
Operating principle D,
with sealable auxiliary release device

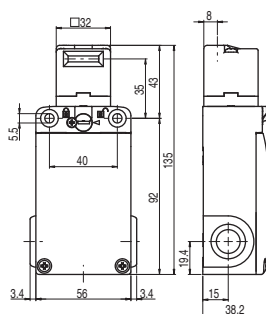

Switch FS ●●96E●●●
Operating principle E

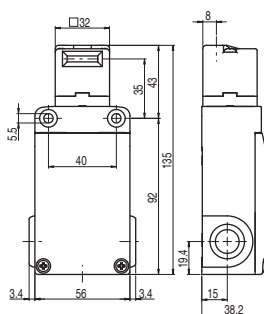

Switch FS ●●98D●●●
Operating principle D
with auxiliary key release

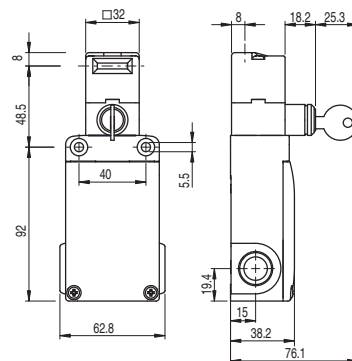

Actuator VF KEYF

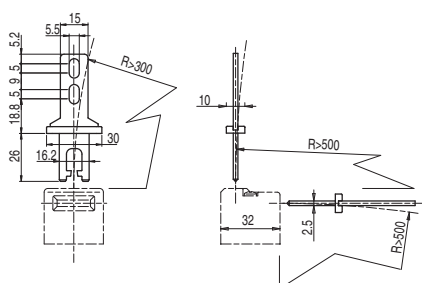

Actuator VF KEYF1

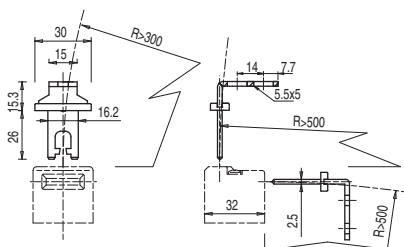

Actuator VF KEYF2

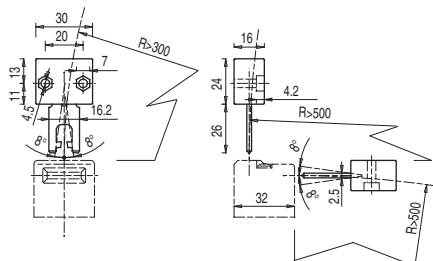

Actuator VF KEYF3

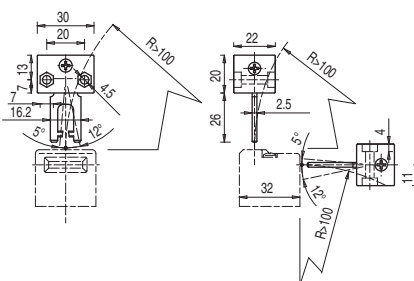

Actuator VF KEYF7

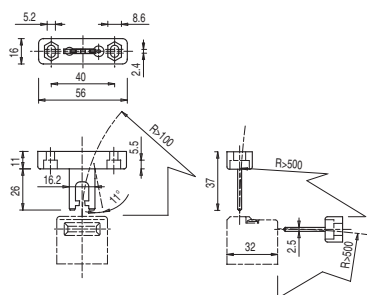

Actuator VF KEYF8

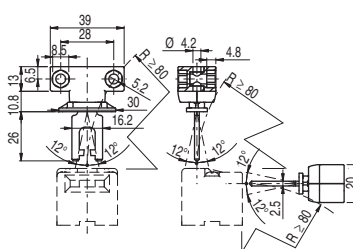

All values in the drawings are in mm

