

PRODUCT DATASHEET

DP HOUSING 1500 P 2XLAMP IP65

DAMP PROOF HOUSING GEN 3 | Damp-proof luminaire for T8 LED lamps with tool-free luminaire connector



Areas of application

- Parking lots, warehouses, production areas
- Car parks and underpasses
- Garages

Product benefits

- Easy and quick installation
- Prewired for easy installation of tubular AC LED lamps
- Toolless installation
- Robust housing
- Sustainable solution thanks to exchangeable light sources
- 5 years guarantee

Product features

- Luminaire housing, available for 1 or 2 T8 LED tubes
- Suitable for LED TUBE T8 EM and LED TUBE T8 CONNECTED
- Type of protection: IP65
- Integrated electrical fuse



TECHNICAL DATA

Electrical data

Nominal voltage	220...240 V
Mains frequency	50...60 Hz
Protection class	II

Dimensions & Weight

Length	1585.00 mm
Width	95.00 mm
Height	70.00 mm
Product weight	1099.00 g

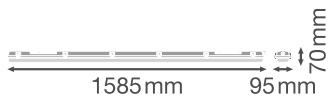

DP HOUSING 1500 P 2XLAMP
IP65

Materials & Colors

Product color	Gray
Housing color	Gray
Body material	Polycarbonate (PC)
Cover material	Polycarbonate (PC)
Light emitting surface material	Polycarbonate (PC)
Glow Wire Test according to IEC 60695-2-12	850 °C
Mercury content	0.0 mg

Application & Mounting

Ambient temperature range	-30...+40 °C
Temperature range at storage	-20...+80 °C

Type of connection	Screwless terminal, 3-Pole (N, E, L)
Type of protection	IP65
Protection class IK (shock resistance)	IK08
Dimmable	No
Mounting type	Surface
Mounting location	Ceiling
Application environment	Indoor
With light source	No
Holder designation	G13

Certificates & Standards

Standards	CE / TÜV Rheinland / EAC / UKCA
Luminaire with limited surface temperature, "D sign"	No
Ball shot safe	No





Accessories Optional

Product image	Product name	EAN
	DP HOUSING 1500 2xLAMP TH-KIT 5x2.5	4058075695139



EQUIPMENT / ACCESSORIES



- All required accessories included
- Through-wiring cable kit available

DOWNLOAD DATA

Documents and certificates	Document name
 User instruction / safety instructions	DP HOUSING
 Legal information	LI DP HOUSING
 Legal information	Informationstext 18 Abs 4 ElektroG
 Declarations of conformity	DP HOUSING

Documents and certificates		Document name
	Declarations of conformity UKCA	DP HOUSING

Photometric and lighting design files		Document name
	IES file (IES)	DP HOUSING 1500 P 2xL IP65 incl LEDTUBE CON P 24W
	LDT file (Eulumdat)	DP HOUSING 1500 P 2xL IP65 incl LEDTUBE CON P 24W
	ULD file (DIALux)	DP HOUSING 1500 P 2XLAMP IP65

CAD/BIM files		Document name
	BIM Revit 3D	Damp Proof Housing G3
	CAD STEP 3D	DP HOUSING G3 2 1500

Tender texts		Document name
	Tender documents	DAMP PROOF HOUSING GEN 3 1500 P 2XLAMP IP65-EN

LOGISTICAL DATA

Product code	Packaging unit (Pieces/Unit)	Dimensions (length x width x height)	Gross weight	Volume
4099854118210	Folding box 1	98 mm x 1,577 mm x 75 mm	1399.00 g	11.59 dm ³
4099854118227	Shipping box 6	1,592 mm x 208 mm x 237 mm	9174.00 g	78.48 dm ³

The mentioned product code describes the smallest quantity unit which can be ordered. One shipping unit can contain one or more single products. When placing an order, for the quantity please enter single or multiples of a shipping unit.

ADDITIONAL CATALOG INFORMATION

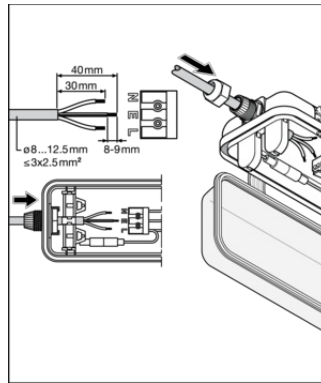
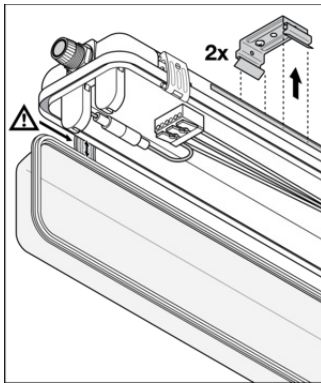

T8 FL (18W, 36W, 58W)

**G13 LED
LED TUBE EM / AC 220-240V**

	220-240 V / 50/60 Hz
DP HOUSING 600 P 1XLAMP	1x G13 LED TUBE (0.6 m)
DP HOUSING 600 P 2XLAMP	2x G13 LED TUBE (0.6 m)
DP HOUSING 1200 P 1XLAMP	1x G13 LED TUBE (1.2 m)
DP HOUSING 1200 P 2XLAMP	2x G13 LED TUBE (1.2 m)
DP HOUSING 1500 P 1XLAMP	1x G13 LED TUBE (1.5 m)
DP HOUSING 1500 P 2XLAMP	2x G13 LED TUBE (1.5 m)

References / Links

– For Guarantee see www.ledvance.com/guarantee

DISCLAIMER

Subject to change without notice. Errors and omission excepted. Always make sure to use the most recent release.