

Esmi Impresia Red Wall Mounted Sounder

Instruction Sheet
R10227GB0



Schneider Electric Fire & Security Oy

Sokerilinnantie 11 C
FI-02600 Espoo, Finland
Tel: +358 10 446 511
Website: www.se.com
Document number: R10227GB0
Published: 18.12.2020





© 2020 – Schneider Electric. All Rights Reserved. This information is only to be used as guidance. Subject to changes and errors.



1 Esmi Impresia Red Wall Mounted Sounder

Esmi Impresia Red Wall Mounted Sounder (FFS06741011) is an addressable wall mount sounder with built-in isolator module designed for installing in addressable fire alarm systems with Esmi ELC loop controller supporting Schneider Electric communication protocol. The sounder is compatible with fire bases Esmi Impresia Standard Base (FFS06741018) for ceiling mounting and Esmi Impresia Red IP65 Deep Base (FFS06741013) for wall mounting. EN 54-3/17 approved and for indoor and outdoor use.

The address setting is done by the panel or handheld addressing device. The address range is 1-250.

Installation

 IP21C (EN54-3)*
 IP65 (EN60529)**
 -10°C + +50°C
 ~183g

 Indoor use*
 Outdoor use**

* When used with Esmi Impresia Standard Base
 ** When used with Esmi Impresia Red IP65 Deep Base

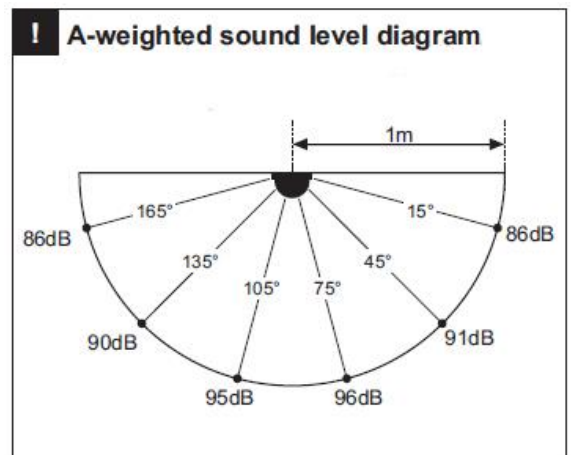



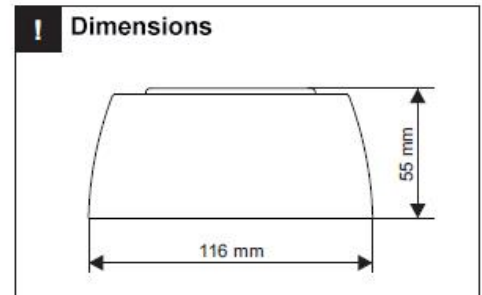







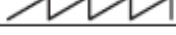



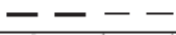











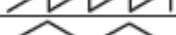
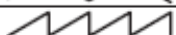

 17
 1293
 DOP: DP20027
 Made in Bulgaria
 EN 54-3:2001
 EN 54-3:2001/A1:2002
 EN 54-3:2001/A2:2006
 EN 54-17:2005
 EN 54-17:2005/AC:2007
 Sounder Type A

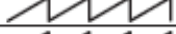
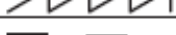

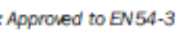
Essential characteristics	Performance
Performance under fire conditions	Pass
Operational reliability	Pass
Durability:	
Temperature resistance	Pass
Humidity resistance	Pass
Shock and vibration resistance	Pass
Corrosion resistance	Pass
Resistance to ingress	Pass
Electrical stability	Pass

1.1 Supported tone types and description

Tone	Tone Type	Tone Description / Application
1		970Hz
2		800Hz/970Hz @ 2Hz
3		800Hz - 970Hz @ 1Hz
4		970Hz 1s OFF/1s ON
5		970Hz, 0.5s/ 630Hz, 0.5s
6		554Hz, 0.1s/ 440Hz, 0.4s (AFNOR NF S 32 001)
7		500 - 1200Hz, 3.5s/ 0.5s OFF (NEN 257 5:2000)
8		420Hz 0.625s ON/0.625s OFF (Australia AS1670 Alert tone)
9		500 - 1200Hz, 0.5s/ 0.5s OFF x 3/1.5s OFF (AS1670 Evacuation)
10		550Hz/440Hz @ 0.5Hz
11		970Hz, 0.5s ON/0.5s OFF x 3/ 1.5s OFF (ISO 8201)
12		2850Hz, 0.5s ON/0.5s OFF x 3/1.5s OFF (ISO 8201)
13		1200Hz - 500Hz @ 1Hz (DIN 33 404)
14		400Hz
15		550Hz, 0.7s/1000Hz, 0.33s
16		1500Hz - 2700Hz @ 3Hz
17		750Hz
18		2400Hz
19		660Hz
20		660Hz 1.8s ON/1.8s OFF
21		660Hz 0.15s ON/0.15s OFF
22		510Hz, 0.25s/ 610Hz, 0.25s
23		800/1000Hz 0.5s each (1Hz)
24		250Hz - 1200Hz @ 1.2Hz
25		500Hz - 1200Hz @ 0.33Hz
26		2400Hz - 2900Hz @ 9Hz
27*		2400Hz - 2900Hz @ 3Hz 2500Hz (main sound frequency)
28		800Hz - 970Hz @ 100Hz
29		800Hz - 970Hz @ 9Hz
30		800Hz - 970Hz @ 3Hz
31		800Hz, 0.25s ON/1s OFF
32		500Hz - 1200Hz, 3.75s/0.25s OFF (AS2220)

* Note: Approved to EN54-3 only!

1.2 Installation Instructions

Attention: Turn power off the loop circuit before installing the mounted sounder!

1. Choose the proper place for installation of the device.
2. Set the module address using programmer or directly from addressable fire panel
3. Mount the fire base on the ceiling or on the wall of the protected premises using fixings according the mounting surface.
4. Connect the base to the fire panel using the wiring diagram.
5. Insert the device into the base and rotate clockwise until it drops into place - the short mark on the base fits with that on the sounder body. Continue to rotate the sounder until its mark coincides with the long mark on the base - a click is heard.
6. Program the device parameters.
7. Test the sounder for proper operation.

