

PRODUCT DATASHEET

DL ALU EM DN200 35 W 6500 K AT 3H WT

DOWNLIGHT ALU EMERGENCY | Downlight luminaires with aluminum housing and integrated emergency lighting function



Areas of application

- Emergency illumination of escape routes
- Antipanic lighting
- Buildings requiring up to 3 h emergency light operation
- Direct replacement for luminaires with compact fluorescent lamps
- General illumination
- Public areas
- Corridors, stairways, entrance areas
- Shops

Product benefits

- Seamless integration of luminaires with emergency lighting function into general lighting
- Easy wiring thanks to included prewired driver and battery for Emergency lighting function
- Simple testing of luminaires with emergency lighting function thanks to integrated automatic test function
- Convenient visualization of results of automatic test with an included control LED
- Operation of integrated emergency lighting function with long life LiFePO4 battery with 3h battery discharge time
- High luminous efficacy in normal operation
- Energy savings of up to 60 % compared to luminaires that use CFL
- Very homogenous light
- Functional design
- Easy installation with fast connection
- 3 years guarantee



Product features

- Luminaire suited for normal lighting and emergency lighting
- Certified according to European norms (EN 60598-1:2015; EN 60598-2-22:2014)
- Self-contained luminaires
- Emergency lighting function: battery discharge time of 3 h
- Function test of emergency lighting: automatic (AT)
- Battery technology: LiFePO4
- Diameter of required ceiling cut-out: 150 mm or 200 mm (depending on version)
- Type of protection: IP44

TECHNICAL DATA

Electrical data

Nominal wattage	35.00 W
Nominal voltage	220...240 V
Mains frequency	50...60 Hz
Nominal current	125 mA
Inrush current	9 A
Inrush current time T_{h50}	100 μ s
Max. number of luminaires per miniature circuit breaker B16	34
Max. number of luminaires per miniature circuit breaker C10	29
Max. number of luminaires per miniature circuit breaker C16	46
Power factor λ	> 0.90
Total harmonic distortion	< 15 %
Protection class	II
Operating mode	External LED driver

Photometrical data

Luminous flux	3150 lm
Luminous efficacy	90 lm/W
Color temperature	6500 K
Light color (designation)	Cool Daylight
Color rendering index Ra	> 80
Standard deviation of color matching	≤ 6 sdc _m
Luminous intensity	-
Flickering metric (Pst LM)	-
Stroboscope effect metric (SVM)	-
Photobiological safety group acc. to EN62778	RG0
Photobiological safety group acc. to EN62471	RG0
Beam angle	100 °

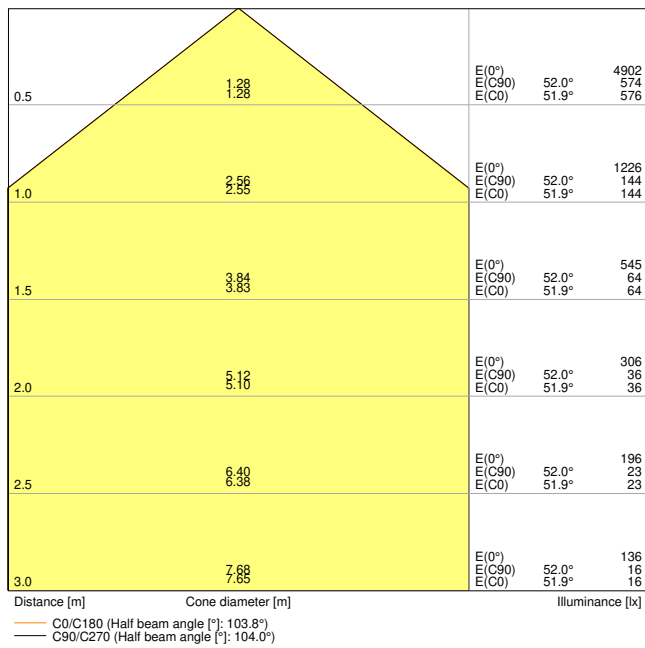

DL ALU DN200 35W 6500K WT EM AT 3H

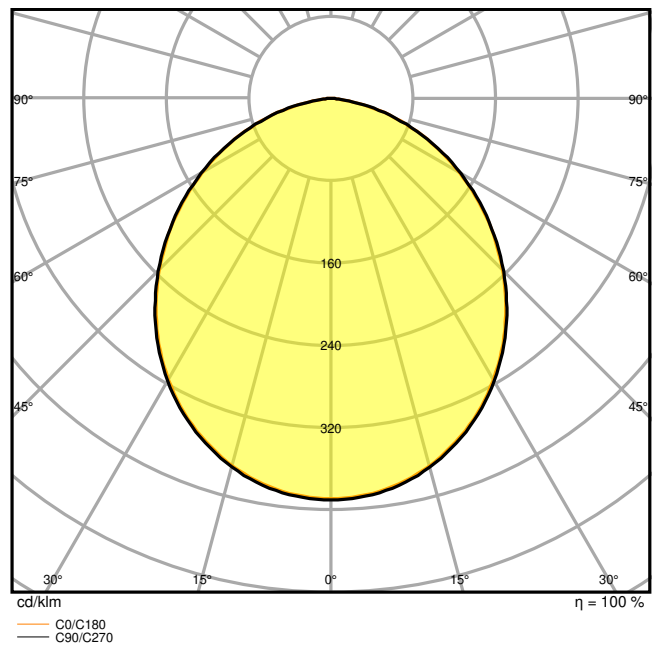

DL ALU DN200 35W 6500K WT EM AT 3H

Dimensions & Weight

Diameter	215.00 mm
Height	61.00 mm
Product weight	950.00 g

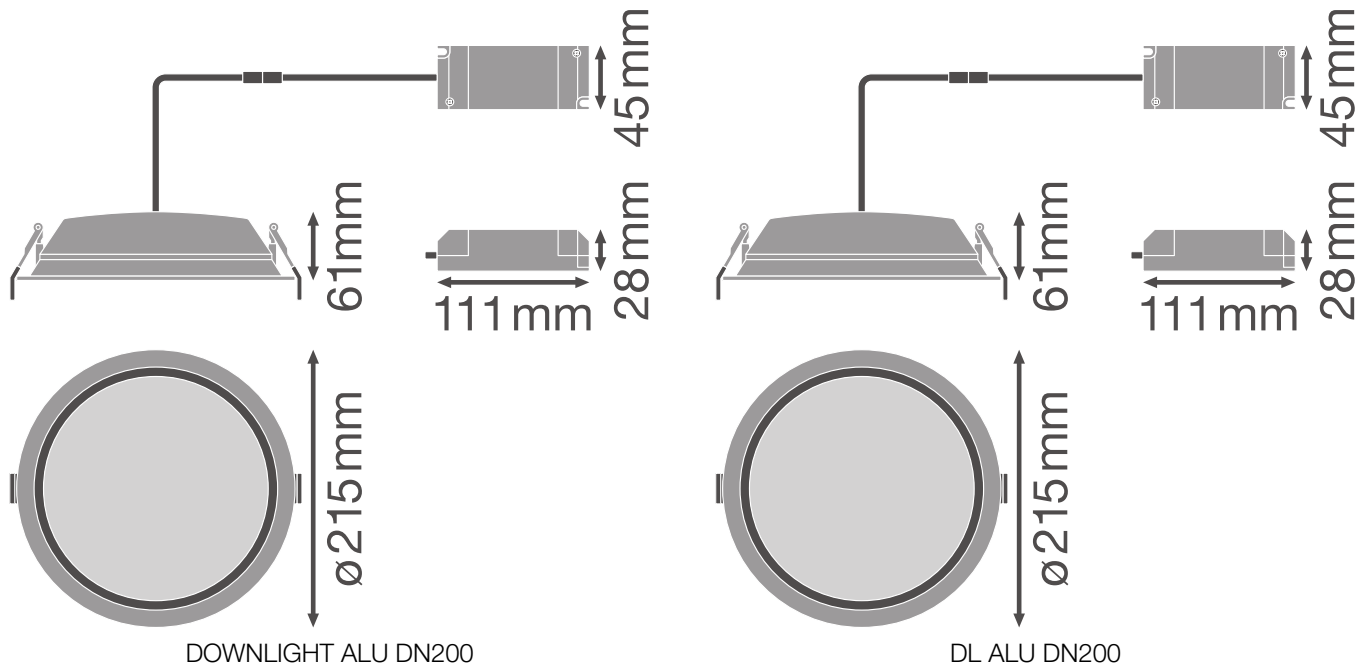

Materials & Colors

Product color	White
Housing color	White
Body material	Aluminum
Cover material	Polymethylmethacrylate (PMMA)
Glow Wire Test according to IEC 60695-2-12	650 °C
Mercury content	0.0 mg

Application & Mounting

Ambient temperature range	+5...+40 °C
Temperature range at storage	5...+35 °C
Type of connection	Screw terminal, 2-POLE (N, L. L switchable)
Type of protection	IP44/IP20
Protection class IK (shock resistance)	IK02
Dimmable	No
Mounting type	Recessed
Mounting location	Ceiling
Application environment	Indoor
Mounting diameter	200 mm

Mounting depth	120 mm
With light source	Yes

Lifespan

Lifespan L70/B50 at 25 °C	50000 h ¹⁾
Lifespan L80/B10 at 25 °C	45000 h ¹⁾
Lifespan L80/B50 at 25 °C	45000 h
Lifespan L90/B10 at 25 °C	30000 h
Number of switching cycles	100000

¹⁾ t[h]: L70 / B50 @ 25 °C (Ta), t[h]: L80 / B10 @ 25 °C (Ta), t[h]: L90 / B10 @ 25 °C (Ta)

Control gear

ECG - Length	138 mm
ECG - Width	45 mm
ECG - Height	28 mm

BATTERY

Type of Battery	LiFePO4
Battery size [GMS]	Others
Nominal voltage of battery	3.2 V
Nominal capacity of battery	4500 mAh
Battery charging time	< 24 h

Emergency lighting

Area of emergency application	Anti-panic lighting / Escape route lighting
Type of emergency light operation	Maintained / Non-maintained
Type of emergency operation test	Automatic
Wattage in maintained operation mode	35.0 W
Wattage in emergency operation mode	3,0 W
Luminous flux in maintained operation mode	3150 lm
Luminous flux in emergency operation mode	400 lm
Battery life in emergency operation mode	3 h
Integrated test switch	No

Certificates & Standards

Standards	CE / CB / EAC
Luminaire with limited surface temperature, "D sign"	No

Ball shot safe	No
Replaceable light source (EPREL)	Not replaceable



Additional product data







Number of illuminants	Not relevant
-----------------------	--------------



EQUIPMENT / ACCESSORIES

– Control LED with a retainer for recessed installation included

DOWNLOAD DATA

Documents and certificates		Document name
	User instruction / safety instructions	UI_Downlight_Alu_Emergency
	Declarations of conformity	EC declaration of EM downlight
	Certificates	EC declaration of EM downlight

Photometric and lighting design files		Document name
	IES file (IES)	DL ALU DN200 35W 6500K WT EM AT 3H
	LDT file (Eulumdat)	DL ALU DN200 35W 6500K WT EM AT 3H
	ULD file (DIALux)	DL ALU DN200 35W-6500K WT
	ROLF file (RELUX)	DL ALU DN200 35W-6500K
	UGR file (UGR table)	DL ALU DN200 35W 6500K WT EM AT 3H
	Light distribution curve type cone	DL ALU DN200 35W 6500K WT EM AT 3H
	Light distribution curve type polar	DL ALU DN200 35W 6500K WT EM AT 3H

CAD/BIM files		Document name
	BIM Revit 3D	Downlight ALU
	CAD STEP 3D	DL ALU 25W 35W

LOGISTICAL DATA

Product code	Packaging unit (Pieces/Unit)	Dimensions (length x width x height)	Gross weight	Volume
4058075204362	Folding box 1	322 mm x 222 mm x 114 mm	1115.00 g	8.15 dm ³
4058075204379	Shipping box 8	658 mm x 466 mm x 263 mm	6875.00 g	80.64 dm ³

The mentioned product code describes the smallest quantity unit which can be ordered. One shipping unit can contain one or more single products. When placing an order, for the quantity please enter single or multiples of a shipping unit.

References / Links

– For Guarantee see www.ledvance.com/guarantee

DISCLAIMER

Subject to change without notice. Errors and omission excepted. Always make sure to use the most recent release.