

Smart Sensor 2D Measurement Type ZS-N

CSM_ZS-N_DS_E_7_1

A Lineup for Ultra-high-precision Displacement Measurements That Take Smart Sensors into a New Realm



- ZS-HL Series
Ultra-high-performance Sensors for core quality for everything from ultra-long ranges to ultra-high precision.
- ZS-L Series
Standard Sensors that are ideal for a wide range of high-precision displacement measurements, including spot detection, wide-area detection, and long-distance detection.



For the most recent information on models that have been certified for safety standards, refer to your OMRON website.

Be sure to read "Safety Precautions" on page 20.

Features

ZS-HL Series

Very High-performance Sensors that Support Core Quality from Very Long-range to Extremely Precise Measurements

- Range of models with measuring center distance of 20 to 1,500 mm.
- Achieves maximum resolution of 0.25 μm .
- Maximum response speed of 110 μs .
- Parallel output supported.

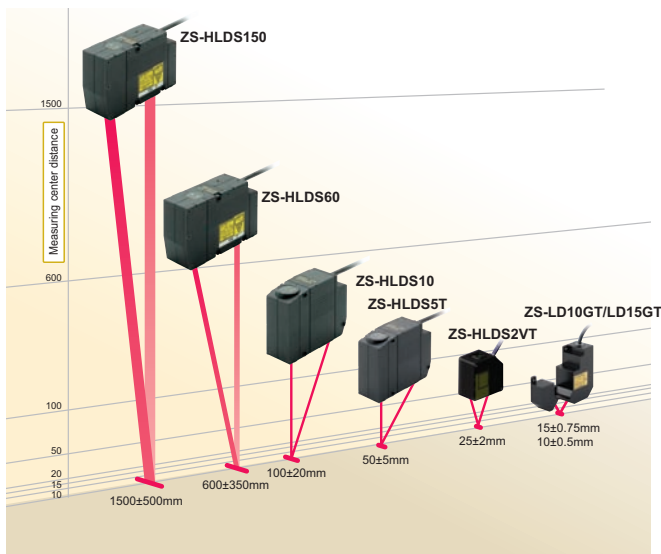

ZS-L Series

Standard Sensors Most Suitable for a Variety of High-precision Displacement Measurements, Including Spot Detection, Wide-range Detection, and Long-distance Detection.

- Beam Shapes
Spot and line beam selection.
- Wide Range of Products
Long-range, middle-range, and short-range models.

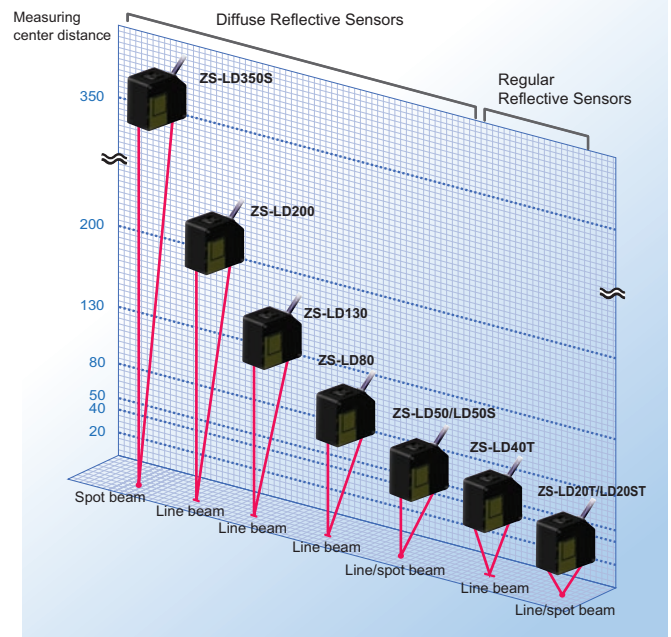

System Configuration

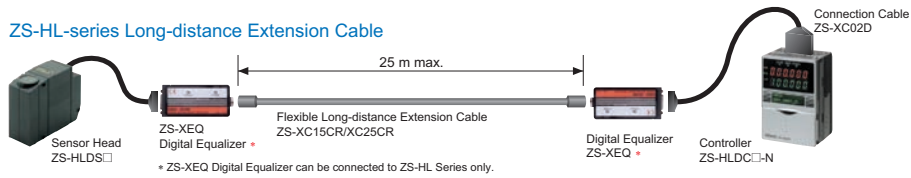
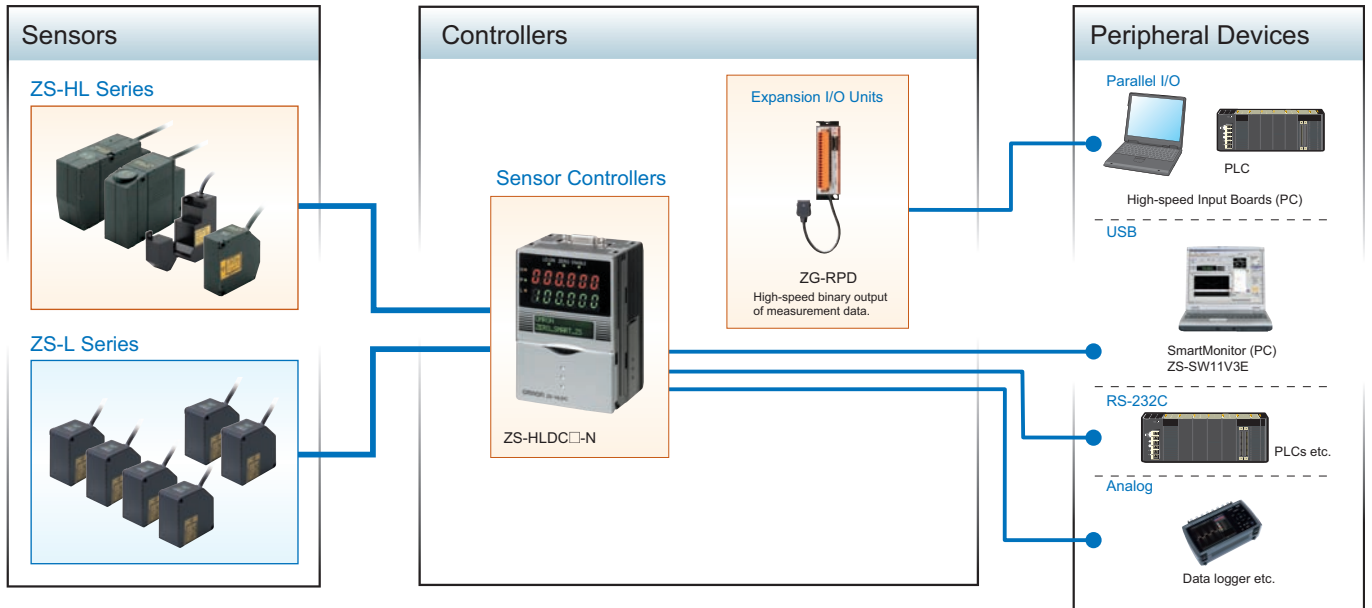

Ordering Information

Smart Sensor

ZS-HL series Sensor Heads

Optical system	Sensing distance	Beam shape	Beam diameter	Resolution (see note)	Cable length	Model
Regular Reflective Models	25±2 mm	Line beam	2.2 mm × 45 μm	0.6 μm	2m	ZS-HLDS2VT 2M
					0.5m	ZS-HLDS2VT 0.5M
Diffuse Reflective Models	50±5 mm	Line beam	1.0 mm × 0 μm	0.25 μm	2m	ZS-HLDS5T 2M
					0.5m	ZS-HLDS5T 0.5M
	100±20 mm	Line beam	3.5 mm × 60 μm	1 μm	2m	ZS-HLDS10 2M
					0.5m	ZS-HLDS10 0.5M
	600±350 mm	Line beam	16 mm × 0.3 mm	8 μm	2m	ZS-HLDS60 2M
					0.5m	ZS-HLDS60 0.5M
	1500±500 mm	Line beam	40 mm × 1.5 mm	500 μm	2m	ZS-HLDS150 2M
					0.5m	ZS-HLDS150 0.5M

Note: Refer to the table of ratings and specifications for details.

ZS-HL series Sensor Heads (For Nozzle Gaps)

Optical system	Sensing distance	Beam shape	Beam diameter	Resolution (see note)	Cable length	Model
Regular Reflective Models	10±0.5 mm	Line beam	900 × 25 μm	0.25 μm	2m	ZS-LD10GT 2M
					0.5m	ZS-LD10GT 0.5M
	15±0.75 mm	Line beam	900 × 25 μm	0.25 μm	2m	ZS-LD15GT 2M
					0.5m	ZS-LD15GT 0.5M

Note: Refer to the table of ratings and specifications for details.

ZS-L series Sensor Heads

Optical system	Sensing distance	Beam shape	Beam diameter	Resolution (see note)	Cable length	Model
Regular Reflective Models	20±1 mm	Line beam	900 × 25 μm	0.25 μm	2m	ZS-LD20T 2M
		Spot beam	25 μm dia.	0.25 μm	0.5m	ZS-LD20T 0.5M
	40±2.5 mm	Line beam	2000 × 35 μm	0.4 μm	2m	ZS-LD20ST 2M
					0.5m	ZS-LD20ST 0.5M
Diffuse Reflective Models	50±5 mm	Line beam	900 × 60 μm	0.8 μm	2m	ZS-LD40T 2M
					0.5m	ZS-LD40T 0.5M
		Spot beam	50 μm dia.	0.8 μm	2m	ZS-LD50 2M
					0.5m	ZS-LD50 0.5M
	80±15 mm	Line beam	900 × 60 μm	2 μm	2m	ZS-LD50S 2M
					0.5m	ZS-LD50S 0.5M
	130±15 mm	Line beam	600 × 70 μm	3 μm	2m	ZS-LD80 2M
					0.5m	ZS-LD80 0.5M
	200±50 mm	Line beam	900 × 100 μm	5 μm	2m	ZS-LD130 2M
					0.5m	ZS-LD130 0.5M
	350±135 mm	Spot beam	240 μm dia.	20 μm	2m	ZS-LD200 2M
					0.5m	ZS-LD200 0.5M
350±135 mm	Spot beam	240 μm dia.	20 μm	2m	ZS-LD350S 2M	
				0.5m	ZS-LD350S 0.5M	



Note: No. of samples to average: 128 when set to High-precision Mode.

ZS-HL series Sensor Controllers

Shape	Supply voltage	Control outputs	Model
	24 VDC	NPN outputs	ZS-HLDC11-N
		PNP outputs	ZS-HLDC41-N

Accessories (Sold Separately)

Panel Mount Adapter

Shape	Model	
	ZS-XPM1	For 1st Controller
	ZS-XPM2	For expansion (from 2nd Controller on)

RS-232C Cables

Connected to	Model	Qty
Personal computer (2 m)	ZS-XRS3	1
PLC/PT (2 m)	ZS-XPT3	

Extension Cables for Sensor Heads

Cable length	Model	Qty
1 m	ZS-XC1A	1
4 m	ZS-XC4A	
5 m	ZS-XC5B (*1,*2)	
8 m	ZS-XC8A	
10 m	ZS-XC10B (*1)	

*1 Up to two ZS-XC□B Cables can be connected. (22 m max.)

*2 The ZS-XC3BR (3 m) and ZS-XC5BR (5 m) Robot Cables are also available.

Long Extension Cables for Sensor Heads (Used with a Digital Equalizer for ZS-HL Series)

Name	Model	Qty
Digital Equalizer (Relay)	ZS-XEQ	1
Extension Cable (long distance, flexible 15 m cable)	ZS-XC15CR	1
Extension Cable (long distance, flexible 25 m cable)	ZS-XC25CR	1
Digital Equalizer Connection Cable (0.2 m)	ZS-XC02D	1

Logging Software

Name	Model
SmartMonitor Professional	ZS-SW11V3E

Realtime Parallel Output Unit (for ZS-HL Series)

Shape	Control outputs	Model
	NPN outputs	ZG-RPD11-N
	PNP outputs	ZG-RPD41-N

Memory Cards

Model	Capacity
HMC-EF283	256 MB
HMC-EF583	512 MB

Quick Reference for Extension Cable Connections

Extension Cable			Sensor Head		Controller	Remarks
Model	Length	Bend resistant	ZS-LD□ ZS-HLDS2V	-HLDS5/-HLDS10/ -HLDS60/-HLDS150	ZS-HLDC□-N	
ZS-XC1A	1m		✓	✓	✓	Only one Extension Cable can be used.
ZS-XC4A	4m		✓	✓	✓	
ZS-XC8A	8m		✓	✓	✓	
ZS-XC5B	5m		✓	✓	✓	Up to two Extension Cables can be used. (The maximum length is 22 m.)
ZS-XC10B	10m		✓	✓	✓	
ZS-XC5BR	5m	✓	✓	✓	✓	A ZS-XEQ Digital Equalizer and ZS-XC02D Digital Equalizer Connecting Cable are required.
ZS-XC15CR	15m	✓		✓	✓	
ZS-XC25CR	25m	✓		✓	✓	

Ratings and Specifications

Sensor Controllers

Item	Model	ZS-HLDC11-N	ZS-HLDC41-N	
No. of samples to average		1, 2, 4, 8, 16, 32, 64, 128, 256, 512, 1,024, 2,048, or 4,096		
Number of mounted Sensors		1 per Sensor Controller		
External interface	Connection method		Serial I/O: connector, Other: pre-wired (Standard cable length: 2 m)	
	Serial I/O	USB 2.0	1 port, Full Speed (12 Mbps max.), MINI-B	
		RS-232C	1 port, 115,200 bps max.	
	Output	Judgment output	HIGH/PASS/LOW 3 outputs NPN open collector, 30 VDC, 50 mA max., residual voltage 1.2 V max.	HIGH/PASS/LOW: 3 outputs PNP open collector, 50 mA max., residual voltage 1.2 V max.
		Linear output	Selectable from 2 types of output, voltage or current (selected by slide switch on bottom). • Voltage output: -10 to 10 V, output impedance: 40 • Current output: 4 to 20 mA, maximum load resistance: 300	
Inputs	Laser OFF, ZERO reset timing, RESET	ON: Short-circuited with 0 V terminal or 1.5 V or less OFF: Open (leakage current: 0.1 mA max.)	ON: Short-circuited to supply voltage or within 1.5 V of supply voltage. OFF: Open (leakage current: 0.1 mA max.)	
Functions		Display: Measured value, threshold value, voltage/current, received light amount, and resolution/terminal block output Sensing: Mode, gain, measurement object, head installation Measurement point: Average, peak, bottom, thickness, step, and calculations Filter: Smooth, average, and differentiation Outputs: Scaling, various hold values, and zero reset I/O settings: Linear (focus/correction), judgments (hysteresis and timer), non-measurement, and bank (switching and clear) System: Save, initialization, measurement information display, communications settings, key lock, language, and data load Task: Single task or multitask (up to 4)		
Status indicators		HIGH (orange), PASS (green), LOW (orange), LDON (green), ZERO (orange), and ENABLE (green)		
Segment display	Main digital	8-segment red LED, 6 digits		
	Sub-digital	8-segment green LEDs, 6 digits		
LCD		16 digits x 2 rows, Color of characters: green, Resolution per character: 5 x 8 pixel matrix		
Setting	Setting keys	Direction keys (UP, DOWN, LEFT, and RIGHT), SET key, ESC key, MENU key, and function keys (1 to 4)		
	Slide switch	Threshold switch (2 states: High/Low), mode switch (3 states: FUN, TEACH, and RUN)		
Power supply voltage		21.6 V to 26.4 VDC (including ripple)		
Current consumption		0.5 A max. (when Sensor Head is connected)		
Ambient temperature		Operating: 0 to 50°C, Storage: -15 to +60°C (with no icing or condensation)		
Ambient humidity		Operating and storage: 35% to 85% (with no condensation)		
Degree of protection		IP20 (IEC60529)		
Materials		Case: Polycarbonate (PC)		
Cable length		2 m		
Weight		Approx. 280 g (excluding packing materials and accessories)		
Accessories		Ferrite core (1), instruction sheet		

ZS-HL series Sensor Heads

Item	Model	ZS-HLDS2VT	ZS-HLDS5T	ZS-HLDS10	ZS-HLDS60	ZS-HLDS150
Optical system		Regular reflection	Diffuse reflection Regular reflection	Diffuse reflection Regular reflection	Diffuse reflection	Diffuse reflection
Measuring center distance		25 mm	50 mm 44 mm	100 mm 94 mm	600 mm	1,500 mm
Measuring range		±2 mm	±5 mm ±4 mm	±20 mm ±16 mm	±350 mm	±500 mm
Light source	Visible semiconductor laser (wavelength: 650 nm, 1 mW max., JIS Class 2)					
Beam shape	Line beam					
Beam diameter *1		2.2mm × 45 μm	1.0mm × 30 μm	3.5mm × 60 μm	16 × 0.3 mm (at 500 mm)	40 × 1.5 mm (at 1,500 mm)
Linearity *2		±0.2% F.S.	±0.1% F.S.		±0.07% F.S. (250 to 750 mm) ±0.1% F.S. (750 to 950 mm)	±0.2% F.S.
Resolution *3		0.6 μm (No. of samples to average: 128)	0.25 μm (No. of samples to average: 512)	1 μm (No. of samples to average: 64)	8 μm (No. of samples to average: 64 at 250 mm), 40 μm (No. of samples to average: 64 at 600 mm)	500 μm (No. of samples to average: 64)
Temperature characteristic *4		±0.1% F.S./°C	0.01% F.S./°C			
Sampling cycle	110 μs (High-speed Mode), 500 μs (Standard Mode), 2.2 ms (High-precision Mode), 4.4 ms (High-sensitivity Mode)					
LED Indicators	NEAR indicator	Lights near the measuring center distance, and closer than the measuring center distance inside the measuring range. Flashes when the measurement target is outside of the measuring range or when the received light amount is insufficient.				
	FAR indicator	Lights near the measuring center distance, and farther than the measuring center distance inside the measuring range. Flashes when the measurement target is outside of the measuring range or when the received light amount is insufficient.				
Operating ambient illumination		Illumination on received light surface: 3000 lx or less (incandescent light)			Illumination on received light surface: 1000 lx or less (incandescent light)	Illumination on received light surface: 500 lx or less (incandescent light)
Ambient temperature	Operating: 0 to 50°C, Storage: -15 to 60°C (with no icing or condensation)					
Ambient humidity	Operating and storage: 35% to 85% (with no condensation)					
Degree of protection *5		IP67	Cable length 0.5 m: IP66, cable length 2 m: IP67		IP66 *6	
Materials	Case: Aluminum die-cast, Front cover: Glass					
Cable length		2 m	0.5 m, 2 m			
Weight		Approx. 350 g	Approx. 600 g		Approx. 800 g	
Accessories	ZS-HLDS2VT: Laser labels (1 each for JIS/EN), ferrite cores (2), insure locks (2), instruction sheet ZS-HLDS5T/-HLDS10/-HLDS60/-HLDS150: Laser labels (1 each for JIS/EN, 3 for FDA), ferrite cores (4), insure locks (2), instruction sheet					

*1 Defined as 1/e² (13.5%) of the center optical intensity at the actual measuring center distance (effective value).

The beam diameter is sometimes influenced by the ambient conditions of the workpiece, such as leaked light from the main beam.

*2 This is the error in the measured value with respect to an ideal straight line. Linearity may change according to the workpiece. The following options are available.

Model	Diffuse reflection	Mirror reflection
ZS-HLDS2VT	---	Glass
ZS-HLDS5T	White alumina ceramic	Glass
ZS-HLDS10	White alumina ceramic	
ZS-HLDS60/HLDS150	White alumina ceramic	---

*3 This is the peak-to-peak displacement conversion value in the displacement output at the measuring center distance in high-precision mode when the number of samples to average is set to within the graph. The maximum resolution at 250 mm is also shown for the ZS-HLDS60. The following options are available.

Model	Diffuse reflection	Mirror reflection
ZS-HLDS2VT	---	Glass
ZS-HLDS5T	White alumina ceramic	Glass
ZS-HLDS10	White alumina ceramic	
ZS-HLDS60/HLDS150	White alumina ceramic	---

*4 This is the value obtained at the measuring center distance when the Sensor and workpiece are fixed by an aluminum jig. (typical example)

*5 Protection structure of connector area is IP40.

*6 Ask your OMRON representative about Sensor Heads with IP67 protection.

ZS-L series Sensor Heads

Item	Model	ZS-LD20T		ZS-LD20ST		ZS-LD40T		ZS-LD10GT	ZS-LD15GT
Optical system		Regular reflection	Diffuse reflection	Regular reflection	Diffuse reflection	Regular reflection	Diffuse reflection	Regular reflection	
Measuring center distance		20 mm	6.3 mm	20 mm	6.3 mm	40 mm	30 mm	10 mm	15 mm
Measuring range		±1 mm	±1 mm	±1 mm	±1 mm	±2.5 mm	±2 mm	±0.5 mm	±0.75 mm
Light source		Visible semiconductor laser (wavelength: 650 nm, 1 mW max., JIS Class 2)							
Beam shape		Line beam		Spot beam		Line beam			
Beam diameter *1		900 × 25 μm		25 μm dia.		2,000 × 35 μm		Approx. 25 × 900 μm	
Linearity *2		±0.1% F.S.							
Resolution *3		0.25 μm		0.25 μm		0.4 μm		0.25 μm	0.25 μm
Temperature characteristic *4		0.04% F.S./°C		0.04% F.S./°C		0.02% F.S./°C		0.04% F.S./°C	
Sampling cycle		110 μs (High-speed Mode), 500 μs (Standard Mode), 2.2 ms (High-precision Mode), 4.4 ms (High-sensitivity Mode)							
LED Indicators	NEAR indicator	Lights near the measuring center distance, and closer than the measuring center distance inside the measuring range. Flashes when the measurement target is outside of the measuring range or when the received light amount is insufficient.							
	FAR indicator	Lights near the measuring center distance, and farther than the measuring center distance inside the measuring range. Flashes when the measurement target is outside of the measuring range or when the received light amount is insufficient.							
Operating ambient illumination		Illumination on received light surface: 3000 lx or less (incandescent light)							
Ambient temperature		Operating: 0 to 50°C, Storage: -15 to 60°C (with no icing or condensation)							
Ambient humidity		Operating and storage: 35% to 85% (with no condensation)							
Degree of protection *5		Cable length 0.5 m: IP66, cable length 2 m: IP67						IP40	
Materials		Case: Aluminum die-cast, Front cover: Glass							
Cable length		0.5 m, 2 m							
Weight		Approx. 350 g						Approx. 400 g	
Accessories		Laser labels (1 each for JIS/EN, 3 for FDA), ferrite cores (2), insure locks (2), instruction sheet						Laser safety labels (1 each for JIS/EN), ferrite cores (2), insure locks (2)	

*1 Defined as $1/e^2$ (13.5%) of the center optical intensity at the actual measuring center distance (effective value). The beam diameter is sometimes influenced by the ambient conditions of the workpiece, such as leaked light from the main beam.

*2 This is the error in the measured value with respect to an ideal straight line. The standard workpiece is white aluminum ceramics and glass in the regular reflection mode. Linearity may change according to the workpiece.

*3 This is the peak-to-peak displacement conversion value in the displacement output at the measuring center distance in high-precision mode when the number of samples to average is set to 128 and the measuring mode is set to the high-resolution mode. The standard workpiece is white aluminum ceramics and glass in the regular reflection mode.

*4 This is the value obtained at the measuring center distance when the Sensor and workpiece are fixed by an aluminum jig. (typical example)

*5 Protection structure of connector area is IP40.

ZS-L series Sensor Heads

Item	Model	ZS-LD50		ZS-LD50S		ZS-LD80		ZS-LD130		ZS-LD200		ZS-LD350S	
Optical system		Diffuse reflection	Regular reflection	Diffuse reflection	Regular reflection	Diffuse reflection	Regular reflection	Diffuse reflection	Regular reflection	Diffuse reflection	Regular reflection	Diffuse reflection	
Measuring center distance		50 mm	47 mm	50 mm	47 mm	80 mm	78 mm	130 mm	130 mm	200 mm	200 mm	350 mm	
Measuring range		±5 mm	±4 mm	±5 mm	±4 mm	±15 mm	±14 mm	±15 mm	±12 mm	±50 mm	±48 mm	±135 mm	
Light source		Visible semiconductor laser (wavelength: 650 nm, 1 mW max., JIS Class 2)											
Beam shape		Line beam		Spot beam		Line beam		Line beam		Line beam		Spot beam	
Beam diameter *1		900 × 60 μm		50 μm dia.		900 × 60 μm		600 × 70 μm		900 × 100 μm		240 μm dia.	
Linearity *2		±0.1% F.S.							±0.25% F.S.	±0.1% F.S.	±0.25% F.S.	±0.1% F.S.	
Resolution *3		0.8 μm		0.8 μm		2 μm		3 μm		5 μm		20 μm	
Temperature characteristic *4		0.02% F.S./°C		0.02% F.S./°C		0.01% F.S./°C		0.02% F.S./°C		0.02% F.S./°C		0.04% F.S./°C	
Sampling cycle		110 μs (High-speed Mode), 500 μs (Standard Mode), 2.2 ms (High-precision Mode), 4.4 ms (High-sensitivity Mode)											
LED Indicators	NEAR indicator	Lights near the measuring center distance, and closer than the measuring center distance inside the measuring range. Flashes when the measurement target is outside of the measuring range or when the received light amount is insufficient.											
	FAR indicator	Lights near the measuring center distance, and farther than the measuring center distance inside the measuring range. Flashes when the measurement target is outside of the measuring range or when the received light amount is insufficient.											
Operating ambient illumination		Illumination on received light surface: 3000 lx or less (incandescent light)						Illumination on received light surface: 2000 lx or less (incandescent light)		Illumination on received light surface: 3000 lx or less (incandescent light)			
Ambient temperature		Operating: 0 to 50°C, Storage: -15 to 60°C (with no icing or condensation)											
Ambient humidity		Operating and storage: 35% to 85% (with no condensation)											
Degree of protection *5		Cable length 0.5 m: IP66, cable length 2 m: IP67											
Materials		Case: Aluminum die-cast, Front cover: Glass											
Cable length		0.5 m, 2 m											
Weight		Approx. 350g											
Accessories		Laser labels (1 each for JIS/EN, 3 for FDA), ferrite cores (2), insure locks (2), instruction sheet											

*1 Defined as 1/e² (13.5%) of the center optical intensity at the actual measuring center distance (effective value). The beam diameter is sometimes influenced by the ambient conditions of the workpiece, such as leaked light from the main beam.

*2 This is the error in the measured value with respect to an ideal straight line. The standard workpiece is white aluminum ceramics and glass in the ZS-LD50/LD50S regular reflection mode. Linearity may change according to the workpiece.

*3 This is the peak-to-peak displacement conversion value in the displacement output at the measuring center distance in high-precision mode when the number of samples to average is set to 128 and the measuring mode is set to the high-resolution mode. The standard workpiece is white aluminum ceramics and glass in the ZS-LD50/LD50S regular reflection mode.

*4 This is the value obtained at the measuring center distance when the Sensor and workpiece are fixed by an aluminum jig.

*5 Protection structure of connector area is IP40.

Engineering Data (Reference Value)

Linearity Characteristic by Materials

ZS-HLDS2VT (mode: High-Resolution)

Regular reflection

Inclination angle 0°

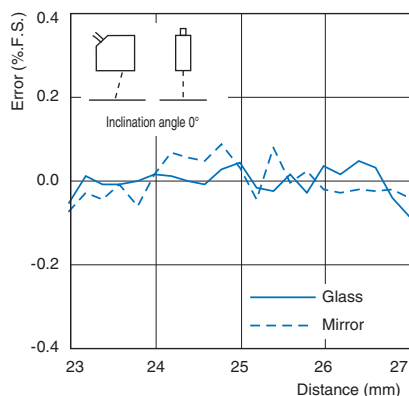

Inclination angle Vertical +0.5°

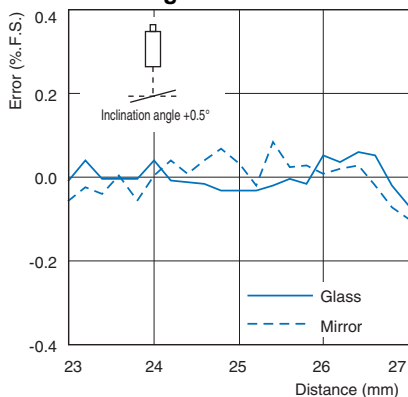

Inclination angle Vertical +1°

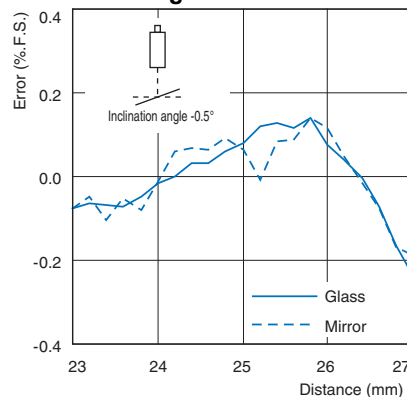

Inclination angle Vertical -0.5°

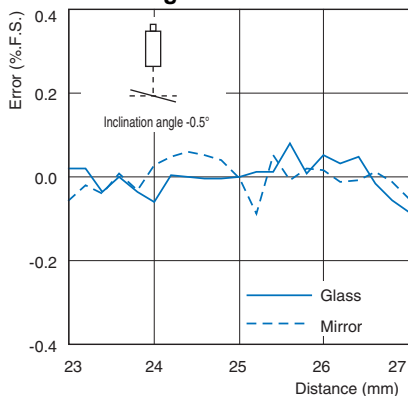

Inclination angle Vertical -1°

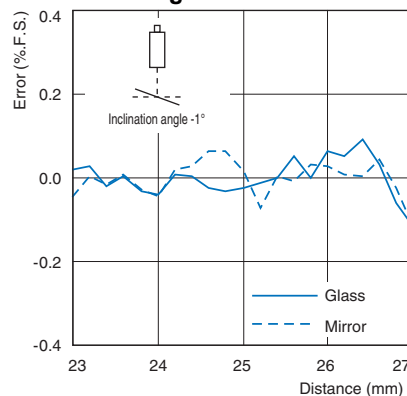

Inclination angle Horizontal +0.5°

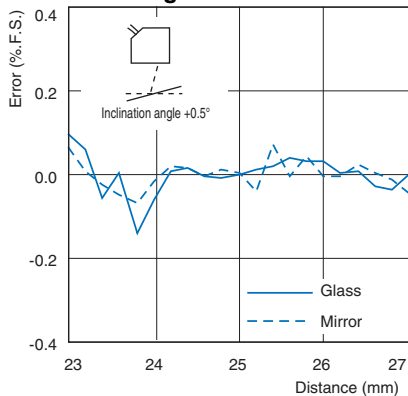

Inclination angle Horizontal +1°

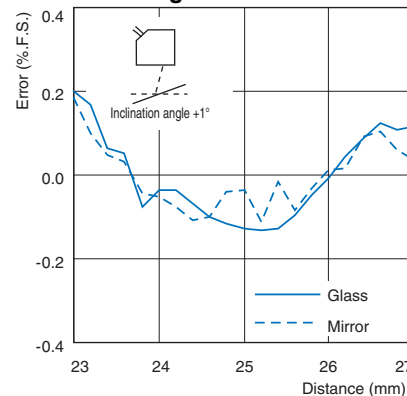

Inclination angle Horizontal -0.5°

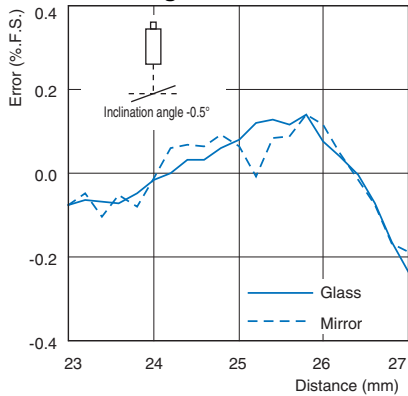

Inclination angle Horizontal -1°

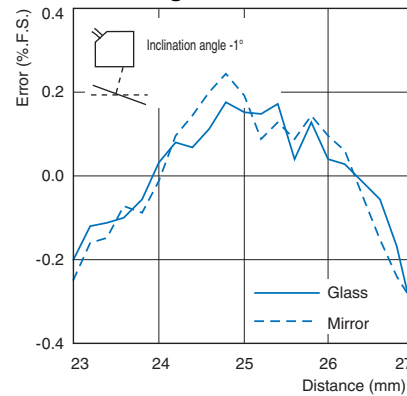

ZS-HLDS5T (mode: High-Resolution)

Diffuse reflection

Inclination angle 0°

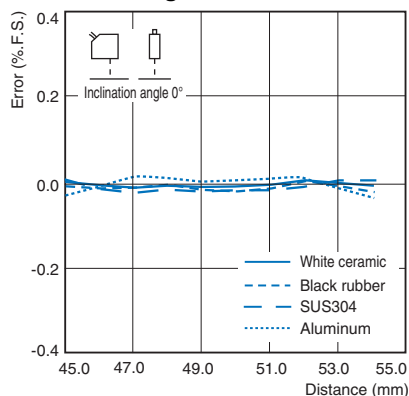

Inclination angle Vertical +45°

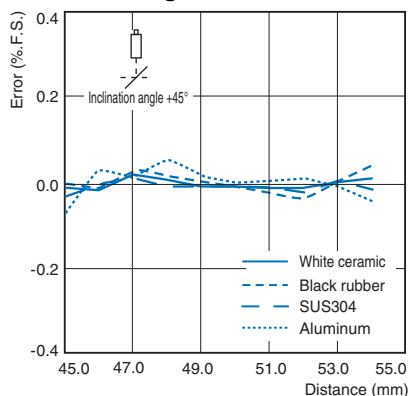

Inclination angle Horizontal +45°

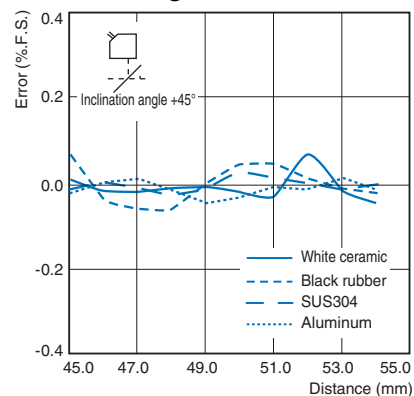

Inclination angle Vertical -45°

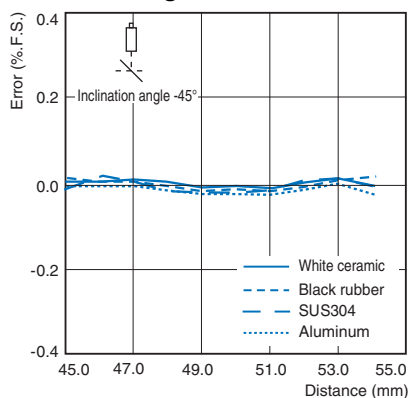

Inclination angle Horizontal -45°

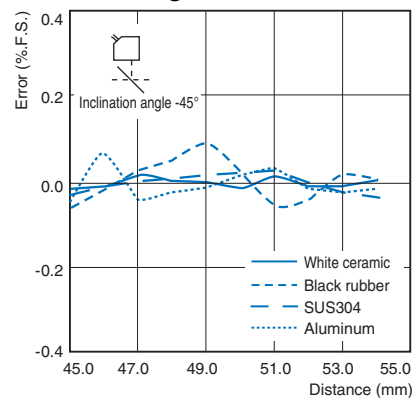

Regular reflection

Inclination angle 0°

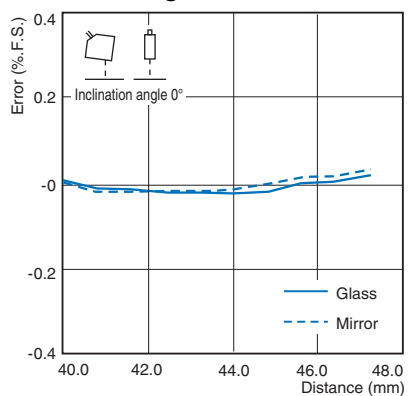

Inclination angle Vertical +0.5°

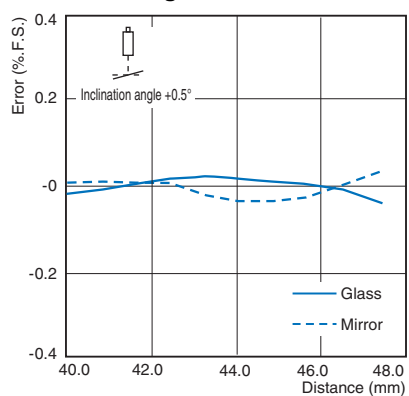

Inclination angle Horizontal +0.5°

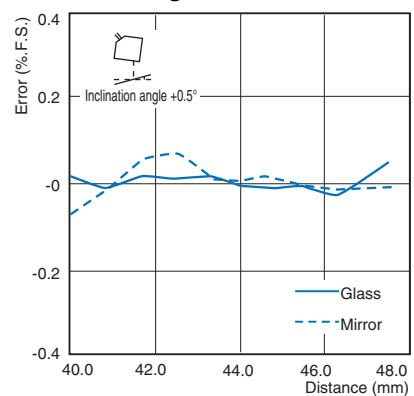

Inclination angle Vertical -0.5°

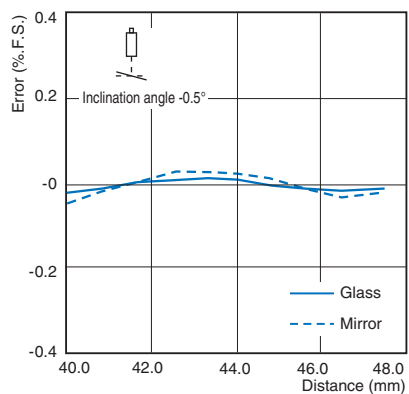

Inclination angle Horizontal -0.5°

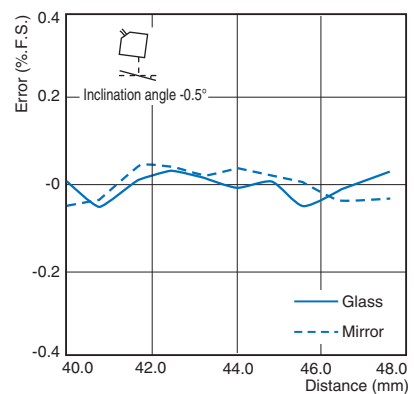

ZS-HLDS10 (mode: High-Resolution)

Diffuse reflection

Inclination angle 0°

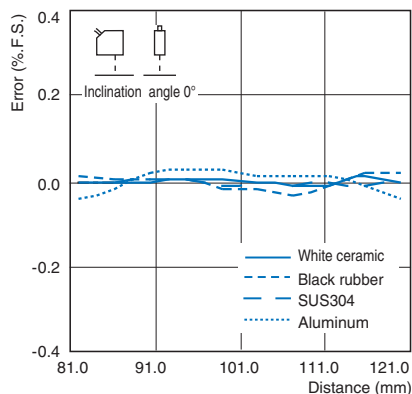

Inclination angle Vertical +45°

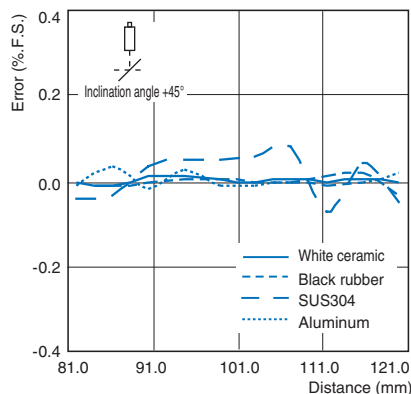

Inclination angle Horizontal +45°

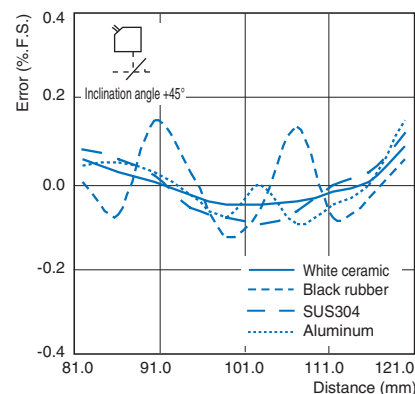

Inclination angle Vertical -45°

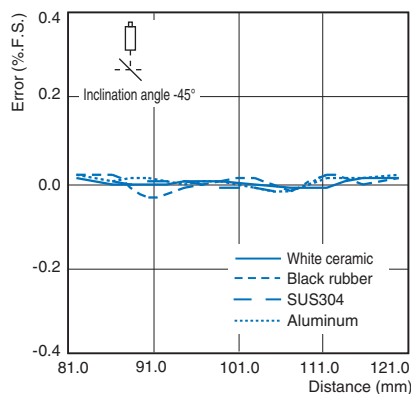

Inclination angle Horizontal -45°

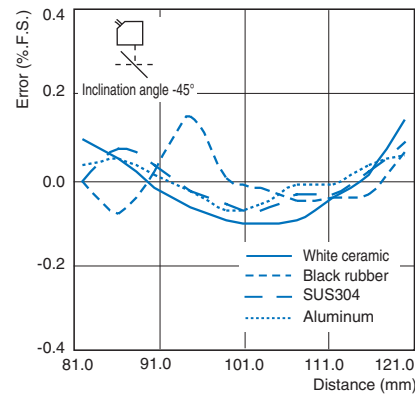

Regular reflection

Inclination angle 0°

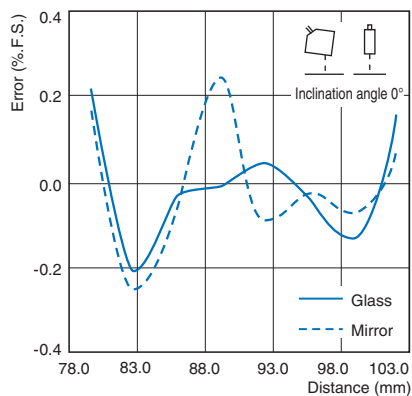

Inclination angle Vertical +0.5°

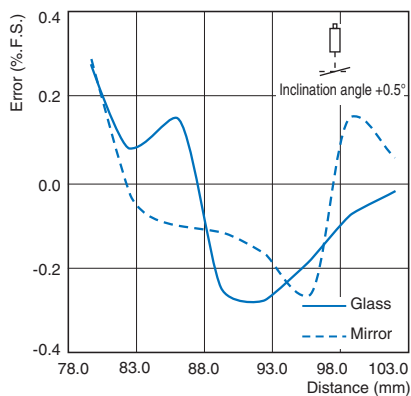

Inclination angle Horizontal +0.5°

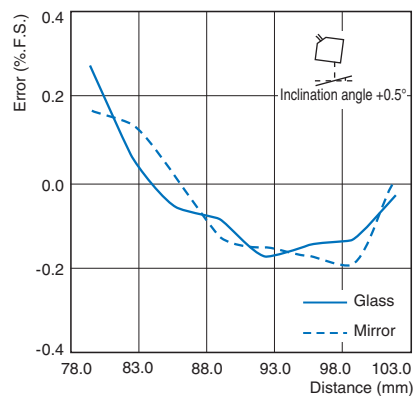

Inclination angle Vertical -0.5°

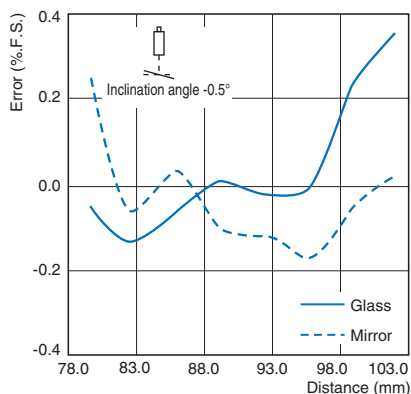

Inclination angle Horizontal -0.5°

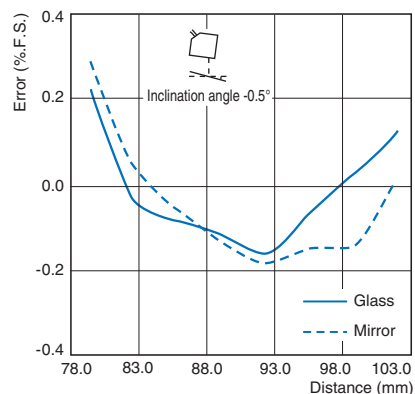

ZS-HLDS60 (mode: High-Resolution)

Diffuse reflection

Inclination angle 0°

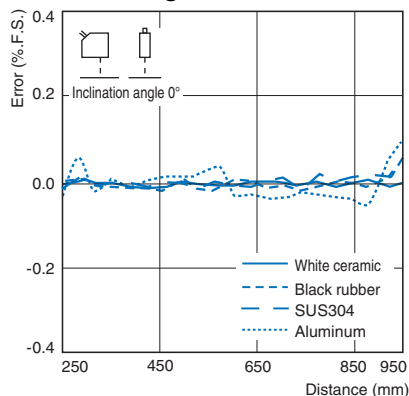

Inclination angle Vertical +45°

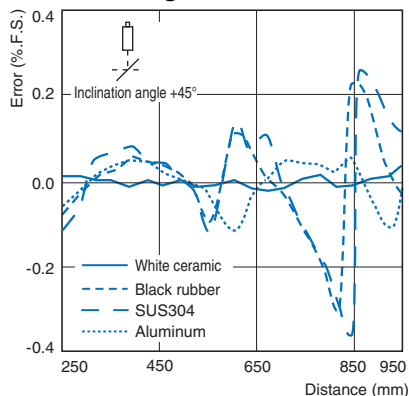

Inclination angle Horizontal +45°

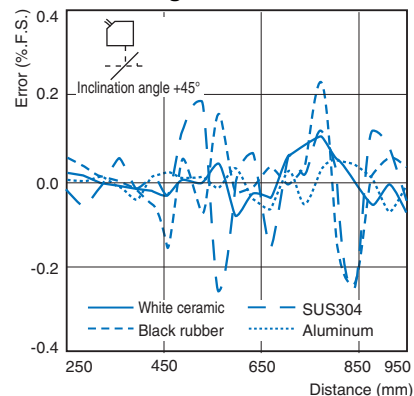

Inclination angle Vertical -45°

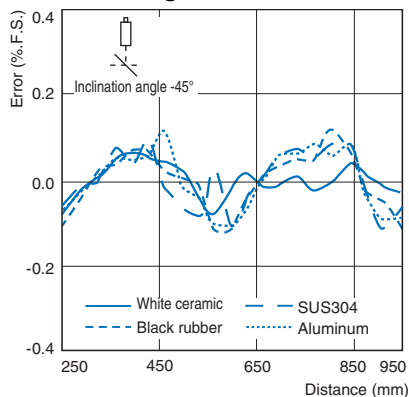

Inclination angle Horizontal -45°

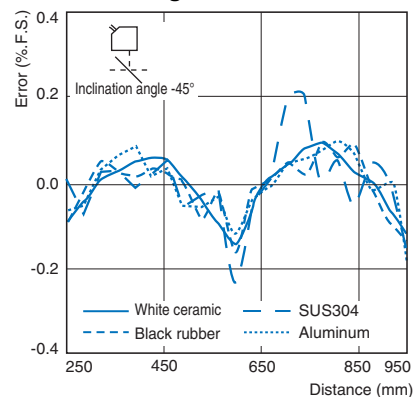

ZS-HLDS150 (mode: High-Resolution)

Diffuse reflection

Inclination angle 0°

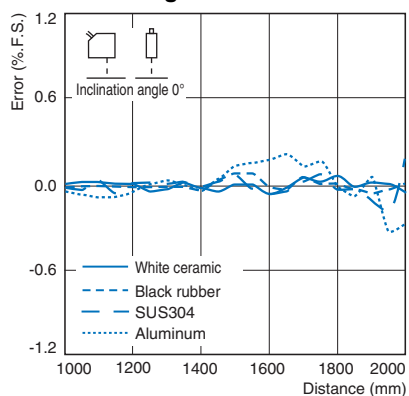

Inclination angle Vertical +45°

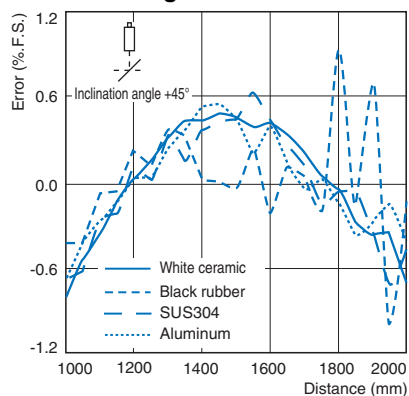

Inclination angle Horizontal +45°

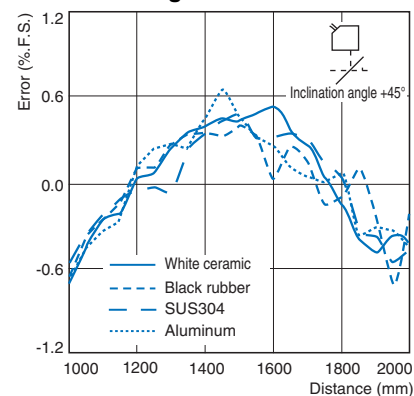

Inclination angle Vertical -45°

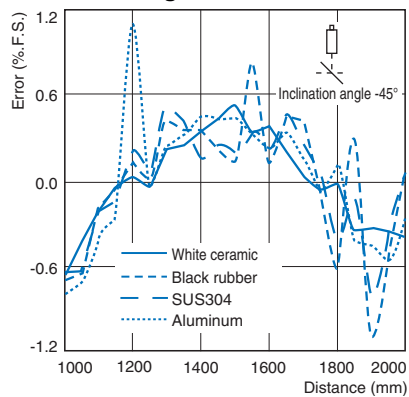

Inclination angle Horizontal -45°

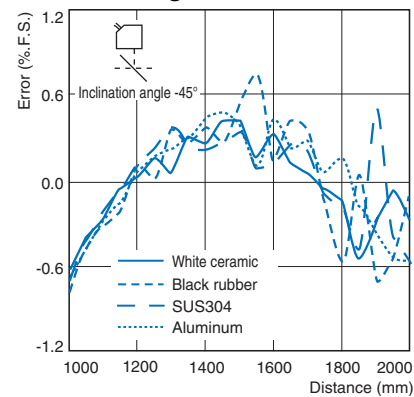

ZS-LD20T (mode: Standard)

Regular reflection

Inclination angle 0°

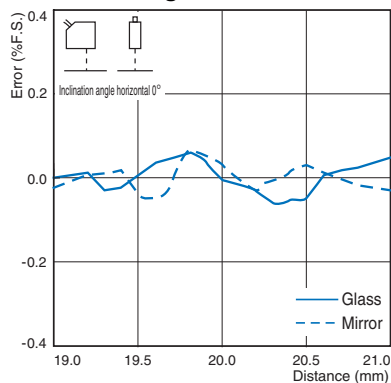

Inclination angle Horizontal +0.5°

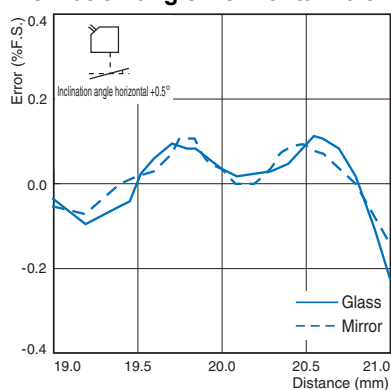

Inclination angle Horizontal -0.5°

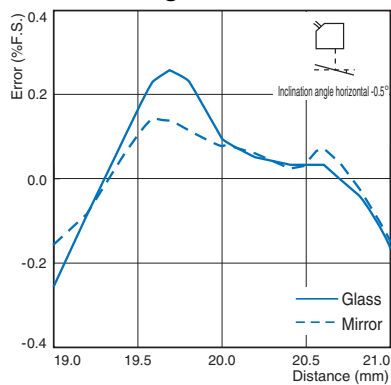

Inclination angle Vertical ±0.5°

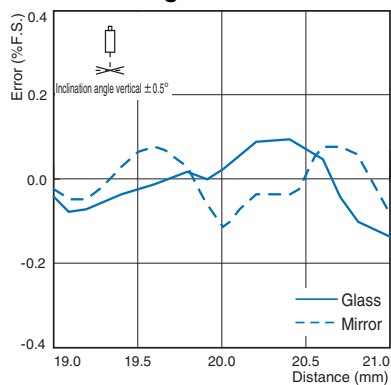

Diffuse reflection

Inclination angle 0°

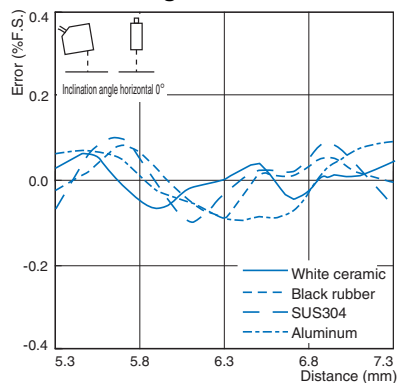

Inclination angle Horizontal +15°

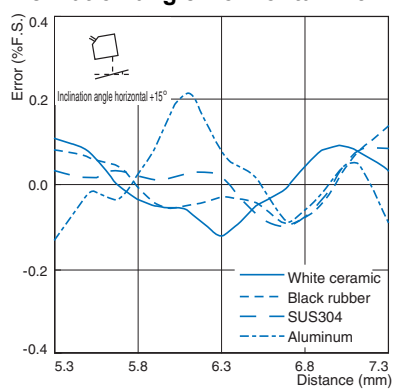

Inclination angle Horizontal -15°

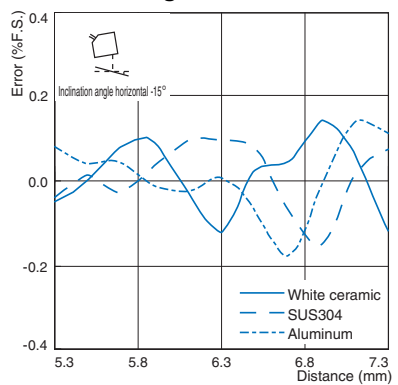

Inclination angle Vertical ±15°

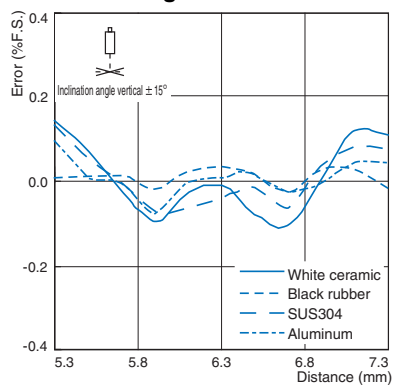

ZS-LD20ST (mode: Standard)

Regular reflection

Inclination angle 0°

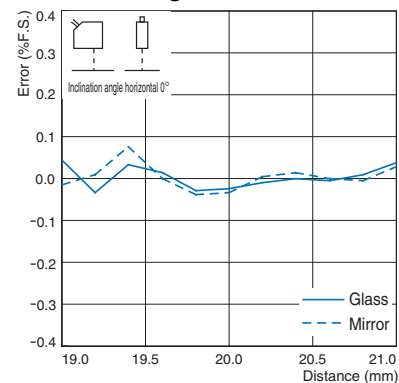

Inclination angle Horizontal +0.5°

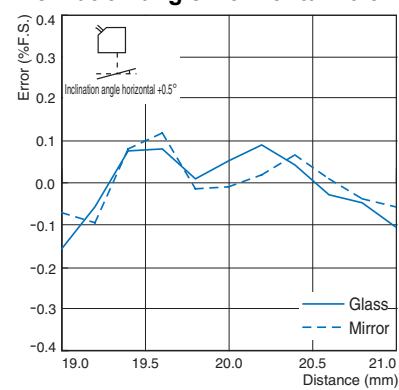

Inclination angle Horizontal -0.5°

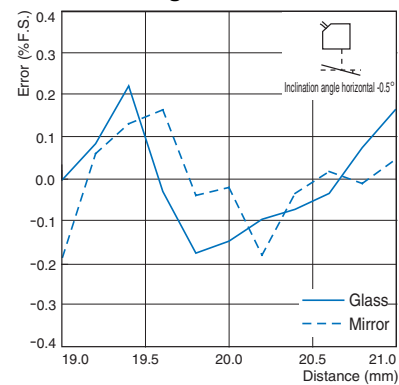

Inclination angle Vertical ±0.5°

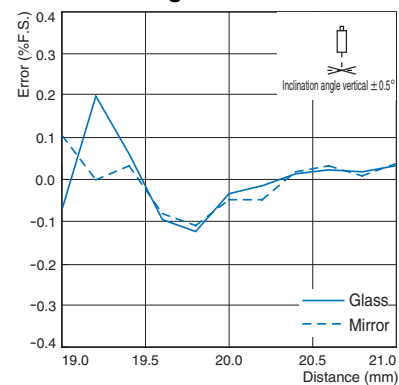

ZS-LD20ST (mode: Standard)

Diffuse reflection

Inclination angle 0°

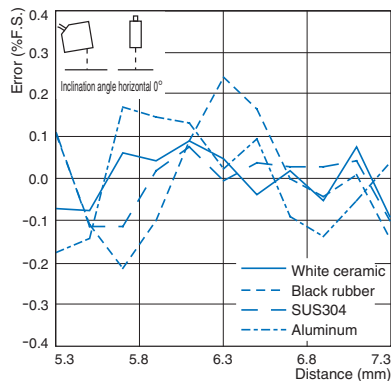

Inclination angle Horizontal +15°

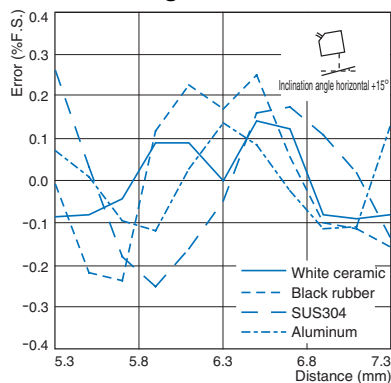

Inclination angle Horizontal -15°

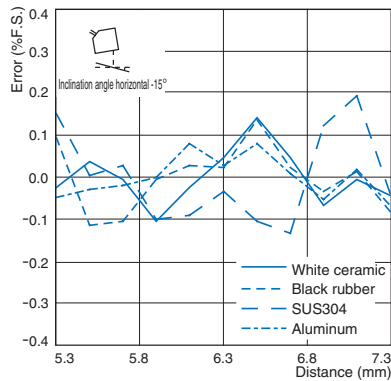

Inclination angle Vertical ±15°

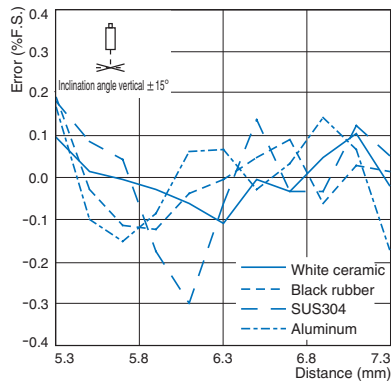

ZS-LD40T (mode: Standard)

Regular reflection

Inclination angle 0°

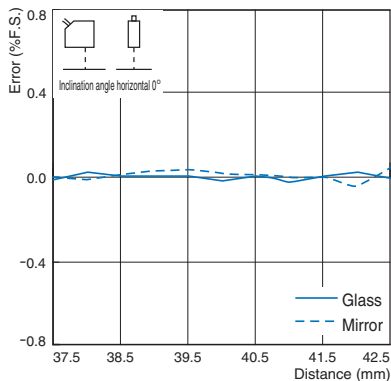

Inclination angle Horizontal +0.5°

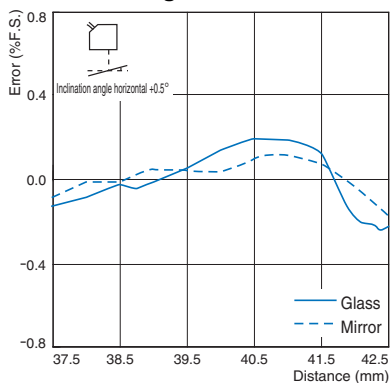

Inclination angle Horizontal -0.5°

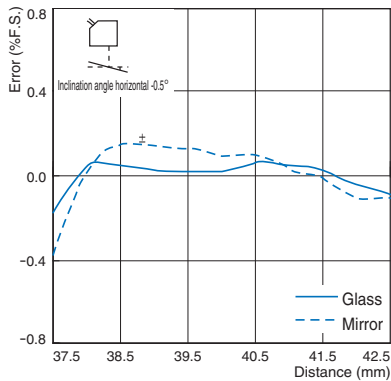

Inclination angle Vertical ±0.5°

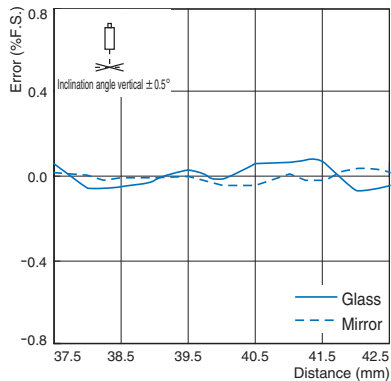

Diffuse reflection

Inclination angle 0°

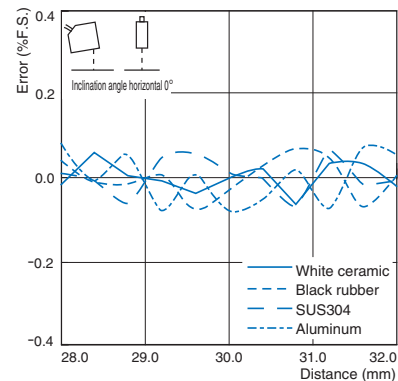

Inclination angle Horizontal +15°

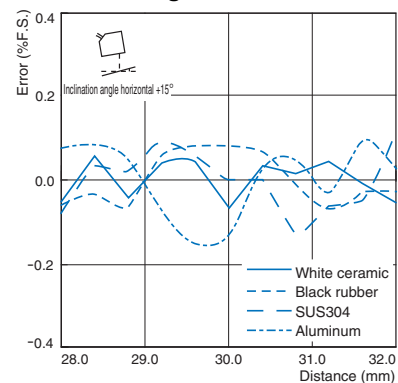

Inclination angle Horizontal -15°

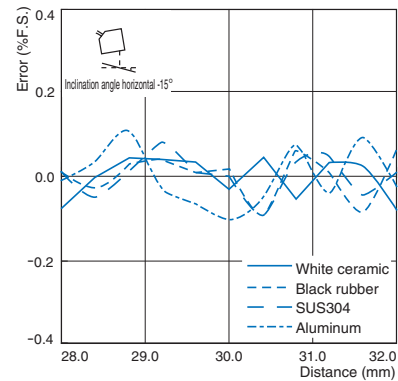

Inclination angle Vertical ±15°

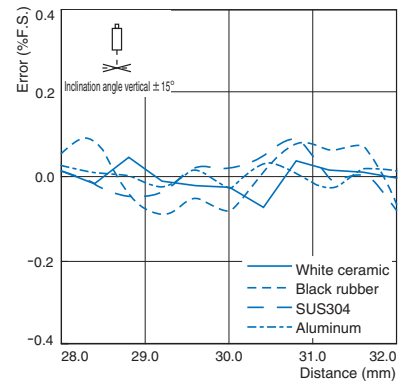

ZS-LD50 (mode: Standard)

Diffuse reflection

Inclination angle 0°

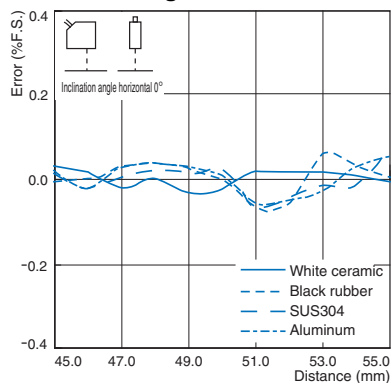

Inclination angle Horizontal +15°

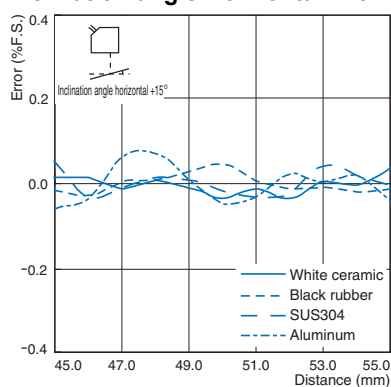

Inclination angle Horizontal -15°

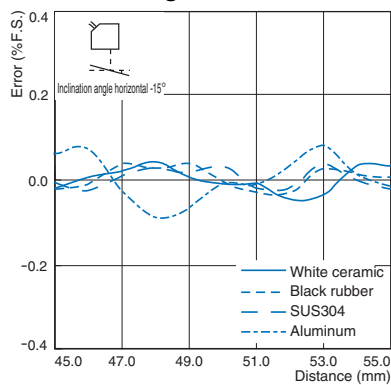

Inclination angle Vertical ±15°

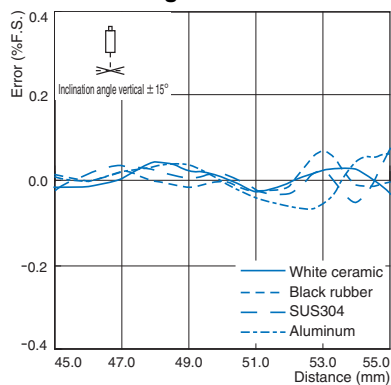

Regular reflection

Inclination angle 0°

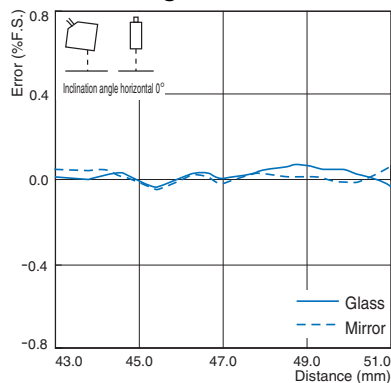

Inclination angle Horizontal +0.5°

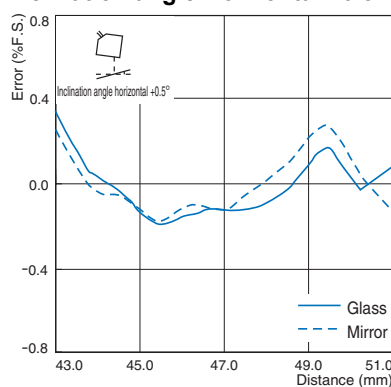

Inclination angle Horizontal -0.5°

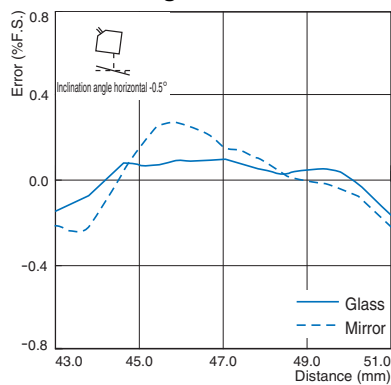

Inclination angle Vertical ±0.5°

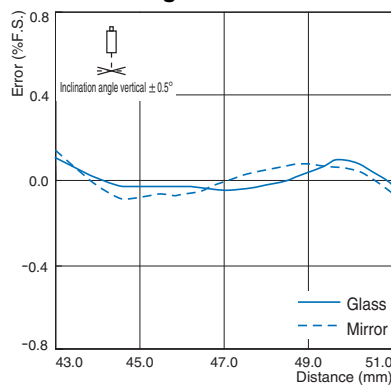

ZS-LD50S (mode: Standard)

Diffuse reflection

Inclination angle 0°

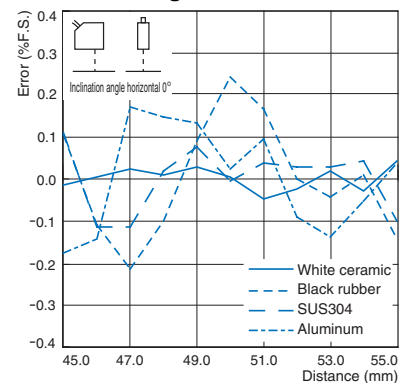

Inclination angle Horizontal +15°

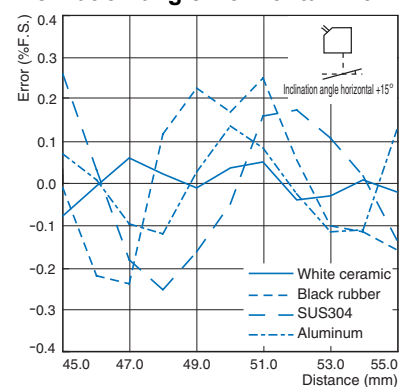

Inclination angle Horizontal -15°

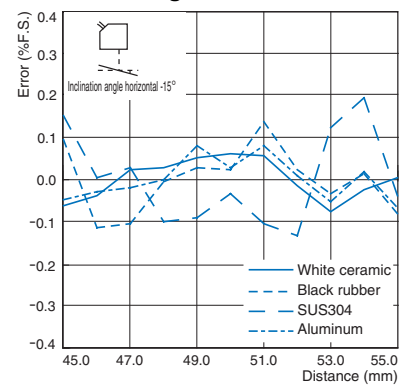

Inclination angle Vertical ±15°

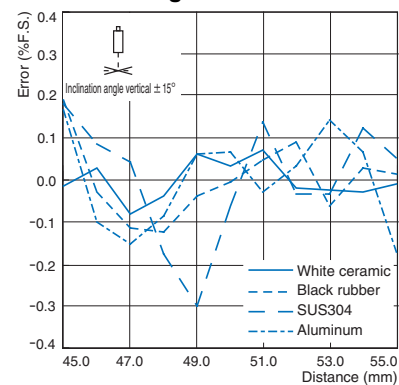

ZS-LD50S (mode: Standard)

Regular reflection

Inclination angle 0°

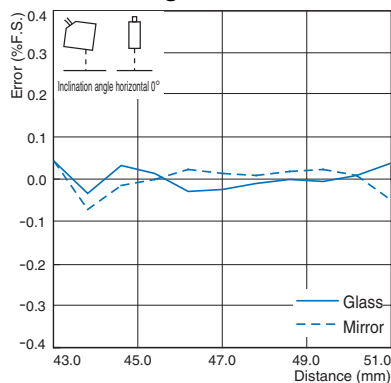

Inclination angle Horizontal +0.5°

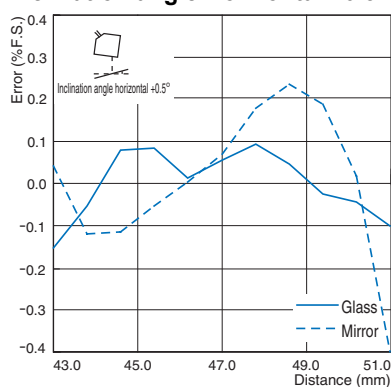

Inclination angle Horizontal -0.5°

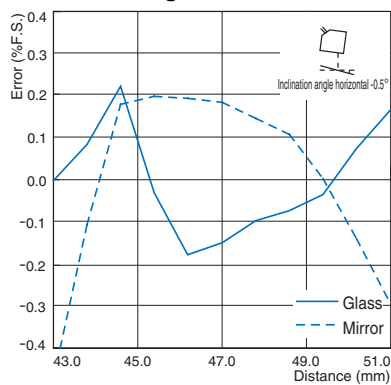

Inclination angle Vertical ±0.5°

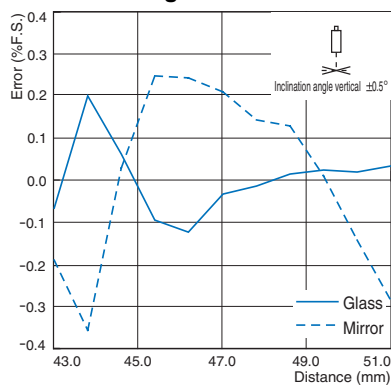

ZS-LD80 (mode: Standard)

Diffuse reflection

Inclination angle 0°

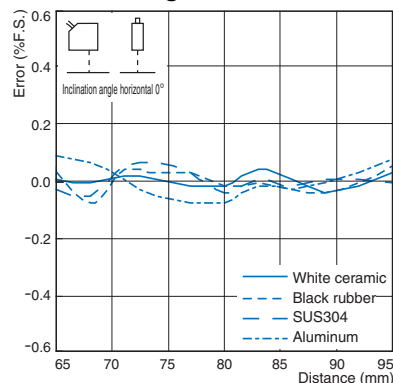

Inclination angle Horizontal +15°

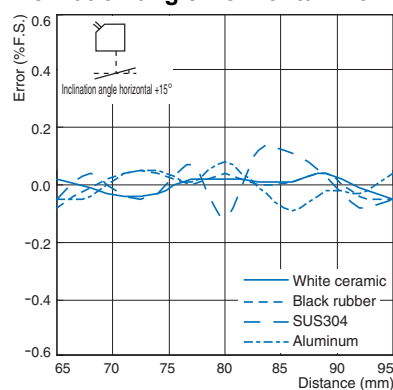

Inclination angle Horizontal -15°

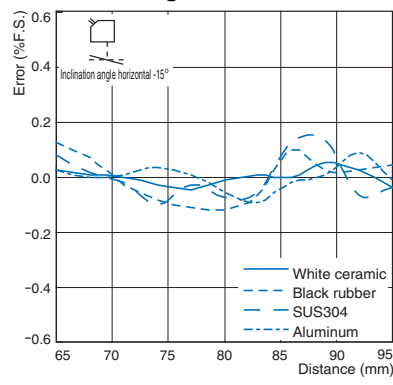

Inclination angle Vertical ±15°

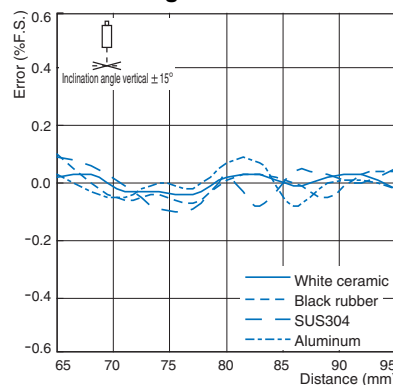

Regular reflection

Inclination angle 0°

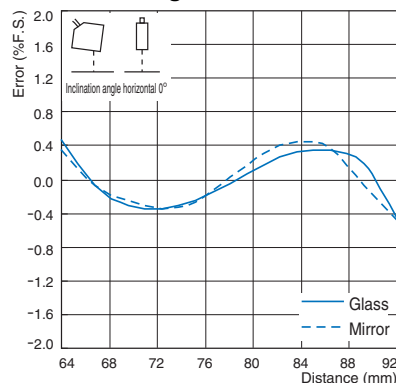

Inclination angle Horizontal +0.5°

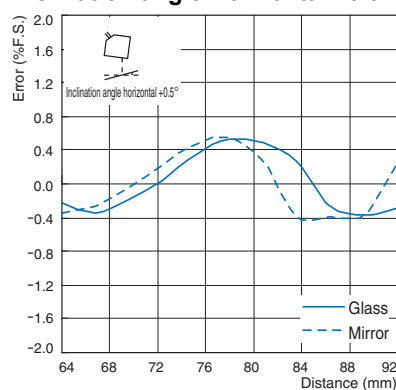

Inclination angle Horizontal -0.5°

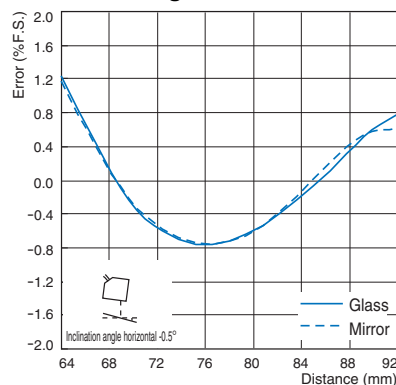

Inclination angle Vertical ±0.5°

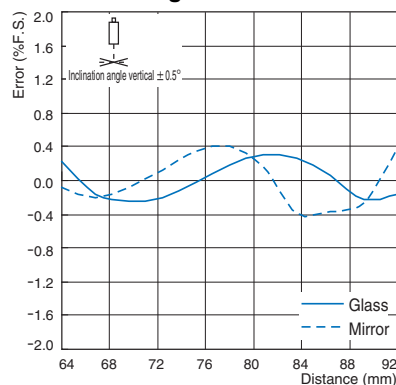

ZS-LD130 (mode: Standard)

Diffuse reflection

Inclination angle 0°

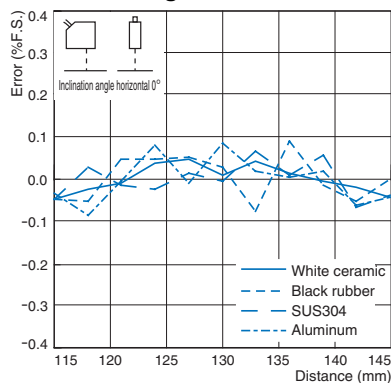

Inclination angle Horizontal +15°

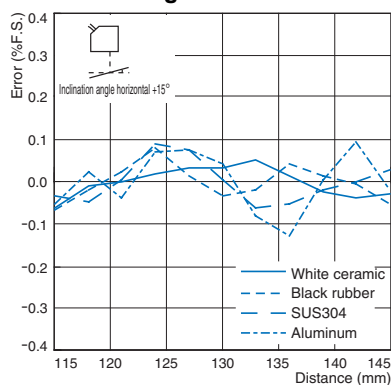

Inclination angle Horizontal -15°

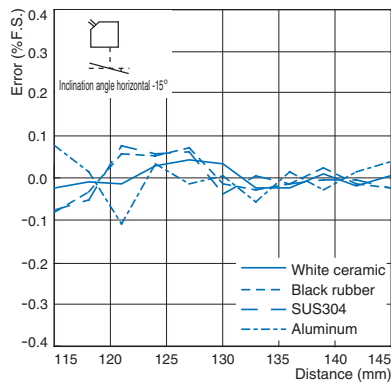

Inclination angle Vertical ±15°

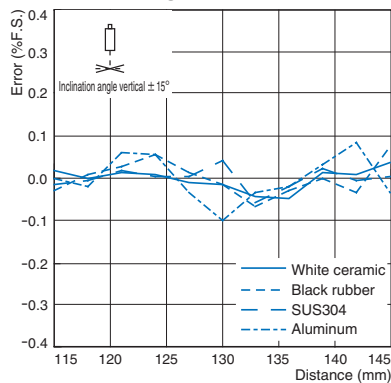

Regular reflection

Inclination angle 0°

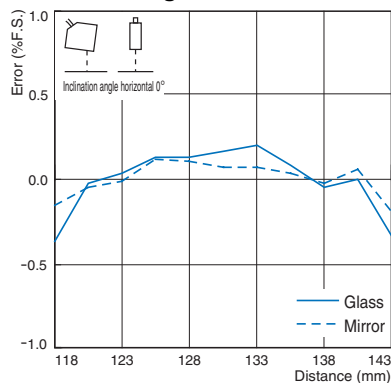

Inclination angle Horizontal +0.5°

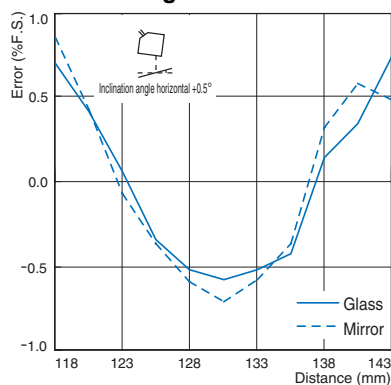

Inclination angle Horizontal -0.5°

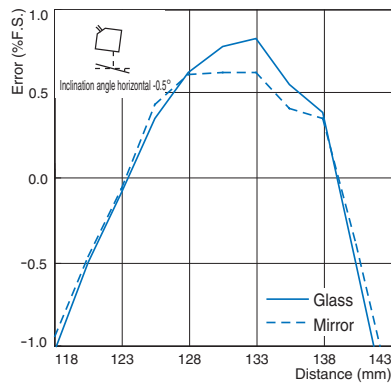

Inclination angle Vertical ±0.5°

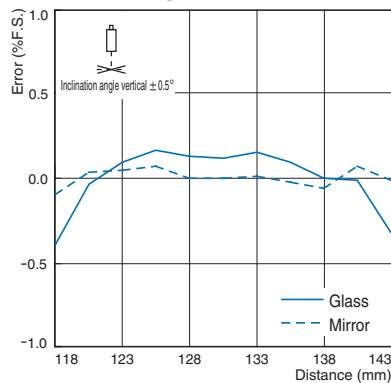

ZS-LD200 (mode: Standard)

Diffuse reflection

Inclination angle 0°

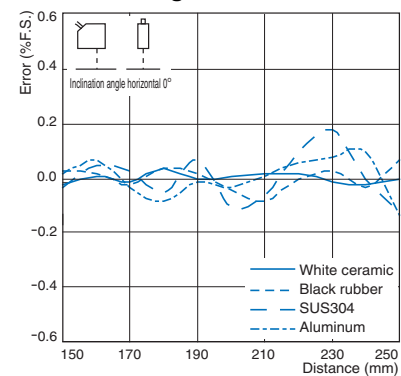

Inclination angle Horizontal +15°

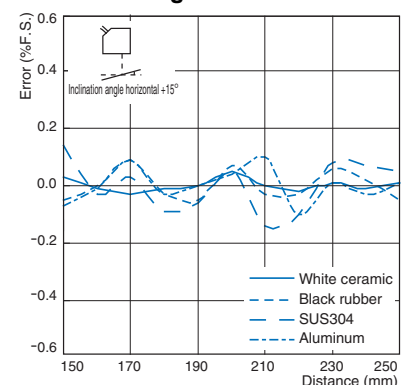

Inclination angle Horizontal -15°

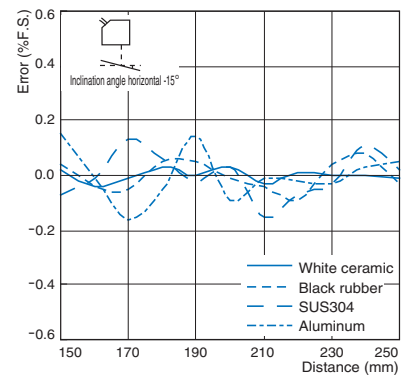

Inclination angle Vertical ±15°

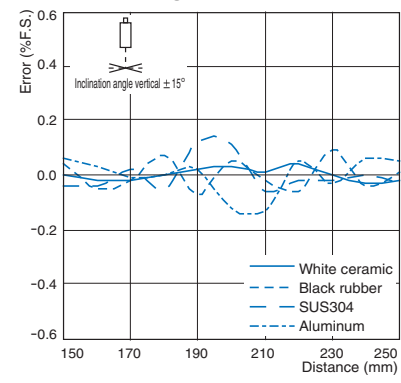

ZS-LD200 (mode: Standard)

Regular reflection

Inclination angle 0°

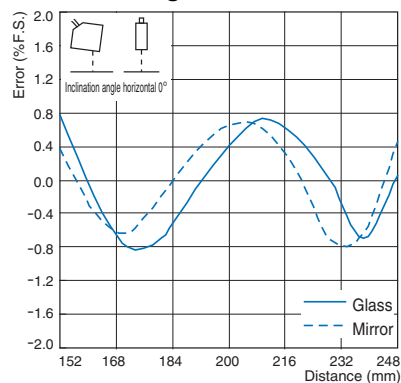

Inclination angle Horizontal +0.5°

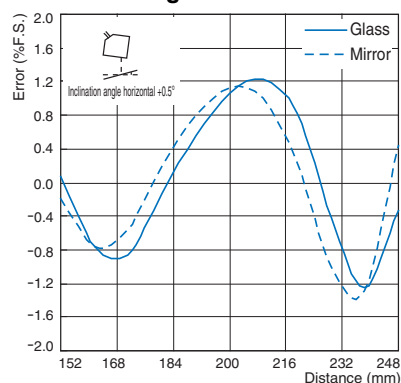

Inclination angle Horizontal -0.5°

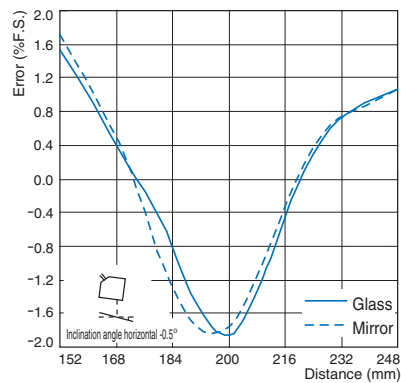

Inclination angle Vertical ±0.5°

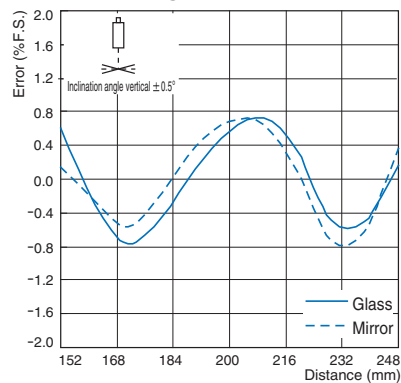

ZS-LD350S (mode: Standard)

Diffuse reflection

Inclination angle 0°

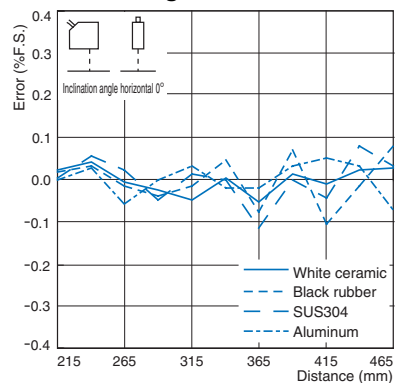

Inclination angle Horizontal +15°

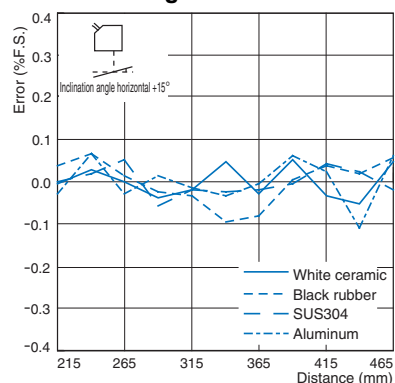

Inclination angle Horizontal -15°

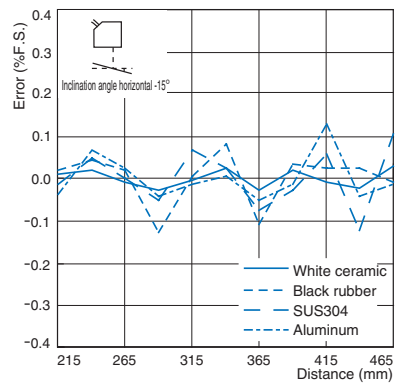

Inclination angle Vertical ±15°

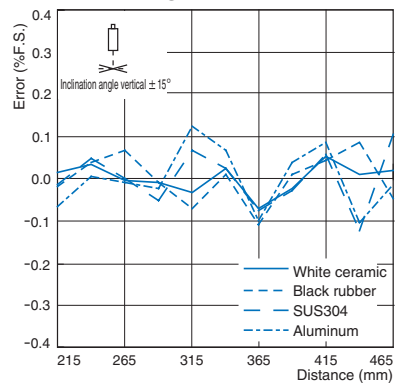

I/O Circuit Diagrams

ZS-HLDC11-N (NPN type)

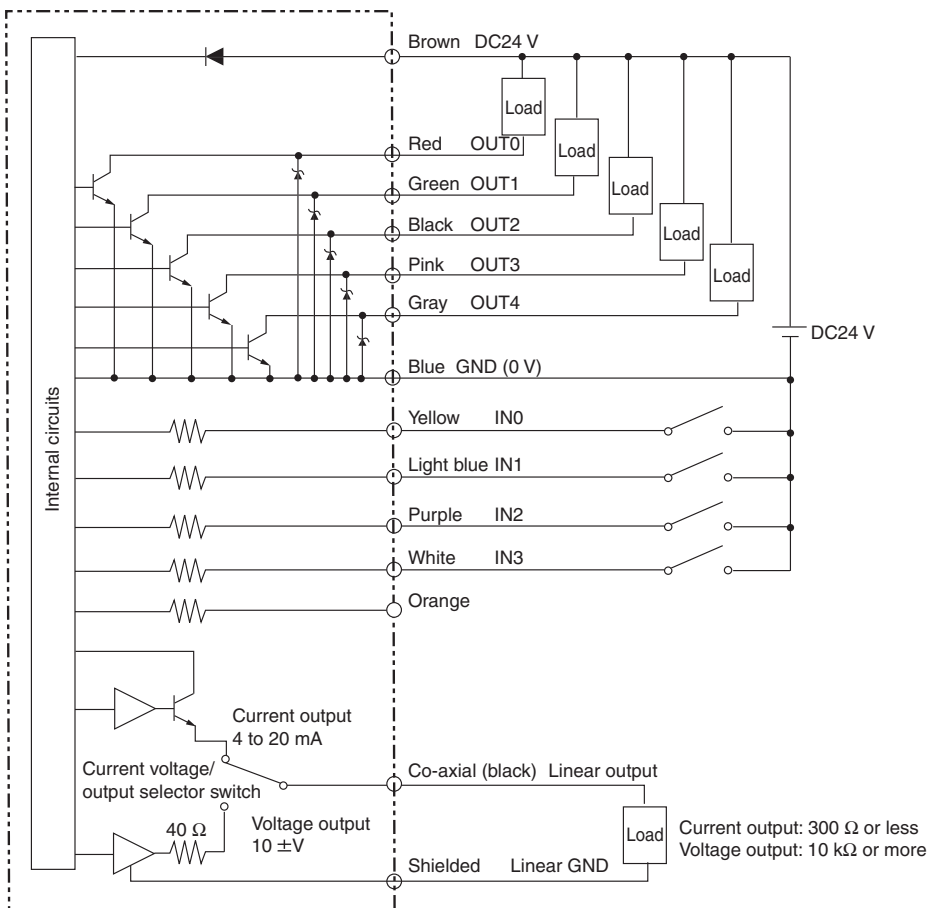

ZS-HLDC41-N (PNP type)

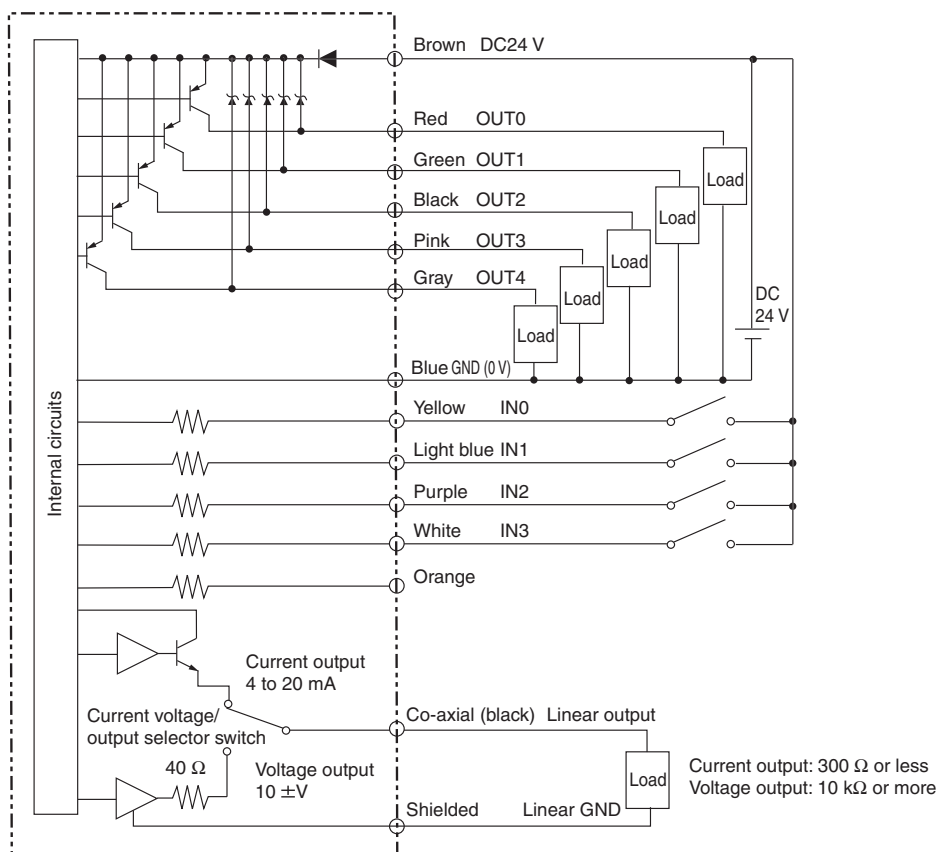

Safety Precautions

WARNING

This product is not designed or rated for ensuring safety of persons either directly or indirectly.



Do not use it for such purposes.

Do not expose your eyes to the laser radiation either directly or indirectly (i.e., after reflection from a mirror or shiny surface).



The laser radiation has a high power density and exposure may result in loss of sight.

Do not disassemble the product. Doing so may cause the laser beam to leak, resulting in the danger of visual impairment.



Laser Label Indications

Attach the following warning label to the side of the ZS series Sensor Head.



For details, including precautions for correct use, refer to the "ZS-HL-N Smart Sensor User's manual" (Cat. No. Z470) on your OMRON website.

For technical information and product FAQs, refer to the "Technical Guide" at your OMRON website.

Dimensions

(Unit: mm)

Sensor Heads

ZS-HLDS5T/HLDS10

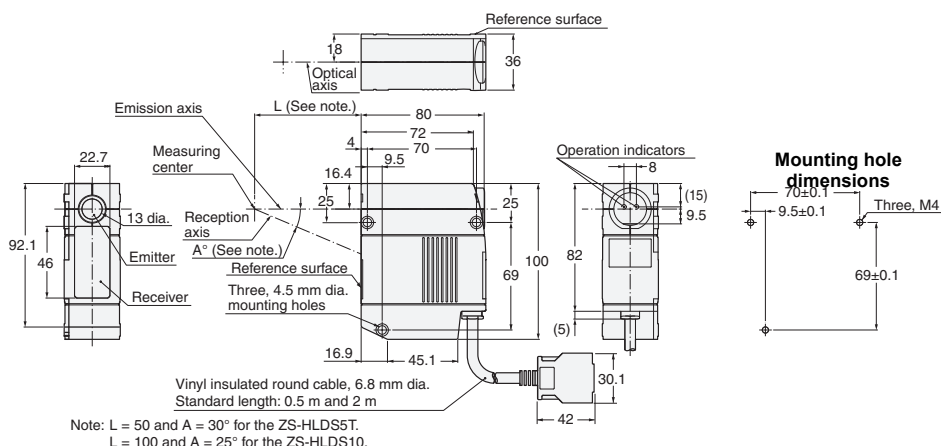

ZS-HLDS60/HLDS150

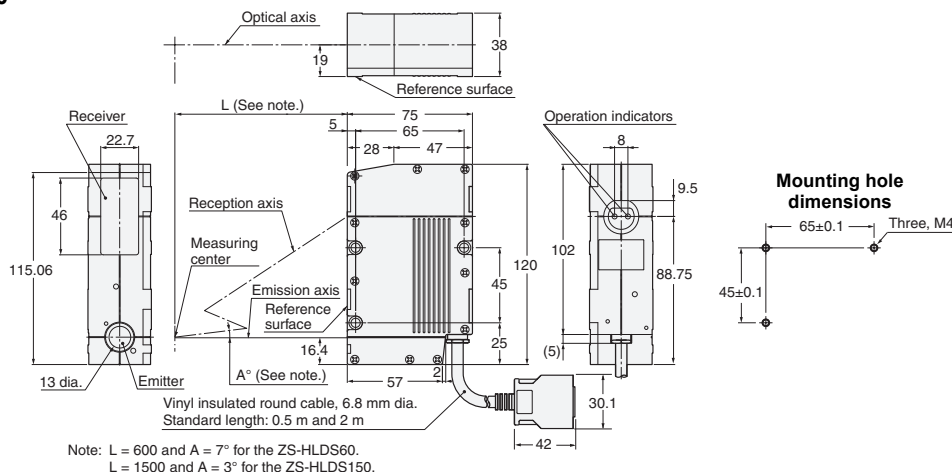

ZS-LD10GT

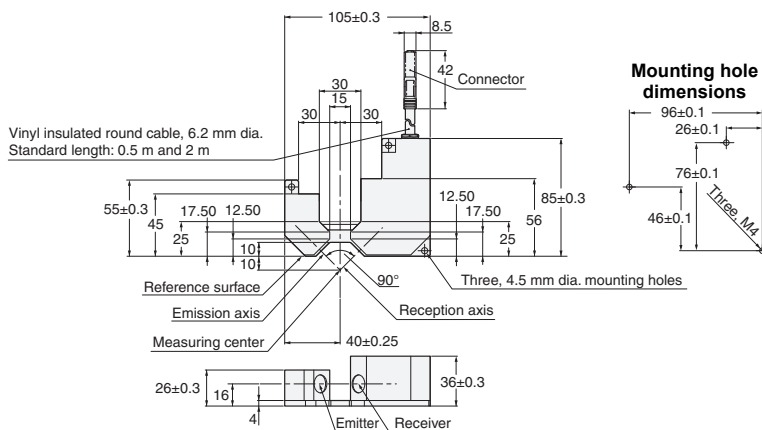

ZS-LD15GT

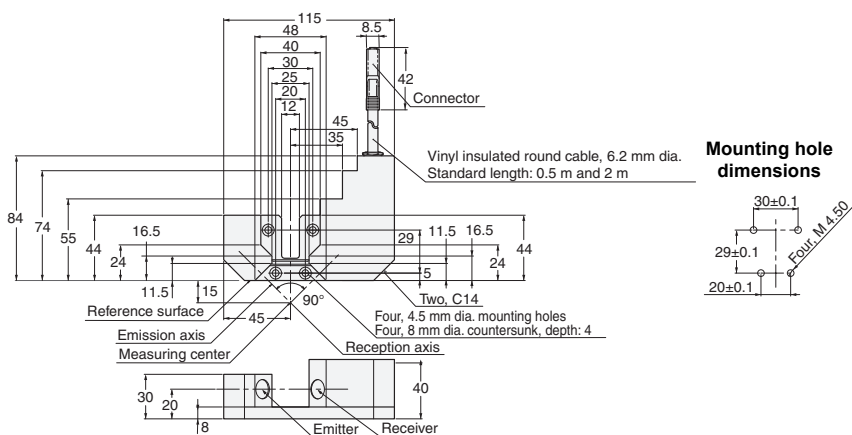

ZS-LD50/LD50S/LD80/LD130/LD200/LD350S

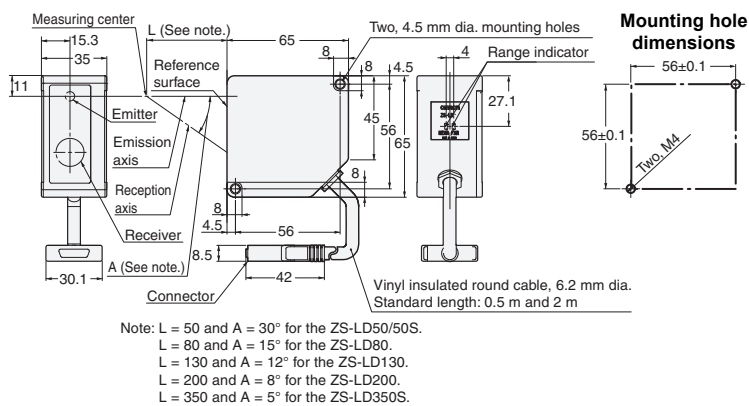

ZS-HLDS2VT/LD20T/LD20ST/LD40T

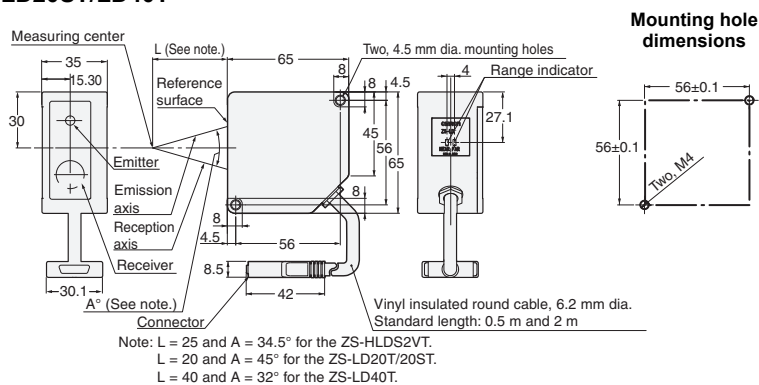

Sensor Controllers
ZS-HLDC□-N

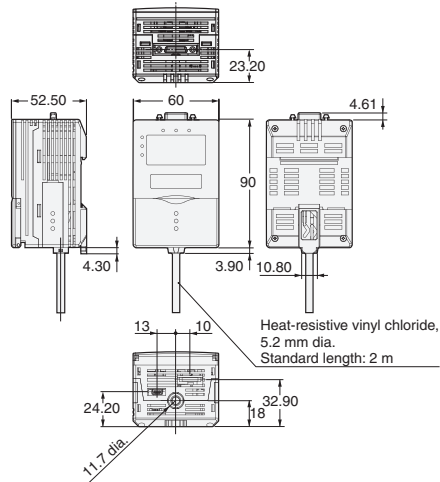

Realtime Parallel Output Unit
ZG-RPD□1-N

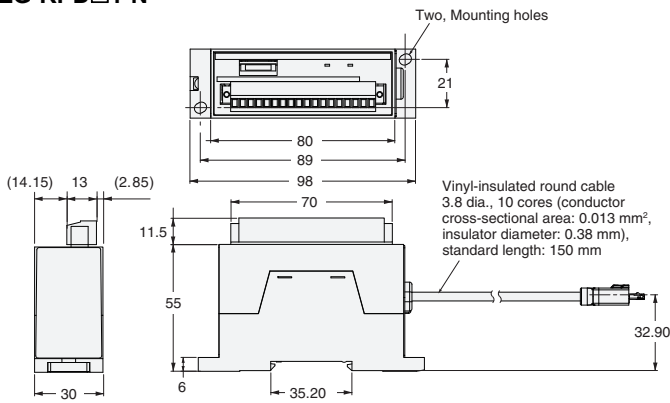

Panel Mount Adapter
ZS-XPM1/XPM2 (Dimensions for Panel Mounting)

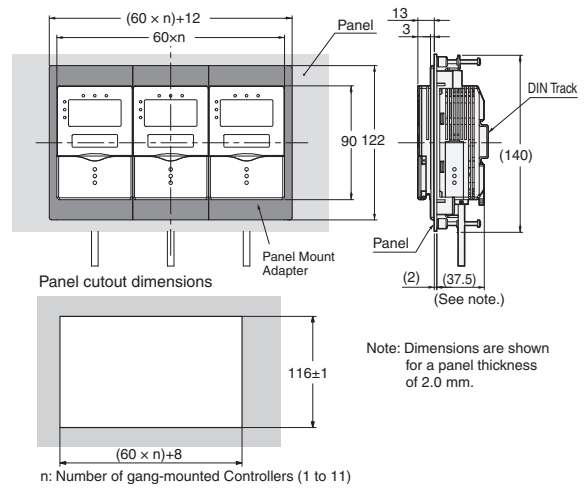

Digital Equalizer
ZS-XEQ

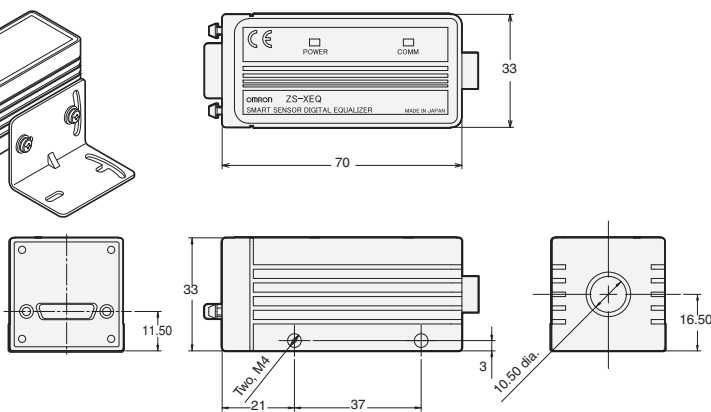
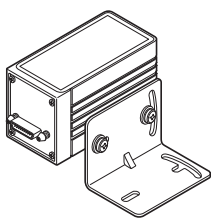

Mounting bracket

