

# PRODUCT DATASHEET

## SF CIRC 500 V 42W 830 IP44 DALI

SURFACE CIRCULAR 500 DALI | Wall and ceiling luminaire with IP44 and DALI-2 technology



VALUE  
CLASS

### Areas of application

- Corridors
- Stairways
- Bathrooms
- Foyers

### Product benefits

- Indoor luminaire with high luminous efficacy
- Integrated DALI-2 driver for extended functionalities
- Energy savings of up to 55 % compared to luminaires that use CFL
- Easy and quick installation
- Very homogenous light
- 5 years guarantee

### Product features

- Type of protection: IP44 (ceiling mounting), IP20 (wall mounting)
- Suitable for central battery emergency installations acc. to EN 60598-2-22
- Push DIM function for dimming and switching directly on a pushbutton
- Extended lifetime (L70/B10): up to 50,000 h (at 25°C)
- Impact resistance: IK03
- Metal housing, PMMA cover
- Ambient temperature in operation: -20...+40 °C



– Indoor use only, not suitable for outdoor use

## TECHNICAL DATA

### Electrical data

Nominal wattage	42.00 W
Nominal voltage	220...240 V
Mains frequency	0/50/60 Hz
Nominal current	180.000 mA
Inrush current	10.90 A
Inrush current time $T_{h50}$	330 $\mu$ s
Max. number of luminaires per miniature circuit breaker B16	25
Max. number of luminaires per miniature circuit breaker C10	26
Max. number of luminaires per miniature circuit breaker C16	43
Power factor $\lambda$	> 0.90
Total harmonic distortion	< 10 %
Protection class	I
Operating mode	Integrated LED driver
Dimming interface	DALI-2

### Photometrical data

Luminous flux	3500 lm
Luminous efficacy	83 lm/W
Color temperature	3000 K
Light color (designation)	Warm White
Color rendering index Ra	> 80
Standard deviation of color matching	< 5 sdc <sub>m</sub>
Low flicker	Yes
Flickering metric (Pst LM)	< 1
Stroboscope effect metric (SVM)	< 0.4
Photobiological safety group acc. to EN62778	RG0
Beam angle	120 °

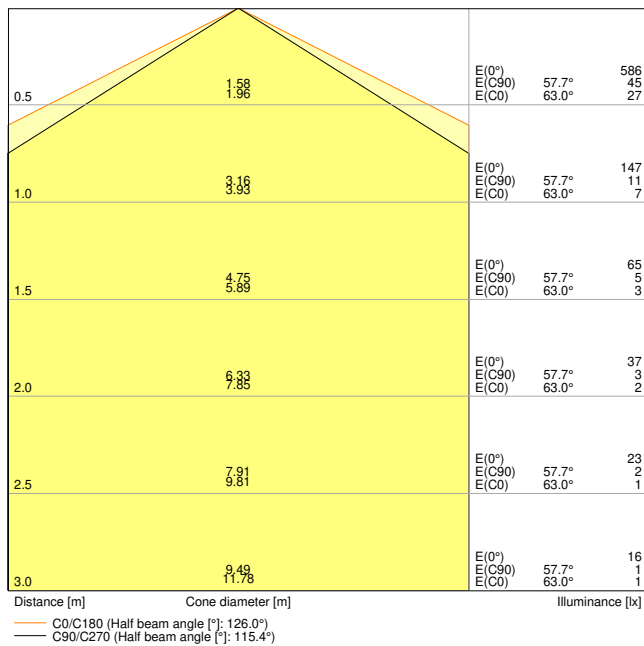

SF CIRC 500 V 42W 830 IP44 PS 3500LM DALI

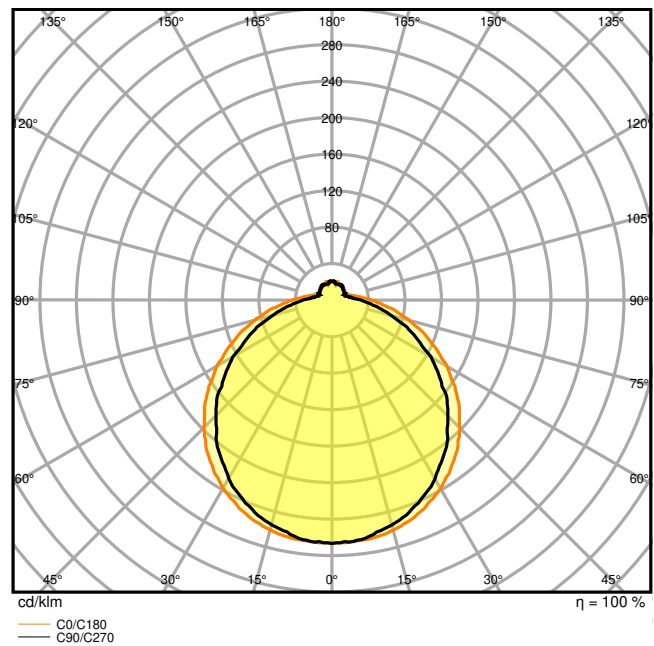

SF CIRC 500 V 42W 830 IP44 PS 3500LM DALI

### Dimensions & Weight

Diameter	500.00 mm
Height	105.00 mm
Product weight	1260.00 g

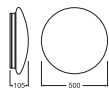

SF CIRC 500 V 42W IP44 PS and  
SF CIRC 500 SEN V 42W IP44 PS

### Materials & Colors

Product color	White
Housing color	White
Body material	Steel
Cover material	Polymethylmethacrylate (PMMA)
Light emitting surface material	Polymethylmethacrylate (PMMA)

Glow Wire Test according to IEC 60695-2-12	650 °C
Mercury content	0.0 mg

### Application & Mounting

Ambient temperature range	-20...+45 °C
Temperature range at storage	-20...+80 °C
Type of connection	Terminal, 5-pin
Type of protection	IP44
Protection class IK (shock resistance)	IK03
Dimmable	Yes
Type of dimming	DALI2
Mounting type	Surface
Mounting location	Ceiling / Wall
Application environment	Indoor
With light source	Yes

### Lifespan

Lifespan L70/B50 at 25 °C	50000 h <sup>1)</sup>
Lifespan L80/B10 at 25 °C	45000 h <sup>1)</sup>
Lifespan L80/B50 at 25 °C	45000 h
Lifespan L90/B10 at 25 °C	40000 h
Number of switching cycles	100000

<sup>1)</sup> t[h]: L70 / B50 @ 25 °C (Ta), t[h]: L80 / B10 @ 25 °C (Ta), t[h]: L90 / B10 @ 25 °C (Ta)

### Control gear

Output current	1000 mA
ECG - Output ripple current	< 30 %

### Emergency lighting

Wattage in emergency operation mode	6 W
Luminous flux in emergency operation mode	550 lm

### Certificates & Standards

Standards	CE / CB / TÜV / UKCA / EAC
Luminaire with limited surface temperature, "D sign"	No
Ball shot safe	No
Replaceable light source (EPREL)	Not replaceable













## Additional product data



Added function	VIVARES
----------------	---------

## EQUIPMENT / ACCESSORIES

– Replacement cover optionally available

## DOWNLOAD DATA

Documents and certificates		Document name
	User instruction / safety instructions	SF CIRC 500
	Legal information	LISO Insert SF CIRCULAR 500
	Legal information	Legal Insert SF CIRCULAR 500
	Legal information	Informationstext 18 Abs 4 ElektroG
	Declarations of conformity	SF CIRCULAR
	Declarations of conformity UKCA	SF CIRCULAR
Photometric and lighting design files		Document name
	IES file (IES)	SF CIRC 500 V 42W 830 IP44 PS 3500LM DALI
	LDT file (Eulumdat)	SF CIRC 500 V 42W 830 IP44 PS 3500LM DALI
	ULD file (DIALux)	SF CIRC 500V 42W 830 IP44 DALI
	ROLF file (RELUX)	SURFACE CIRCULAR 500 DALI 42W 830
	UGR file (UGR table)	SF CIRC 500 V 42W 830 IP44 PS 3500LM DALI
	Light distribution curve type cone	SF CIRC 500 V 42W 830 IP44 PS 3500LM DALI
	Light distribution curve type polar	SF CIRC 500 V 42W 830 IP44 PS 3500LM DALI

CAD/BIM files		Document name
	BIM Revit 3D	SURFACE CIRCULAR
	CAD STEP 3D	SF CIRC 500

Tender texts		Document name
	Tender documents	SURFACE CIRCULAR 500 DALI 42W 830 IP44 DALI-EN

**LOGISTICAL DATA**

Product code	Packaging unit (Pieces/Unit)	Dimensions (length x width x height)	Gross weight	Volume
4099854077890	Folding box 1	112 mm x 527 mm x 534 mm	1732.00 g	31.52 dm <sup>3</sup>
4099854077906	Shipping box 5	582 mm x 547 mm x 564 mm	10699.00 g	179.55 dm <sup>3</sup>

The mentioned product code describes the smallest quantity unit which can be ordered. One shipping unit can contain one or more single products. When placing an order, for the quantity please enter single or multiples of a shipping unit.

**ADDITIONAL CATALOG INFORMATION**

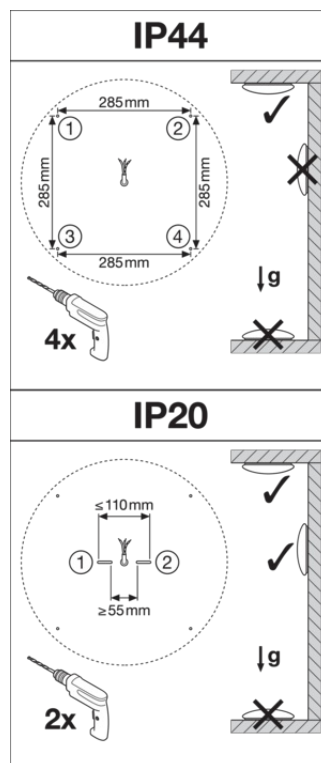
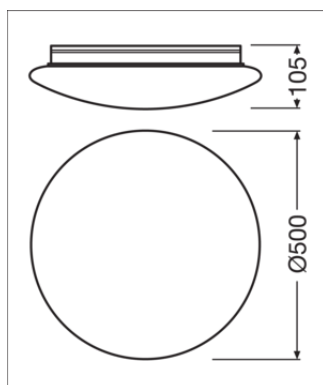

## References / Links

– For Guarantee see [www.ledvance.com/guarantee](http://www.ledvance.com/guarantee)

---

## DISCLAIMER

Subject to change without notice. Errors and omission excepted. Always make sure to use the most recent release.