

PRODUCT DATASHEET

MANUAL CONTROL UNIT TOUCH DALI-2 TW

MANUAL CONTROL UNIT TOUCH DALI-2 TW | Manual control unit with touch display for up-to 25 lights, enables Tunable White lighting



Areas of application

- One-room solution for up to 4 access areas
- Meeting and conference rooms
- Restaurants
- Shop lighting
- Private homes

Product benefits

- Simple, intuitive operation
- Manual dimming, switching and saving of light settings
- Individual adjustment of the brightness level and color temperature
- Behavior after power interruption can be set
- High quality glass cover
- Mains powered (active mode) or DALI powered (passive mode) operation
- Optional surface mount frame available
- Compatible with LEDVANCE VIVARES DALI light management system (LEDVANCE DALI luminaires)

Product features

- DALI-2 control device for installation in standard flush-mounted boxes
- Touch surface for manual light control
- Up to 4 control devices can be connected in parallel to set up several control points
- Automatic synchronization between control points
- Number of DALI lights per control unit: up to 25
- Cable length of the DALI control cable: up to 300 m

TECHNICAL DATA

Electrical data

Nominal wattage	2.70 W
Nominal voltage	100...240 V
Input current	48 mA
Mains frequency	50...60 Hz

Dimensions & Weight

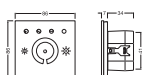

Length	86.00 mm
Width	86.00 mm
Height	41.00 mm
Cable cross-section, input side	0.5...1.5 mm ²
Wire preparation length, input side	6...7 mm
Product weight	200.00 g

Colors & materials

Product color	White
---------------	-------

Temperatures & operating conditions

Ambient temperature range	-20...+50 °C
Maximum temperature at tc test point	52 °C

Lifespan

Number of switching cycles	30000
----------------------------	-------

Additional product data

Product remark	Available from September 2024 / Only Sensors with mains switching contact
Number of control outputs	1
Max. connectable push button couplers / sensors	16
Max. number of connected drivers	25
Commissioning App	Ready to use
Light control tool App	No
Groups	1

Capabilities

Dimmable	Yes
Dimming interface	DALI-2
Dimming range	1...100 %
Number of control outputs	1
Type of installation	Integrated in flush device box







Certificates & Standards

Approval marks – approval	CE / UKCA / EAC
Protection class	II
Type of protection	IP20

Accessories Optional

Product image	Product name	EAN
	SURFACE MOUNT FRAME	4058075843561

DOWNLOAD DATA

Documents and certificates		Document name
	User instruction / safety instructions	MCU TOUCH DALI-2
	Extended installation guide	Application guide MCU TOUCH DALI-2 controllers
	Legal information	Legal Insert DALI COMPONENTS
	Legal information	Informationstext 18 Abs 4 ElektroG
	Declarations of conformity	MCU DALI
	Declarations of conformity UKCA	MCU DALI
Tender texts		Document name
	Tender documents	MANUAL CONTROL UNIT TOUCH DALI-2 TW-EN

LOGISTICAL DATA

Product code	Packaging unit (Pieces/Unit)	Dimensions (length x width x height)	Gross weight	Volume
4058075837560	Folding box 1	102 mm x 112 mm x 55 mm	244.00 g	0.63 dm ³
4099854334702	Shipping box 30	320 mm x 320 mm x 250 mm	7968.00 g	25.60 dm ³

The mentioned product code describes the smallest quantity unit which can be ordered. One shipping unit can contain one or more single products. When placing an order, for the quantity please enter single or multiples of a shipping unit.

ADDITIONAL CATALOG INFORMATION

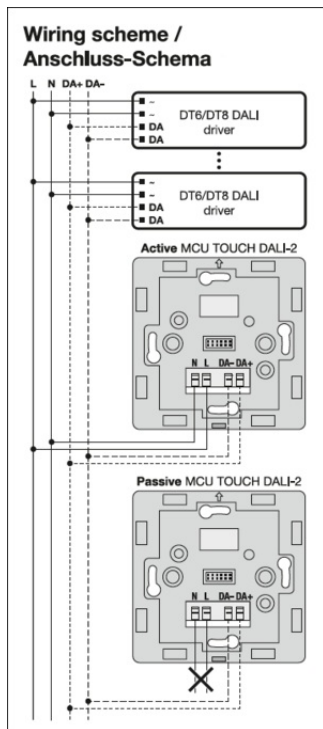

Maximum number of devices / Maximale Geräteanzahl				
Active MCU TOUCH / MCU TOUCH TW	1	2	3	4
Passive MCU TOUCH / MCU TOUCH TW	1	2	1	-
DALI driver	25	50	75	100

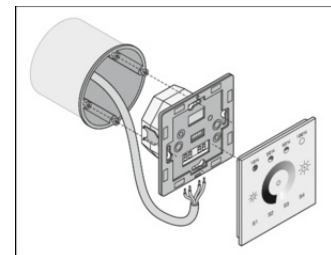

References / Links

– For current information see www.ledvance.com/light-management-systems

DISCLAIMER

Subject to change without notice. Errors and omission excepted. Always make sure to use the most recent release.