



PRODUCT DATASHEET

FL PFM ASYM 45x140 290 W 3000 K BK

FLOODLIGHT PERFORMANCE ASYM 45x140 | Floodlight with very wide beam, asymmetric light distribution for area lighting



Areas of application

- Direct replacement for luminaires using HID lamps
- Outdoor use (IP66)
- Parking
- Public areas
- Industry
- Sports facilities
- Parking lots, industrial roads
- D-sign according to EN 60598-2-24 for fire-risk commercial unit, e.g. by accumulation of dust

Product benefits

- Energy savings of up to 90 % compared to halogen lamp floodlights
- Energy savings of up to 45 % compared to luminaires that use conventional discharge lamps
- Bright, robust and durable
- Homogeneous luminance distribution and reduced glare
- No upper light output ratio (ULOR 0%) when mounted at 0° tilt
- Key hole to ensure ease of installation
- 5 years guarantee

Product features

- High luminous efficacy: up to 140 lm/W
- Asymmetric light distribution for area lighting
- Angled (45°) mounting bracket and up to 180° tilting
- Type of protection: IP66
- Impact resistance: IK08



- Ambient temperature in operation: -30...+50 °C
- High surge protection: up to 10 kV (L/N-PE), 6 kV (L-N)
- Integrated breather for preventing condensation inside the luminaire
- Connection via 2 m cable, wiring required

TECHNICAL DATA

Electrical data

| | |
|---|-----------------------|
| Nominal wattage | 290.00 W |
| Nominal voltage | 220...240 V |
| Mains frequency | 50...60 Hz |
| Nominal current | 1420 mA |
| Inrush current | 29 A |
| Inrush current time T_{h50} | 1000 μ s |
| Max. number of luminaires per miniature circuit breaker B16 | 4 |
| Max. number of luminaires per miniature circuit breaker C10 | 4 |
| Max. number of luminaires per miniature circuit breaker C16 | 7 |
| Power factor λ | > 0.90 |
| Total harmonic distortion | < 20 % |
| Protection class | I |
| Operating mode | Integrated LED driver |

Photometrical data

| | |
|--|---------------------------|
| Luminous flux | 35300 lm |
| Luminous efficacy | 120 lm/W |
| Color temperature | 3000 K |
| Light color (designation) | Warm White |
| Color rendering index Ra | > 80 |
| Standard deviation of color matching | ≤ 5 sdc _m |
| Luminous intensity | - |
| Low flicker | Yes |
| Flickering metric (Pst LM) | - |
| Stroboscope effect metric (SVM) | - |
| Photobiological safety group acc. to EN62778 | RG1 |
| Beam angle | 45 ° x 140 ° |

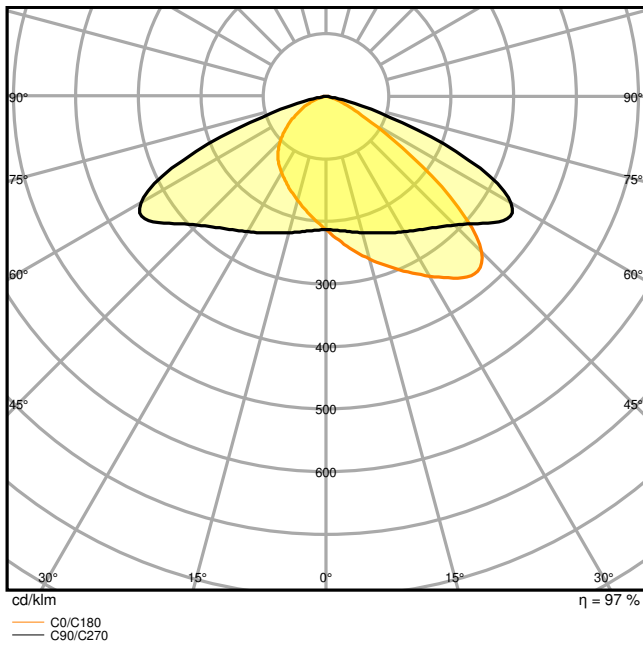

FL PFM 290W 3000K ASYM 45x140 BK

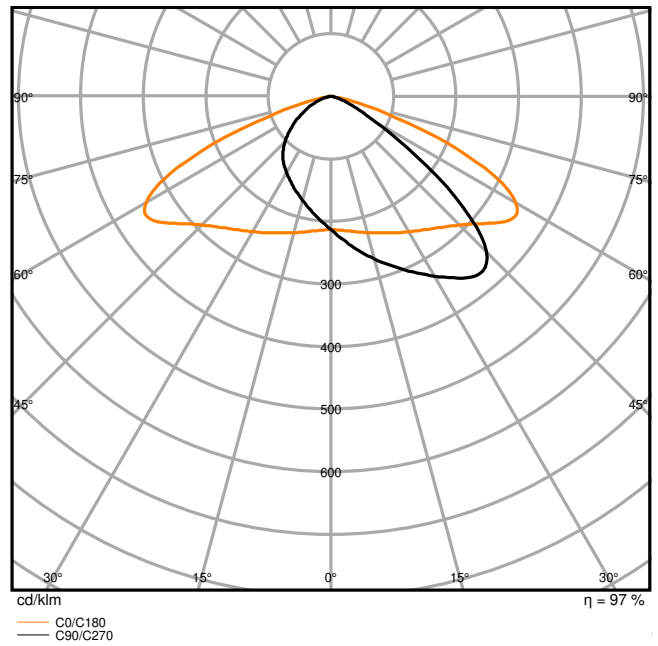

FL PFM 290W 3000K ASYM 45X140 BK

Dimensions & Weight

| | |
|----------------|-----------|
| Length | 567.00 mm |
| Width | 465.00 mm |
| Height | 97.00 mm |
| Product weight | 9500.00 g |
| Cable length | 2000 mm |

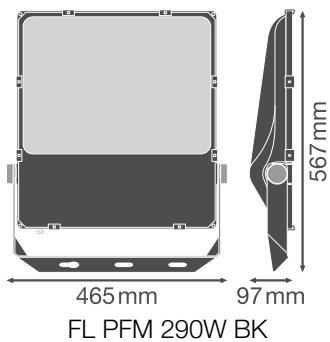

Materials & Colors

| | |
|--|----------|
| Product color | Black |
| Housing color | Black |
| Body material | Aluminum |
| Cover material | Glass |
| Light emitting surface material | Glass |
| Glow Wire Test according to IEC 60695-2-12 | 650 °C |
| Mercury content | 0.0 mg |

Application & Mounting

| | |
|--|-------------------------------|
| Ambient temperature range | -30...+50 °C |
| Temperature range at storage | -40...+70 °C |
| Type of connection | Cable, 3-pole |
| Type of protection | IP66 |
| Protection class IK (shock resistance) | IK08 |
| Dimmable | No |
| Mounting type | Surface |
| Mounting location | Wall / Pole / Floor / Ceiling |
| Application environment | Outdoor |
| Adjustable | Yes |
| With light source | Yes |

Lifespan

| | |
|----------------------------|------------------------|
| Lifespan L70/B50 at 25 °C | 100000 h ¹⁾ |
| Lifespan L80/B10 at 25 °C | 70000 h ¹⁾ |
| Lifespan L80/B50 at 25 °C | 70000 h |
| Lifespan L90/B10 at 25 °C | 30000 h |
| Number of switching cycles | 100000 |

¹⁾ t[h]: L70 / B50 @ 25 °C (Ta), t[h]: L80 / B10 @ 25 °C (Ta), t[h]: L90 / B10 @ 25 °C (Ta)

Control gear

| | |
|-----------------------------|---------|
| Output current | 5500 mA |
| ECG - Output ripple current | < 10 % |

Certificates & Standards











| | |
|--|--------------------------------|
| Standards | CE / CB / ENEC / TÜV SÜD / EAC |
| Luminaire with limited surface temperature, "D sign" | Yes |







| | |
|----------------------------------|-----------------|
| Ball shot safe | Yes |
| Replaceable light source (EPREL) | Not replaceable |

Safety advice

- All electrical connections must be made by a qualified person.
- The external flexible cable or cord of this luminaire cannot be replaced; if the cord is damaged, the luminaire shall be destroyed.
- Terminal block not included. Installation must be made by a qualified person.
- Caution, risk of electric shock.
- Product in protection class I. All electrically conductive, metallic housing parts that can absorb voltage during operation or during maintenance in the event of a fault must be continuously connected to the protective earthing conductor.

DOWNLOAD DATA

| Documents and certificates | | Document name |
|--|--|-------------------------------------|
|  | User instruction / safety instructions | FLOODLIGHT PERFORMANCE |
|  | Legal information | LSI FL PFM SYM AND ASYM |
|  | Legal information | Legal Insert FL PFM |
|  | Legal information | Informationstext 18 Abs 4 ElektroG |
|  | Declarations of conformity | EU Declaration of Conformity FL PFM |
|  | Declarations of conformity UKCA | FL PFM BK |
| Photometric and lighting design files | | Document name |
|  | IES file (IES) | FL PFM 290W 3000K ASYM 45x140 BK |
|  | IES file (IES) | FL PFM 290W 3000K ASYM 45X140 BK |
|  | LDT file (Eulumdat) | FL PFM 290W 3000K ASYM 45x140 BK |
|  | LDT file (Eulumdat) | FL PFM 290W 3000K ASYM 45X140 BK |
|  | ULD file (DIALux) | FL PFM 290W-3000K ASYM 45X140 BK |

| Photometric and lighting design files | | Document name |
|--|-------------------------------------|---|
|  | ROLF file (RELUX) | FL PFM 290W-3000K ASYM |
|  | Light distribution curve type polar | FL PFM 290W 3000K ASYM 45x140 BK |
|  | Light distribution curve type polar | FL PFM 290W 3000K ASYM 45X140 BK |
| CAD/BIM files | | Document name |
|  | BIM Revit 3D | FL PFM |
|  | CAD STEP 3D | FL PFM 290W |
| Tender texts | | Document name |
|  | Tender documents | FLOODLIGHT PERFORMANCE ASYM 45x140 290 W 3000 K BK-EN |

LOGISTICAL DATA

| Product code | Packaging unit (Pieces/Unit) | Dimensions (length x width x height) | Gross weight | Volume |
|---------------|------------------------------|--------------------------------------|--------------|-----------------------|
| 4058075353732 | Shipping box 1 | 652 mm x 160 mm x 510 mm | 10258.00 g | 53.20 dm ³ |

The mentioned product code describes the smallest quantity unit which can be ordered. One shipping unit can contain one or more single products. When placing an order, for the quantity please enter single or multiples of a shipping unit.

ADDITIONAL CATALOG INFORMATION

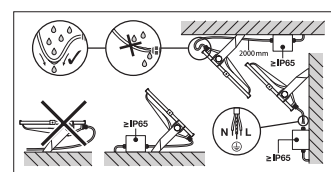
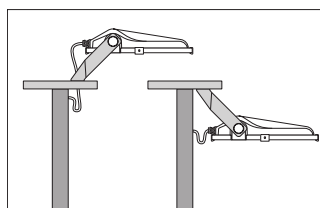
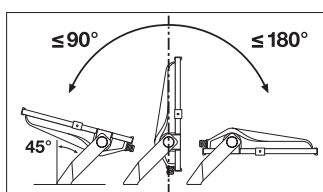

References / Links

– For Guarantee see www.ledvance.com/guarantee

DISCLAIMER

Subject to change without notice. Errors and omission excepted. Always make sure to use the most recent release.