

AXOLUTE

TV - RD - SAT sockets

Cat. No(s): HD4202D - HC4202D - HS4202D - HD4202P - HC4202P - HS4202P - HD4202PT - HC4202PT - HS4202PT
HD4202DC - HC4202DC - HS4202DC - HD4269F - HC4269F - HS4269F - HD4214D - HC4214D - HS4214D
HD4201D - HC4201D - HS4201D - HD4210D - HC4210D - HS4210D - HD4211D - HC4211D - HS4211D
HD4213D - HC4213D - HS4213D

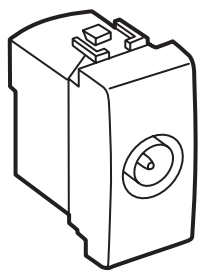

HD4202D

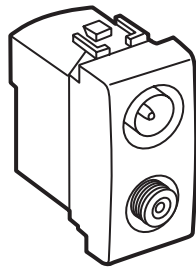

HD4214D

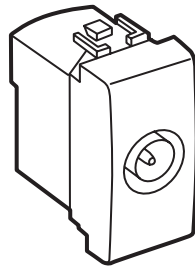

HD4210D

CONTENTS

Page

1. Use	1
2. Range	1-2
3. Overall dimensions	2
4. Connection	2
5. Cabling precautions	2
6. Technical characteristics	2
7. Performance	3
8. Cleaning	3
9. Accessories	3
10. Standards and approvals	3

1. USE

For TV-R sockets: installation on cabled network, hertzian distribution or vestigial sideband amplitude modulation (VSD-AM) (collective satellite reception without individual demodulator).

For TV-R-SAT sockets: hertzian and satellite installation with individual demodulator.



2. RANGE

SCREENED TV SOCKETS		Cat. No.
	Shunted coaxial jack - Ø 9.5 mm male jack - 1 module Screened TV + SAT sockets in die-casting housing with current flow.	<input type="checkbox"/> HD4202D <input type="checkbox"/> HC4202D <input type="checkbox"/> HS4202D
	As above Pass through jack 1 module	<input type="checkbox"/> HD4202P <input type="checkbox"/> HC4202P <input type="checkbox"/> HS4202P
	As above Pass through jack with built in 75 Ω impedance adapter 1 module	<input type="checkbox"/> HD4202PT <input type="checkbox"/> HC4202PT <input type="checkbox"/> HS4202PT
	Shunted coaxial jack - Ø 9.5 mm - male jack Screened TV sockets in die-casting housing without current flow 1 module	<input type="checkbox"/> HD4202DC <input type="checkbox"/> HC4202DC <input type="checkbox"/> HS4202DC
	Shunted demixed TV + SAT jack in die-casting housing 1 module	<input type="checkbox"/> HD4214D <input type="checkbox"/> HC4214D <input type="checkbox"/> HS4214D
SCREENED TV + RD+ SAT sockets		Cat. No.
	Screened TV + RD + SAT jacks in die-casting housing with current flow 2 modules	<input type="checkbox"/> HD4210D <input type="checkbox"/> HC4210D <input type="checkbox"/> HS4210D
	Double coaxial shunted sockets for TV and RD - LMC reception - Ø 9.5 mm 2 modules - Belgium	<input type="checkbox"/> HD4211D <input type="checkbox"/> HC4211D <input type="checkbox"/> HS4211D
	Double coaxial shunted jack for TV and FM - LMC reception - Ø 9.5 mm 2 modules - France	<input type="checkbox"/> HD4213D <input type="checkbox"/> HC4213D <input type="checkbox"/> HS4213D

Color code:

- White
- Tech
- Anthracite

2. RANGE (continued)

TYPE F TV		Cat. No.
	Type F TV female connector - 75 Ω impedance - Screw coupling 1 module	<input type="checkbox"/> HD4269F <input checked="" type="checkbox"/> HC4269F <input checked="" type="checkbox"/> HS4269F
	Shunted TV coaxial - Female TV PRESET	<input type="checkbox"/> HD4201D <input checked="" type="checkbox"/> HC4201D <input checked="" type="checkbox"/> HS4201D

3. OVERALL DIMENSIONS (mm)

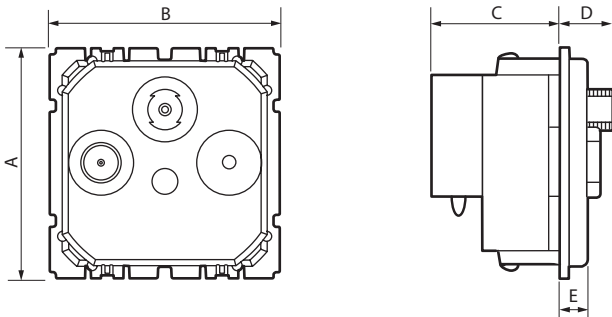

References	A	B	C	D	E
H*4002*	45	22.5	30	10	9.5
H*4214D	45	22.5	30	x	9.5
H*4210D	45	45	26	12.5	9.5
H*4211D	45	45	23	x	9.5
H*4213D	45	45	23	x	9.5
H*4269F	45	22.5	12	11	9.5
H*4201D	45	22.5	30	x	9.5

4. CONNECTION

For TV + RD + SAT only

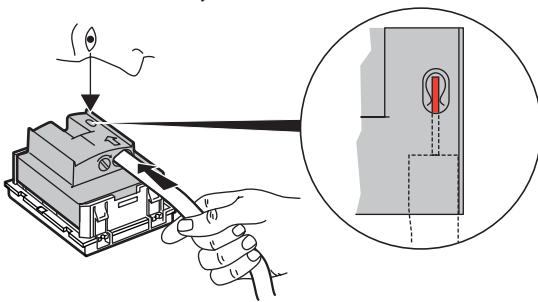

5. CABLING PRECAUTIONS

Stripping length

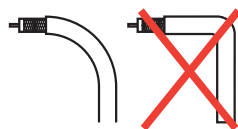
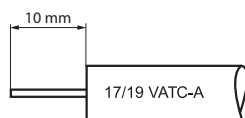

6. TECHNICAL CHARACTERISTICS

■ **6.1 Protection index**

Impact test: IK 02
Penetration by solid bodies/liquids: IP 20

■ **5.2 Material characteristics**

Material:
- Mechanism: Polycarbonate
- Key cover: ABS
Colours: White, Tech, Anthracite
Halogen free.
UV resistant.

Self extinguishing:

- 850° C / 30 s for insulating parts holding live parts in place.
- 650° C / 30 s for other parts made of insulating materials.

■ **5.3 Electrical characteristics**



- Male TV connector Ø 9.52 mm to IEC 61169-2
- Female FM connector Ø 9.52 mm to IEC 61169-2
- "F" female screw-in connector Ø 9.4 mm
- Self-extinguishing: 650° C / 30 s
- Frequency bands: TV : 5 - 68 / 120 - 862 MHz
FM: 87.5 - 108 MHz
SAT: 950 - 2400 MHz

- Typical impedance: 75 Ω
- Feedback channel on TV connector
- Loss through shield: UHF > 65 dB
VHF > 75 dB
SAT > 55 dB
- Max. Ø of incoming cable on input: 7 mm

■ **5.4 Climatic characteristics**

Storage and operating temperature: - 5° C to + 35° C

7. PERFORMANCE



Cat. No.	Zo			B1	FM	VHF	UHF	SAT IF							
	Ohm									22 / 0.6	40 - 68	87.5 - 108	120 - 470	470 - 862	950 - 2150
	Ω								V/mA	KHz / V	MHz	MHz	MHz	MHz	MHz
HD/HC/HS4202D HD/HC/HS4202D/2 HD/HC/HS4201D	75														
		500 mA				1.5 dB									
HD/HC/HS4202P	75					14 dB									
HD/HC/HS4202PT	75					10 dB									
HD/HC/HS4202DC	75														
HD/HC/HS4214D	75	TV				1.5 dB									
		SAT	500 mA	1.5 dB				1.5 dB							
HD/HC/HS4210D	75	TV			1.5 dB		1.5 dB								
		RD				1.5 dB									
		SAT	500 mA	1.5 dB				1.5 dB							
HD/HC/HS4211D HD/HC/HS4213D	75	TV			1.5 dB		1.5 dB								
		RD				1.5 dB									

8. CLEANING

Surface cleaning with a cloth.
 Do not use: acetone, tar remover, trichloroethylene.

Caution: A preliminary test should be carried out if other specific cleaning products are to be used.

9. ACCESSORIES

	Designation	Cat. No.
	Front cover for TV + FM socket	□ HD4204 ■ HC4204 ■ HS4204
	Front cover for TV + FM + SAT socket	□ HD4207 ■ HC4207 ■ HS4207
	Front cover for TV/FM + SAT socket	□ HD4212 ■ HC4212 ■ HS4212

10. STANDARDS AND APPROVALS

Compliance with standards of installation and manufacturing.
 Refer to e. catalogue.