

PRODUCT DATASHEET

LN INV D 1500 P 52W 940 DAVR WT

LINEAR INDIVILED DIRECT 1500 DALI | Surface mounted luminaire for single or light line office application with CRI90 and DALI-2 IoT technology, 1500 mm

Areas of application

- Direct replacement for luminaires with fluorescent lamps
- Offices, education, public buildings
- Single and continuous line configuration
- Direct lighting



Product benefits

- Easy upgradeability of light source and driver (EVERLOOP design)
- Homogenous light distribution and reduced glare ($UGR \leq 19$) thanks to IndiviLED® optics
- High performance with CRI90 and up to 135 lm/W
- IoT-ready luminaire with DALI-2 driver, suitable for VIVARES and other Light Management Systems
- Symmetric and asymmetric light distribution for various application areas
- Extended services such as energy monitoring and remote maintenance possible with DALI versions
- High color consistency with SDCM 3
- Easy installation
- Low flicker light thanks to special electronic control gear
- Suitable for battery emergency installations acc. to EN 60598-2-22
- Multiple mounting options thanks to different accessories

Product features

- Minimalistic LEDVANCE SCALE design in extruded aluminum housing, available in white and black color



- Includes EVERLOOP: Convenient replacement of light source and LED driver
- Linkable into seamless light line with accessories (surface or pendant mounting)
- Pendant mounting with suspension kit (to be ordered separately)
- Glow Wire Test according to IEC 60695-2-12: 850 °C
- 5-pole terminal block, cable cross section up to 5 x 2.5 mm²
- Lifetime (L80/B10): 70,000 h (at 25 °C)

TECHNICAL DATA

Electrical data

Nominal wattage	52 W / 48 W / 44 W / 39 W
Nominal voltage	220...240 V
Mains frequency	0/50/60 Hz
Nominal current	232...210...200...185 mA
Inrush current	25.2 A
Inrush current time T_{h50}	40 μ s
Max. number of luminaires per miniature circuit breaker B16	29
Max. number of luminaires per miniature circuit breaker C10	23
Max. number of luminaires per miniature circuit breaker C16	38
Power factor λ	≥ 0.90
Total harmonic distortion	≤ 20 %
Protection class	I
Operating mode	Integrated LED driver
Dimming interface	DALI-2 / IoT

Photometrical data

Luminous flux	6400 lm / 6000 lm / 5850 lm / 5250 lm
Luminous efficacy	123 lm/W / 125 lm/W / 133 lm/W / 135 lm/W
Color temperature	4000 K
Light color (designation)	Cool White
Color rendering index Ra	> 90
Standard deviation of color matching	3 sdc _m
Low flicker	Yes
Flickering metric (Pst LM)	≤ 1
Stroboscope effect metric (SVM)	≤ 0.4
Photobiological safety group acc. to EN62778	RG0
Photobiological safety group acc. to EN62471	RG0
Beam angle	90 °
UGR	< 19

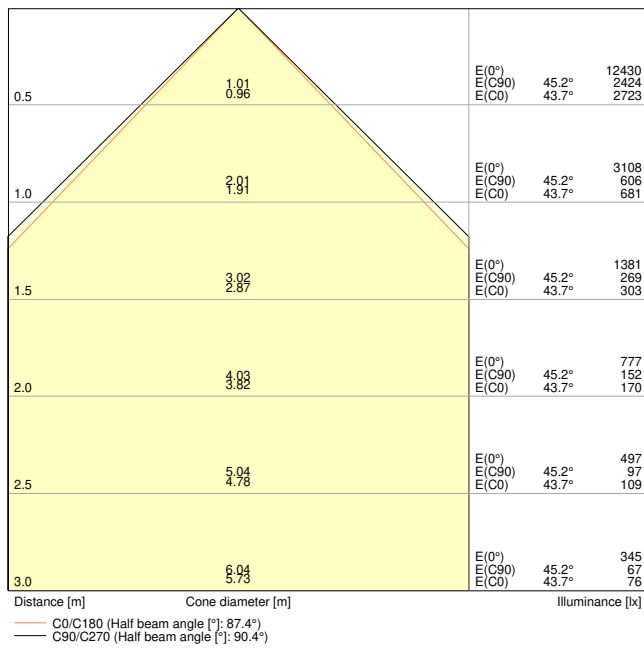

LN INV D 1500 P 52W 940 DAVR WT 1050mA

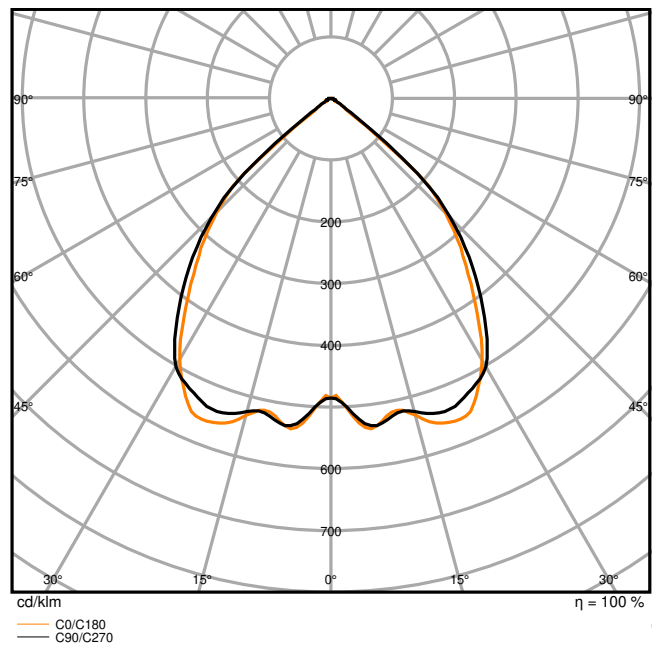

LN INV D 1500 P 52W 940 DAVR WT 1050mA

Dimensions & Weight

Length	1475.00 mm
Width	125.00 mm
Height	43.00 mm
Product weight	3820.00 g

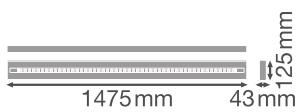

LN INV 1500 P

Materials & Colors

Product color	White
Housing color	White
Body material	Aluminum
Cover material	Polymethylmethacrylate (PMMA)
Light emitting surface material	Polymethylmethacrylate (PMMA)
Glow Wire Test according to IEC 60695-2-12	850 °C
Mercury content	0.0 mg

Application & Mounting

Ambient temperature range	-20...+50 °C
Temperature range at storage	-20...+80 °C
Type of connection	Screwless terminal, 5-Pole (L, N, PE, DA+, DA-)
Type of protection	IP20
Protection class IK (shock resistance)	IK06
Dimmable	Yes
Type of dimming	DALI2
Mounting type	Suspended/Surface
Mounting location	Ceiling
Application environment	Indoor
Adjustable	No
With light source	Yes

Lifespan

Lifespan L70/B50 at 25 °C	100000 h ¹⁾
Lifespan L80/B10 at 25 °C	70000 h ¹⁾
Lifespan L80/B50 at 25 °C	70000 h
Lifespan L90/B10 at 25 °C	35000 h
Number of switching cycles	25000

¹⁾ t[h]: L70 / B50 @ 25 °C (Ta), t[h]: L80 / B10 @ 25 °C (Ta), t[h]: L90 / B10 @ 25 °C (Ta)

Control gear

Output current	1050 mA
ECG - Output ripple current	≤ 3 %
Recommended control gear	OSRAM type OTI DALI 50/220-240/1A4 NFC L

Certificates & Standards

Standards	CE / CB / ENEC / TÜV SÜD / UKCA / EAC / EPD
Luminaire with limited surface temperature, "D sign"	No
Ball shot safe	No
EPD	LEDV-00027-V01.01-EN
Replaceable light source (EPREL)	By the end consumer

Additional product data

Number of illuminants	1
Added function	EVERLOOP / VIVARES / Programmable Multi Lumen

Accessories Optional

Product image	Product name	EAN
	LN INV CORNER CONNECTOR WT	4099854214905
	LN INV SUSPENSION WIRE	4099854215551
	LN INV 1500 THROUGHWIRING KIT	4099854214806
	LN INV INFILL 1500 WT	4099854214844
	LN INV INFILL 600 WT	4099854214882
	LN INV INFILL 1200 WT	4099854214868
	LN INV INLINE CONNECTOR	4099854215612

Product image	Product name	EAN
	LN INV SUSPENSION KIT WT	4099854215537









EQUIPMENT / ACCESSORIES







- Suspension kit available for pendant luminaire version (to be ordered separately)
- Inline, corner and infill connectors available as separate accessory
- Through-wiring cable kit available



Safety advice

- All electrical connections must be made by a qualified person.
- If the external flexible cable or cord of this luminaire is damaged, it shall be exclusively replaced by a qualified person in order to avoid a hazard.
- Caution, risk of electric shock.
- Product in protection class I. All electrically conductive, metallic housing parts that can absorb voltage during operation or during maintenance in the event of a fault must be continuously connected to the protective earthing conductor.

DOWNLOAD DATA

Documents and certificates		Document name
	User instruction / safety instructions	LN INV D PS
	Legal information	LN INV DALI
	Legal information	LSI LN INV DAVR WT
	Legal information	Legal Insert LN INV P DA
	Legal information	Informationstext 18 Abs 4 ElektroG
	Declarations of conformity	LN INV
	Declarations of conformity UKCA	LN INV
Photometric and lighting design files		Document name
	IES file (IES)	LN INV D 1500 P 52W 940 DAVR WT 1050mA

Photometric and lighting design files		Document name
	LDT file (Eulumdat)	LN INV D 1500 P 52W 940 DAVR WT 1050mA
	ULD file (DIALux)	LN INV D 1500 P 52W 940 DAVR WT
	ROLF file (RELUX)	LN INV D 1500 P8 52W 940 DAVR WT
	UGR file (UGR table)	LN INV D 1500 P 52W 940 DAVR WT 1050mA
	Light distribution curve type cone	LN INV D 1500 P 52W 940 DAVR WT 1050mA
	Light distribution curve type polar	LN INV D 1500 P 52W 940 DAVR WT 1050mA

CAD/BIM files		Document name
	BIM Revit 3D	Linear Indiviled G2
	CAD STEP 3D	LN INV D 1500 G2

Tender texts	Document name
	Tender documents LINEAR INDIVILED DIRECT 1500 DALI 1500 P 52W 940 DAVR WT-EN

LOGISTICAL DATA

Product code	Packaging unit (Pieces/Unit)	Dimensions (length x width x height)	Gross weight	Volume
4099854136061	Folding box 1	1,252 mm x 167 mm x 87 mm	4520.00 g	18.19 dm ³
4099854136078	Shipping box 2	1,547 mm x 187 mm x 189 mm	10640.00 g	54.68 dm ³

The mentioned product code describes the smallest quantity unit which can be ordered. One shipping unit can contain one or more single products. When placing an order, for the quantity please enter single or multiples of a shipping unit.

ADDITIONAL CATALOG INFORMATION

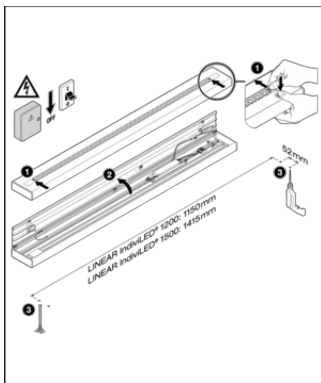

LINEAR InViLED® DIRECT DALI WT	DRIVER	mA	W	lm	lm/W	MC
LN INV D 1200 P 40W 930 DAVR WT	OSRAM	500	35	3150	126	MC
	OTI DALI BV	600	30	3750	125	MC
	250-360 144 NFC L	700	24	4200	120	MC
LN INV D 1200 P 40W 940 DAVR WT	OSRAM	500	35	3210	126	MC
	OTI DALI BV	600	30	3810	127	MC
	250-360 144 NFC L	700	24	4410	123	MC
LN INV D 1500 P 52W 930 DAVR WT	OSRAM	800	40	6840	139	MC
	OTI DALI BV	900	44	8100	139	MC
	250-360 144 NFC L	975	48	8850	137	MC
LN INV D 1500 P 52W 940 DAVR WT	OSRAM	800	39	6900	138	MC
	OTI DALI BV	900	44	8100	139	MC
	250-360 144 NFC L	975	48	8300	129	MC

LINEAR InViLED® DIRECT DALI	DRIVER	mA	W	lm	lm/W	MC
LN INV D 1200 P 40W 930 DAVR WT	OSRAM	500	35	3150	126	MC
	OTI DALI BV	600	30	3750	125	MC
	250-360 144 NFC L	700	24	4200	120	MC
LN INV D 1200 P 40W 940 DAVR WT	OSRAM	500	35	3210	126	MC
	OTI DALI BV	600	30	3810	127	MC
	250-360 144 NFC L	700	24	4410	123	MC
LN INV D 1500 P 52W 930 DAVR WT	OSRAM	800	40	6840	139	MC
	OTI DALI BV	900	44	8100	139	MC
	250-360 144 NFC L	975	48	8850	137	MC
LN INV D 1500 P 52W 940 DAVR WT	OSRAM	800	39	6900	138	MC
	OTI DALI BV	900	44	8100	139	MC
	250-360 144 NFC L	975	48	8300	129	MC

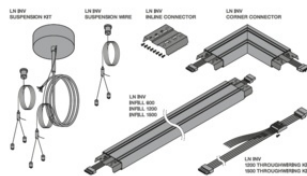
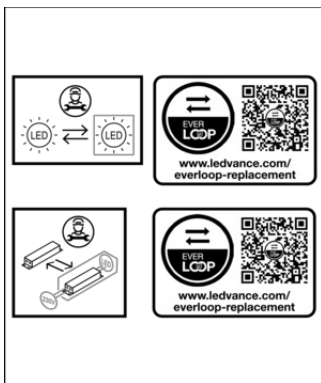

References / Links

– For Guarantee see www.ledvance.com/guarantee

DISCLAIMER

Subject to change without notice. Errors and omission excepted. Always make sure to use the most recent release.