

Selection diagram

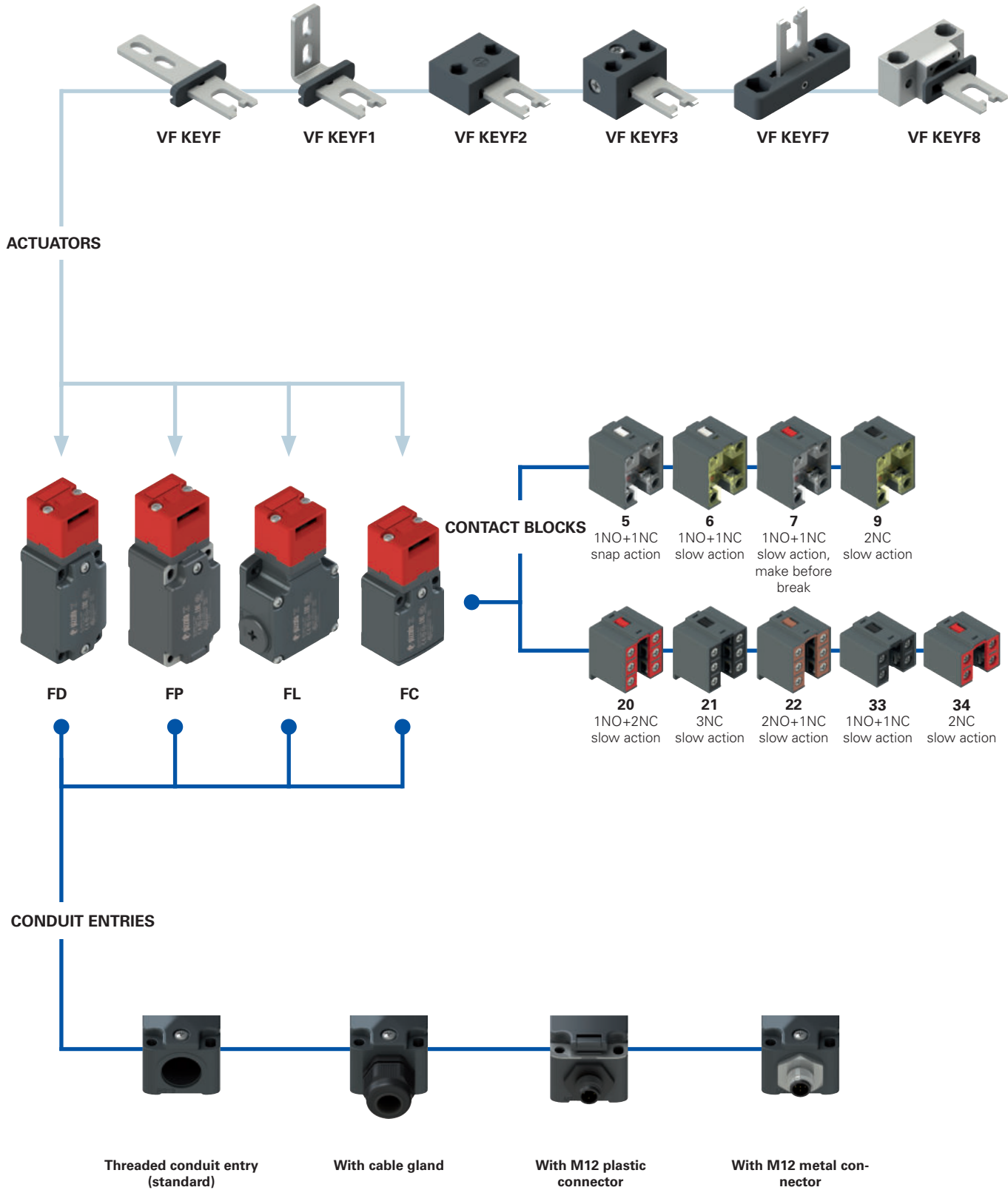



Code structure

Attention! The feasibility of a code number does not mean the effective availability of a product. Please contact our sales office

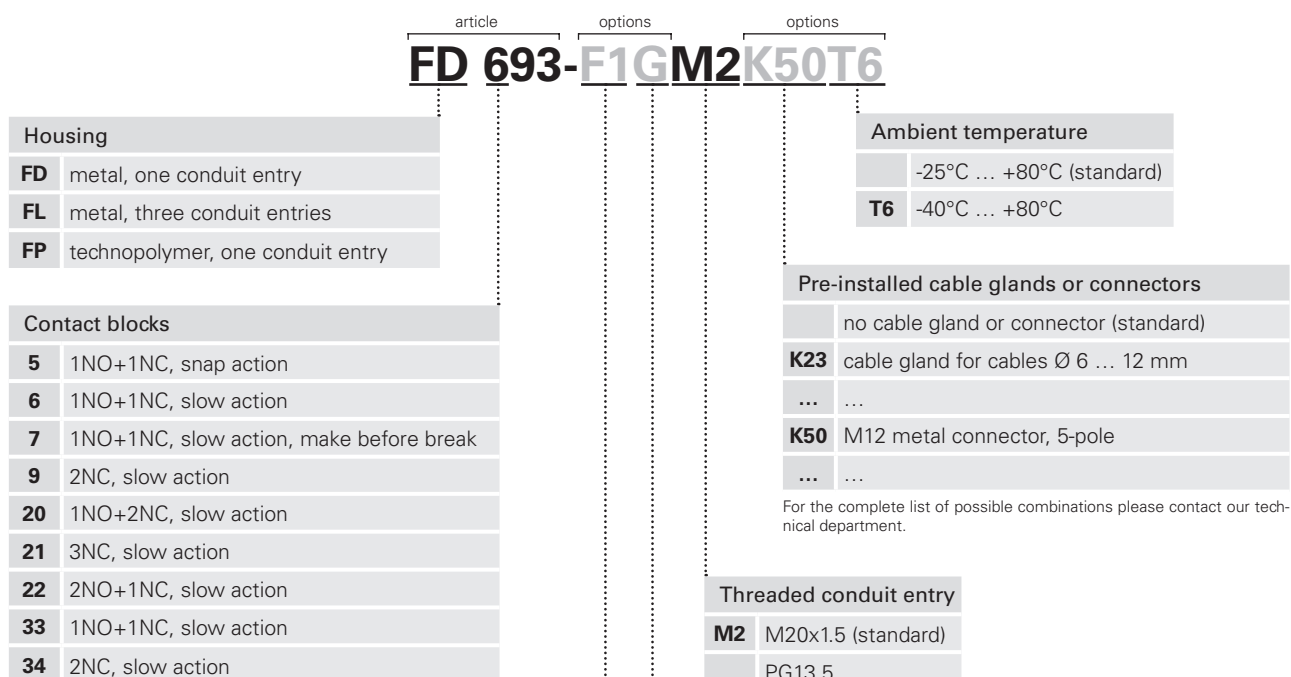

For the complete list of possible combinations please contact our technical department.

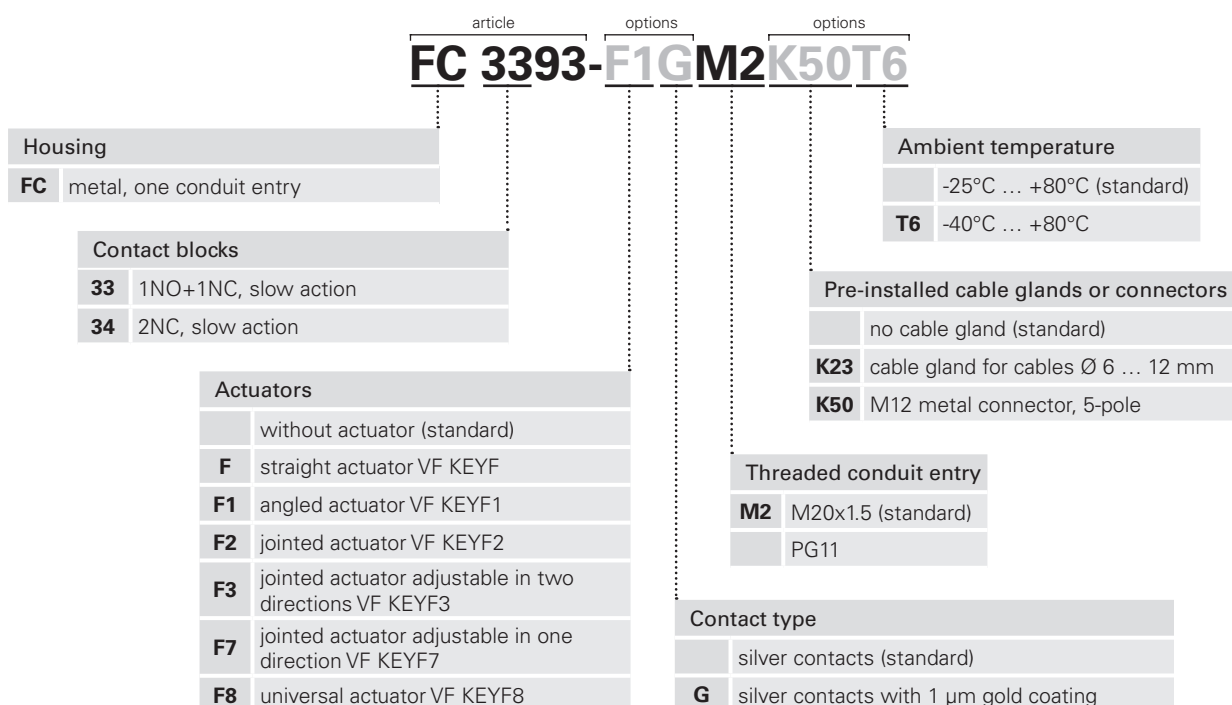

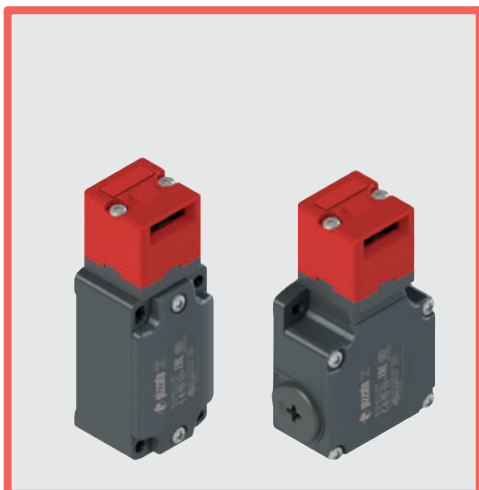

Main features

- Metal housing or technopolymer housing, from one to three conduit entries
- Protection degree IP67
- 9 contact blocks available
- 6 stainless steel actuators available
- Versions with M12 connector
- Versions with gold-plated silver contacts

Quality marks:



IMQ approval:	EG605
UL approval:	E131787
CCC approval:	2021000305000099
EAC approval:	RU C-IT.YT03.B.00035/19

Technical data

Housing

FP series housing made of glass fibre reinforced technopolymer, self-extinguishing, shock-proof and with double insulation:

FD, FL and FC series: metal housing, baked powder coating.

Metal head, baked powder coating.

FD, FP, FC series: one threaded conduit entry: M20x1.5 (standard)

FL series: three threaded conduit entries: M20x1.5 (standard)

Protection degree: IP67 acc. to EN 60529 with cable gland of equal or higher protection degree

General data

SIL (SIL CL) up to:	SIL 3 acc. to EN 62061
Performance Level (PL) up to:	PL e acc. to EN ISO 13849-1
Mechanical interlock, coded:	type 2 acc. to EN ISO 14119
Coding level:	low acc. to EN ISO 14119
Safety parameter B_{10D} :	2,000,000 for NC contacts
Mission time:	20 years
Ambient temperature:	-25°C ... +80°C (standard) -40°C ... +80°C (T6 option)
Max. actuation frequency:	3600 operating cycles/hour
Mechanical endurance:	1 million operating cycles
Max. actuation speed:	0.5 m/s
Min. actuation speed:	1 mm/s
Actuator extraction force:	10 N~
Tightening torques for installation:	see page 441
Wire cross-sections and wire stripping lengths:	see page 461

In compliance with standards:

IEC 60947-5-1, IEC 60947-1, IEC 60204-1, EN ISO 14119, EN ISO 12100, IEC 60529, EN IEC 63000, BG-GS-ET-15, UL 508, CSA C22.2 No. 14.

Approvals:

EN 60947-5-1, UL 508, CSA C22.2 No. 14, GB/T14048.5.

Compliance with the requirements of:

Machinery Directive 2006/42/EC, EMC Directive 2014/30/EU, RoHS Directive 2011/65/EU.

Positive contact opening in conformity with standards:

IEC 60947-5-1, EN 60947-5-1.

⚠ If not expressly indicated in this chapter, for correct installation and utilization of all articles see the instructions given on pages 439 to 454.

	Electrical data	Utilization category
without connector	Thermal current (I_{th}): 10 A Rated insulation voltage (U): 500 Vac 600 Vdc 400 Vac 500 Vdc (contact blocks 20, 21, 22, 33, 34) Rated impulse withstand voltage (U_{imp}): 6 kV 4 kV (contact blocks 20, 21, 22, 33, 34) Conditional short circuit current: 1000 A acc. to EN 60947-5-1 Protection against short circuits: type aM fuse 10 A 500 V Pollution degree: 3	Alternating current: AC15 (50÷60 Hz) U_e (V) 250 400 500 I_e (A) 6 4 1 Direct current: DC13 U_e (V) 24 125 250 I_e (A) 3 0.55 0.3
with M12 connector, 4 or 5-pole	Thermal current (I_{th}): 4 A Rated insulation voltage (U): 250 Vac 300 Vdc Protection against short circuits: type gG fuse 4 A 500 V Pollution degree: 3	Alternating current: AC15 (50÷60 Hz) U_e (V) 24 120 250 I_e (A) 4 4 4 Direct current: DC13 U_e (V) 24 125 250 I_e (A) 3 0.55 0.3
with M12 connector, 8-pole	Thermal current (I_{th}): 2 A Rated insulation voltage (U): 30 Vac 36 Vdc Protection against short circuits: type gG fuse 2 A 500 V Pollution degree: 3	Alternating current: AC15 (50÷60 Hz) U_e (V) 24 I_e (A) 2 Direct current: DC13 U_e (V) 24 I_e (A) 2



Description



These safety switches are ideal for controlling gates, sliding doors and other guards which protect dangerous parts of machines without inertia.

The stainless steel actuator is fastened to the moving part of the guard in such a way that it is separated from the switch each time the guard is opened. A special mechanism ensures that removing the actuator forces the positive opening of the electrical contacts. Easy to install, these switches can be used with all types of guards (with hinge as well as sliding and removable types). The possibility to actuate the switch only with a specific actuator guarantees that the machine can be restarted only after the guard has been closed. These switches are made of robust materials with larger dimensions and are designed especially for heavy gates and harsh environments.

Head with variable orientation

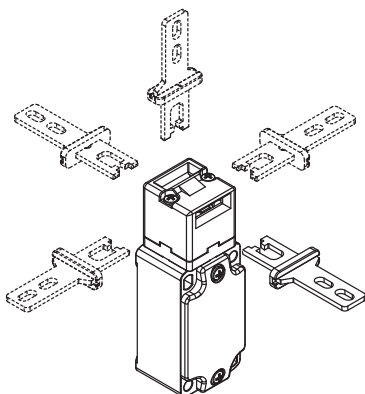

For all switches, the head can be adjusted in 90° steps after removing the two fastening screws. In this way it is possible to actuate the switch from 5 different directions.

Wide-ranging actuator travel

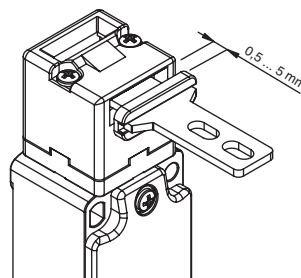

The actuation head of this switch features a wide range of travel. In this way the guard can oscillate along the direction of insertion (4.5 mm) without causing unwanted machine shutdowns. This wide range of travel is available in all actuators in order to ensure maximum device reliability.

Protection degree IP67

IP67

These devices are designed to be used under the toughest environmental conditions, and they pass the IP67 immersion test acc. to EN 60529.

They can therefore be used in all environments where the maximum degree of protection is required for the housing.

Safety screws for actuators

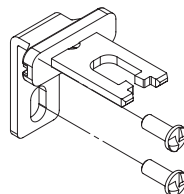

As required by EN ISO 14119, the actuator must be fixed immovably to the guard frame. Pan head safety screws with one-way fitting are available for this purpose. With this screw type, the actuators cannot be removed or tampered by using common tools. See accessories on page 419.

Extended temperature range

-40°C

These devices are also available in a special version suitable for an ambient operating temperature range from -40°C up to +80°C.

They can therefore be used for applications in cold stores, sterilisers and other equipment with low temperature environments. The special materials used to produce these versions retain their characteristics even under these conditions, thereby expanding the installation possibilities.

Laser engraving



All devices are marked using a dedicated indelible laser system. These engravings are therefore suitable for extreme environments too. Thanks to this system that does not use labels, the loss of plate data is prevented and a greater resistance of the marking is achieved over time.

Features approved by IMQ

Rated insulation voltage (Ui):	500 Vac 400 Vac (for contact blocks 2, 11, 12, 20, 21, 22, 28, 29, 30, 33, 34, 37)
Conventional free air thermal current (Ith):	10 A
Protection against short circuits:	type aM fuse 10 A 500 V
Rated impulse withstand voltage (U _{imp}):	6 kV 4 kV (for contact blocks 20, 21, 22, 28, 29, 30, 33, 34) IP67
Protection degree of the housing:	IP67
MV terminals (screw terminals)	
Pollution degree:	3
Utilization category:	AC15
Operating voltage (U _e):	400 Vac (50 Hz)
Operating current (I _e):	3 A
Forms of the contact element:	Za, Za+Za, X+X, Zb, Y+Y, Y+Y+X, Y+Y+Y, Y+X+X, Y, X.
Positive opening of contacts on contact blocks	5, 6, 7, 8, 9, 11, 13, 14, 16, 17, 18, 19, 20, 21, 22, 28, 29, 30, 33, 34, 37, 38, 39, 66.
In compliance with standards:	EN 60947-1, EN 60947-5-1, fundamental requirements of the Low Voltage Directive 2014/35/EU.

Please contact our technical department for the list of approved products.

Features approved by UL

Electrical Ratings:	Q300 pilot duty (69 VA, 125-250 V dc) A600 pilot duty (720 VA, 120-600 V ac)
Environmental Ratings:	Types 1, 4X, 12, 13
	Use 60 or 75 °C copper (Cu) conductor and wire size range 12, 14 AWG, stranded or solid. The terminal tightening torque of 7.1 lb in (0.8 Nm).
	For FP series: the hub is to be connected to the conduit before the hub is connected to the enclosure.

Please contact our technical department for the list of approved products.



Stainless steel actuators

IMPORTANT: These actuators can be used only with items of the FD, FP, FL, FC and FS series (e.g. FD 693-M2).
Low level of coding acc. to EN ISO 14119.

Article	Description
VF KEYF	Straight actuator

Article	Description
VF KEYF1	Angled actuator

Article	Description
VF KEYF2	Jointed actuator

Article	Description
VF KEYF3	Actuator adjustable in two directions

The actuator can flex in four directions for applications where the guard alignment is not precise.

Actuator adjustable in two directions for guards with reduced dimensions.

Article	Description
VF KEYF7	Actuator adjustable in one direction

Actuator adjustable in one direction for guards with reduced dimensions.

Article	Description
VF KEYF8	Universal actuator

Jointed actuator for guards with poor alignment, adjustable in two dimensions for small doors; can be mounted in various positions. The metal fixing body has two pairs of bore holes; it is provided for rotating the working plane of the actuator by 90°.

Accessories

Article	Description
VF KB1	Lock out device

Padlockable lock out device to prevent the actuator entry and the accidental closing of the door behind operators while they are in the danger area.

All values in the drawings are in mm

Accessories See page 419

→ The 2D and 3D files are available at www.pizzato.com