

PRODUCT DATASHEET

LN INV DI 1200 P 55W 930 PS WT

LINEAR INDIVILED DIRECT/INDIRECT 1200 PS | Pendant luminaire for single or light line office application with CRI90 and power select (PS) feature, 1200 mm



Areas of application

- Direct replacement for luminaires with fluorescent lamps
- Offices, education, public buildings
- Single and continuous line configuration
- Direct and indirect lighting

Product benefits

- Easy upgradeability of light source and driver (EVERLOOP design)
- Homogenous light distribution and reduced glare ($UGR \leq 19$) thanks to IndiviLED® optics
- Pendant luminaires with direct light emission (70%) and indirect light emission (30%)
- High performance with CRI90 and up to 133 lm/W
- Highly versatile due to selectable power steps (Power Select - PS) on the driver
- High color consistency with SDCM 3
- Easy installation
- Low flicker light thanks to special electronic control gear
- Multiple mounting options thanks to different accessories

Product features

- Minimalistic LEDVANCE SCALE design in extruded aluminum housing, available in white and black color
- Includes EVERLOOP: Convenient replacement of light source and LED driver
- Linkable into seamless light line with accessories (surface or pendant mounting)



- Pendant mounting with suspension kit (to be ordered separately)
- Glow Wire Test according to IEC 60695-2-12: 850 °C
- 5-pole terminal block, cable cross section up to 5 x 2.5 mm²
- Lifetime (L80/B10): 70,000 h (at 25 °C)

TECHNICAL DATA

Electrical data

Nominal wattage	55 W / 49 W / 43 W / 35.0 W
Nominal voltage	220...240 V
Mains frequency	50...60 Hz
Nominal current	255...227...197...167 mA
Inrush current	15.4 A
Inrush current time T_{h50}	80 μ s
Max. number of luminaires per miniature circuit breaker B16	47
Max. number of luminaires per miniature circuit breaker C10	23
Max. number of luminaires per miniature circuit breaker C16	47
Power factor λ	≥ 0.90
Total harmonic distortion	≤ 20 %
Protection class	I
Operating mode	Integrated LED driver

Photometrical data

Luminous flux	6800 lm / 6050 lm / 5350 lm / 4450 lm
Luminous efficacy	120 lm/W / 122 lm/W / 123 lm/W / 126 lm/W
Color temperature	3000 K
Light color (designation)	Warm White
Color rendering index Ra	> 90
Standard deviation of color matching	3 sdc _m
Low flicker	Yes
Flickering metric (Pst LM)	≤ 1
Stroboscope effect metric (SVM)	≤ 0.4
Photobiological safety group acc. to EN62778	RG0
Photobiological safety group acc. to EN62471	RG0
Beam angle	90 ° + 130 °
UGR	< 19

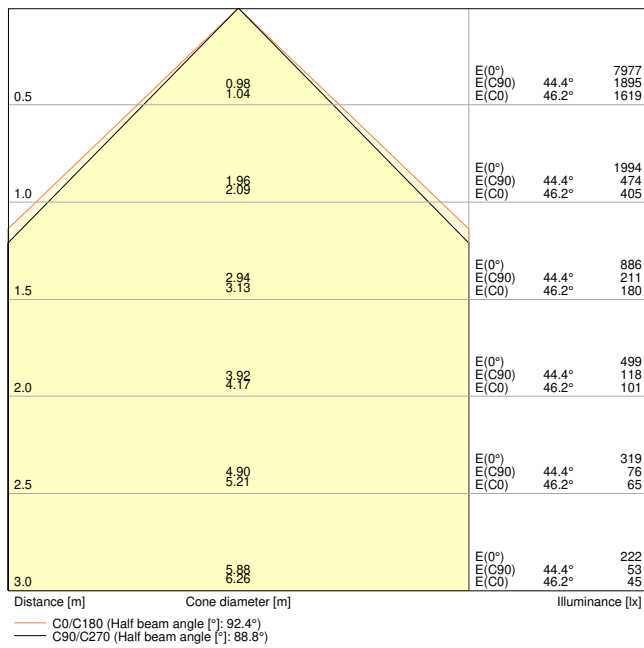

LN INV DI 1200 P 55W 930 PS WT 1100mA

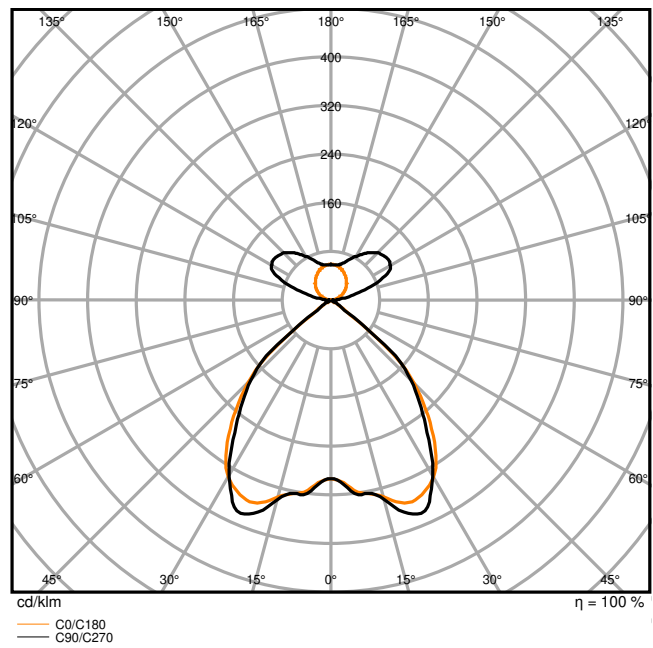

LN INV DI 1200 P 55W 930 PS WT 1100mA

Dimensions & Weight

Length	1210.00 mm
Width	125.00 mm
Height	43.00 mm
Product weight	3700.00 g

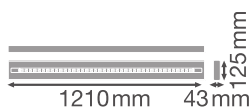

LN INV 1200 P

Materials & Colors

Product color	White
Housing color	White
Body material	Aluminum
Cover material	Polymethylmethacrylate (PMMA)
Light emitting surface material	Polymethylmethacrylate (PMMA)
Glow Wire Test according to IEC 60695-2-12	850 °C
Mercury content	0.0 mg

Application & Mounting

Ambient temperature range	-20...+50 °C
Temperature range at storage	-20...+80 °C
Type of connection	Screwless terminal, 5-Pole (L, N, PE, DA+, DA-)
Type of protection	IP20
Protection class IK (shock resistance)	IK06
Dimmable	No
Mounting type	Suspended
Mounting location	Ceiling
Application environment	Indoor
Adjustable	No
With light source	Yes

Lifespan

Lifespan L70/B50 at 25 °C	100000 h ¹⁾
Lifespan L80/B10 at 25 °C	70000 h ¹⁾
Lifespan L80/B50 at 25 °C	70000 h
Lifespan L90/B10 at 25 °C	35000 h
Number of switching cycles	25000

¹⁾ t[h]: L70 / B50 @ 25 °C (Ta), t[h]: L80 / B10 @ 25 °C (Ta), t[h]: L90 / B10 @ 25 °C (Ta)

Control gear

Output current	800 mA
ECG - Output ripple current	≤ 5 %
Recommended control gear	OSRAM type IT FIT 40/220-240/800 CS L & IT FIT 18/220-240/350 CS L

Certificates & Standards

Standards	CE / CB / ENEC / TÜV SÜD / UKCA / EAC / EPD
-----------	---

Luminaire with limited surface temperature, "D sign"	No
Ball shot safe	No
EPD	LEDV-00026-V01.01-EN
Replaceable light source (EPREL)	By the end consumer



Additional product data



Number of illuminants	2
Added function	EVERLOOP / MULTI SELECT

Accessories Mandatory

Product image	Product name	EAN
	LN INV SUSPENSION KIT WT	4099854215537

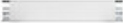
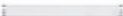
Accessories Optional









Product image	Product name	EAN
	LN INV CORNER CONNECTOR WT	4099854214905
	LN INV 1200 THROUGHWIRING KIT	4099854214820
	LN INV INFILL 1500 WT	4099854214844
	LN INV INFILL 600 WT	4099854214882
	LN INV INFILL 1200 WT	4099854214868









Product image	Product name	EAN
	LN INV INLINE CONNECTOR	4099854215612
	LN INV SUSPENSION WIRE	4099854323980

EQUIPMENT / ACCESSORIES

- Suspension kit available for pendant luminaire version (to be ordered separately)
- Inline, corner and infill connectors available as separate accessory
- Through-wiring cable kit available

DOWNLOAD DATA

Documents and certificates		Document name
	User instruction / safety instructions	LN INV
	Legal information	LN INV PS
	Legal information	LSI LN INDIVILED
	Legal information	Legal Insert LN INV P PS
	Legal information	Informationstext 18 Abs 4 ElektroG
	Declarations of conformity	LN INV
	Declarations of conformity UKCA	LN INV
Photometric and lighting design files		Document name
	IES file (IES)	LN INV DI 1200 P 55W 930 PS WT 1100mA
	LDT file (Eulumdat)	LN INV DI 1200 P 55W 930 PS WT 1100mA

Photometric and lighting design files		Document name
	ULD file (DIALux)	LN INV DI 1200 P 55W 930 PS WT
	ROLF file (RELUX)	LN INV DI 1200 P 55W 930 PS WT
	UGR file (UGR table)	LN INV DI 1200 P 55W 930 PS WT 1100mA
	Light distribution curve type cone	LN INV DI 1200 P 55W 930 PS WT 1100mA
	Light distribution curve type polar	LN INV DI 1200 P 55W 930 PS WT 1100mA
CAD/BIM files		Document name
	BIM Revit 3D	Linear Indiviled G2
	CAD STEP 3D	LN INV D I 1200 G2
Tender texts	Document name	
	Tender documents	LINEAR INDIVILED DIRECTINDIRECT 1200 PS 1200 P 55W 930 PS WT-EN

LOGISTICAL DATA

Product code	Packaging unit (Pieces/Unit)	Dimensions (length x width x height)	Gross weight	Volume
4099854135156	Folding box 1	178 mm x 1,263 mm x 103 mm	4300.00 g	23.16 dm ³
4099854135163	Shipping box 2	1,277 mm x 187 mm x 189 mm	10000.00 g	45.13 dm ³

The mentioned product code describes the smallest quantity unit which can be ordered. One shipping unit can contain one or more single products. When placing an order, for the quantity please enter single or multiples of a shipping unit.

ADDITIONAL CATALOG INFORMATION

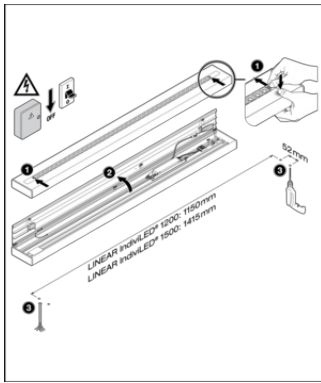

LINEAR KNOWLEDGE 1500: 1150mm	DRIVER	150 WATT				225 WATT				300 WATT				Total	
		Power	Length	LEDs	Watt	Power	Length	LEDs	Watt	Power	Length	LEDs	Watt	Watt	Length
LINEAR KNOWLEDGE 1500: 1150mm	DRIVER	150 WATT	1500 mm	1150 mm	1150	225 WATT	2250 mm	1150 mm	1150	300 WATT	3000 mm	1150 mm	1150	675	3300
LINEAR KNOWLEDGE 1500: 1450mm	DRIVER	150 WATT	1500 mm	1450 mm	1450	225 WATT	2250 mm	1450 mm	1450	300 WATT	3000 mm	1450 mm	1450	675	3300
LINEAR KNOWLEDGE 1500: 1450mm	DRIVER	150 WATT	1500 mm	1450 mm	1450	225 WATT	2250 mm	1450 mm	1450	300 WATT	3000 mm	1450 mm	1450	675	3300
LINEAR KNOWLEDGE 1500: 1450mm	DRIVER	150 WATT	1500 mm	1450 mm	1450	225 WATT	2250 mm	1450 mm	1450	300 WATT	3000 mm	1450 mm	1450	675	3300

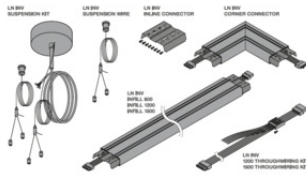
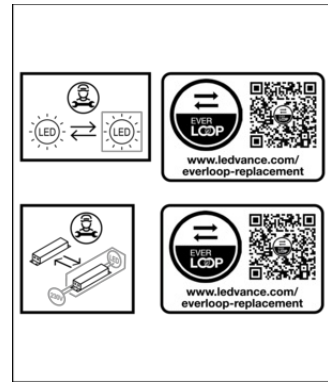

LINEAR KNOWLEDGE 1500: 1150mm	DRIVER	150 WATT				225 WATT				300 WATT				Total	
		Power	Length	LEDs	Watt	Power	Length	LEDs	Watt	Power	Length	LEDs	Watt	Watt	Length
LINEAR KNOWLEDGE 1500: 1150mm	DRIVER	150 WATT	1500 mm	1150 mm	1150	225 WATT	2250 mm	1150 mm	1150	300 WATT	3000 mm	1150 mm	1150	675	3300
LINEAR KNOWLEDGE 1500: 1450mm	DRIVER	150 WATT	1500 mm	1450 mm	1450	225 WATT	2250 mm	1450 mm	1450	300 WATT	3000 mm	1450 mm	1450	675	3300
LINEAR KNOWLEDGE 1500: 1450mm	DRIVER	150 WATT	1500 mm	1450 mm	1450	225 WATT	2250 mm	1450 mm	1450	300 WATT	3000 mm	1450 mm	1450	675	3300
LINEAR KNOWLEDGE 1500: 1450mm	DRIVER	150 WATT	1500 mm	1450 mm	1450	225 WATT	2250 mm	1450 mm	1450	300 WATT	3000 mm	1450 mm	1450	675	3300

References / Links

- For Guarantee see www.ledvance.com/guarantee

DISCLAIMER

Subject to change without notice. Errors and omission excepted. Always make sure to use the most recent release.