

### Push-button plus with room temperature control unit

Operating instructions

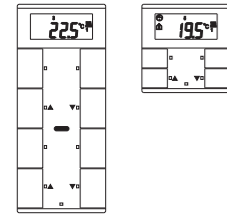

#### System M

**Push-button, 2-gang plus with room temperature control unit**  
Art. no. MTN6212-03../MTN6212-04..

#### System M

**Push-button, 4-gang plus with room temperature control unit**  
Art. no. MTN6214-03../MTN6214-04..

### Necessary accessories

- You have to complete the 2-gang push-button plus with a design frame system M.
- You have to complete the 2-gang push-button plus with a design frame system M without central bridge piece (Art. no MTN4788..., MTN4858..., MTN4868..., MTN4878..., MTN5158..., MTN4888).

### For your safety

**DANGER**  
**Risk of fatal injury from electrical current.**  
The unit may only be installed and connected by skilled electricians. Observe the regulations valid in the country of use, as well as the valid KNX guidelines.

### Getting to know the push-button

The **push-button plus with room temperature control unit** (referred to below as the **push-button**) gives you four (push-button 2-gang) or eight (push-button 4-gang) operating surfaces. The keys can be set individually to perform various functions. Furthermore a room temperature control unit is integrated, which allows you to control temperature in various different ways.

#### Functions of the push-button:

- Switching, toggling, dimming, blind control
- Szenenfunktion
- Communication and disable functions
- Time control with synchronisation, reading external temperature, fan control

#### Functions of the room temperature control unit:

- Heating/cooling with 1 controller output
- Heating/cooling with separated controller outputs
- Heating/cooling with 2 controller outputs

The push-button can directly be connected to the KNX and is parameterised by the electrical installer via the KNX-Tool-Software (ETS).

### Scope of delivery

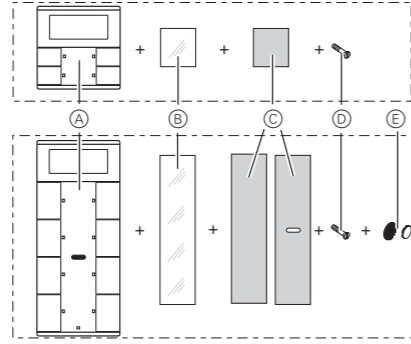

- A Push-button
- B Cover
- C Foil strip
- D Safty screw
- E Sticker (only push-button 4-gang)

### Connections, displays and operating elements

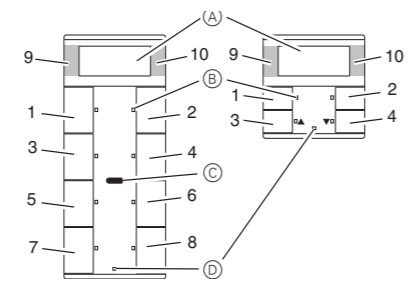

- 1 - 8: Function keys
- 9 + 10: Function keys for display
- A Display
- B LED
- C IR receiver
- D Staus LED

### Getting to know the keypad

The push-buttons opposite each other can be configured as either individual push-buttons or a push-button pair. The push-buttons are programmed with various functions depending on the pre-setting.

For 4-gang push-button only:

The 4-gang push-button is equipped with an IR receiver, with which you can control the push-button with any IR remote control. Pressing push-buttons 1-8 on the remote control activates the function of the corresponding push-button. Push-buttons 9 and 10 of the remote control have a direct effect on display push-buttons 9 and 10.

### Mounting side

In order for the integrated room temperature control unit to work in the best way, you should keep in mind the following when selecting the right installation side:

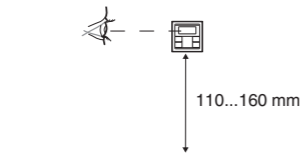
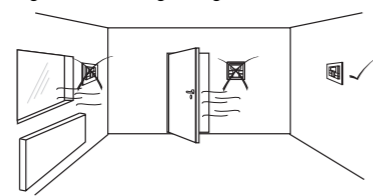

### Sources of interference

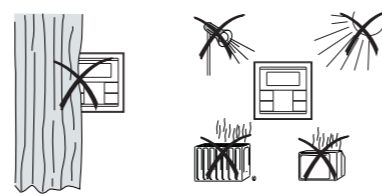

### Mounting the push-button

#### Push-button 2-gang and 4-gang

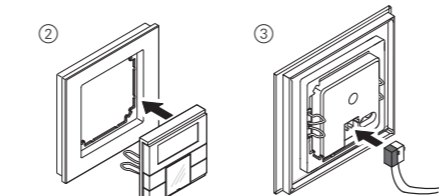
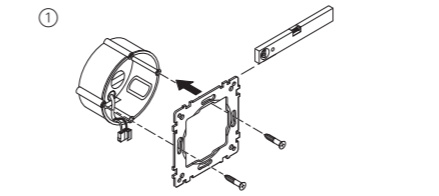

#### Only push-button 4-gang

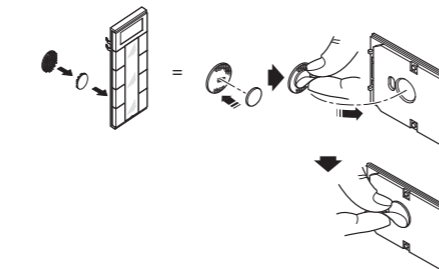

### Operating the push-button

- 1 Set the push-button to programming state

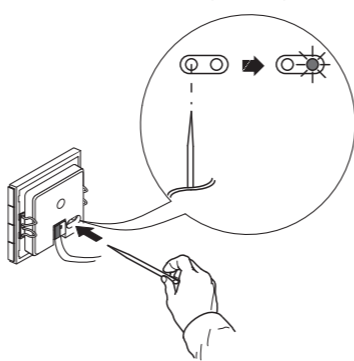

- 2 Load the physical address and application from the ETS into the push-button: The red programming LED goes out.

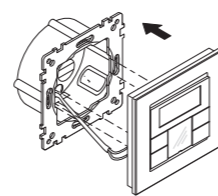

**Note for the electrician**  
Make sure that you note the settings you have made in the ETS which are important for the user in the configuration table (see „Pre-settings table“), because not all parameters that can be set are shown in the display of the push-button.

### Anti-theft protection

#### Push-button 2-gang and 4-gang

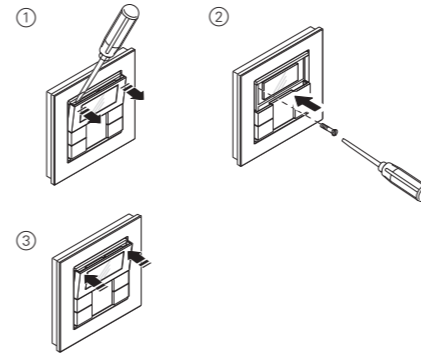

### Dismantling the push-button

**CAUTION**  
**The device could become damaged.**  
Before removing the push-button, check whether it is secured with protection against theft. Always remove the protection against theft before removing the push-button.

### Labelling the push-button

#### Opening the labelling field

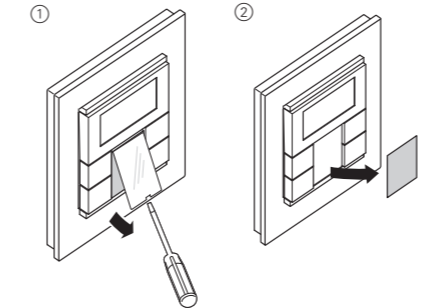

#### Creating labelled foil strips

You can also create and print corresponding foil strip templates with any layout program.

Size specifications for foils (in mm):

Push-button	Height	Width	Thickness
2-gang	24,9	23	max. 0,15
4-gang	96,2	23	max. 0,15

Consult the operating instructions of your printer to find out which type of foil strips you can print.

**i** Only use the coloured foil strips enclosed as the base, since this ensures that the push-button LEDs under the labelling field can shine through.

**i** Two versions of coloured foil strips are provided: one with a recess in the middle for the IR receiver, and one without a recess. If you want to control the push-button via an IR remote control, you have to use the coloured foil strip with recess. Always only use one of the two coloured foil strips.

#### Closing the labelling field

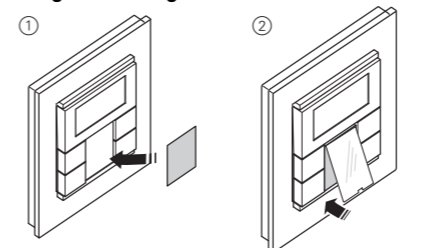

### Pre-settings

When installing the push-button, the electrician defines various settings that are necessary so you can use the push-button correctly. Most of the explanations provided on the following pages depend on these settings. The electrician enters the settings in question in a table for you (see table „pre-settings“).

**i** If you come across this symbol when reading, it means that you can look up the corresponding value in the table.

### Preface room temperature control unit/display

With the integrated room temperature control unit, you can control the temperature in various different ways.

You can read and set important information on the display:

- Setpoint temperature
- Operating mode (comfort, standby, night, etc.)
- Working day/holiday
- Display mode (setpoint temperature, actual temperature, date etc.)
- Background lighting
- Setting the time/switching time

### Getting to know the display

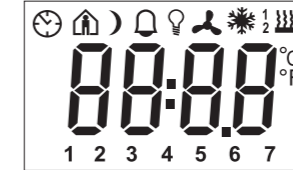

You will see the following symbols on the display:

Comfort mode or working day. The room temperature is adjusted to the set comfort setpoint temperature .

The flashing symbol means that the comfort extension is active.

Standby mode or holiday. The room temperature is adjusted to the set standby setpoint temperature .

Night operation. The room temperature is adjusted to the set night setpoint temperature .

Time control is active.

Constant display: The time has been synchronised.

Flashing display: The time has not been synchronised; the displayed time may not be accurate.

Alarm, symbol flashing. For 4-gang push-button: Additional acoustic warning sound possible .

**1 2 3 4**  
**5 6 7** Weekday display .  
In combination with : Fan speed

Menu command „Setting the background lighting“ is activated.  
Fan.

Heating control mode is active or controller requires power.

Cooling control mode is active or controller requires power.

Display under „Heating“ or „Cooling“ symbol.  
- For heating **or** cooling:  
„1“: Setpoint temperature has not yet been reached. The controller is heating or cooling.  
„2“: Level 2 is activated (display only if two-stage heating/cooling is set).  
- For heating **and** cooling: Two modes are available: Manual or automatic

°C Temperature display in degrees Celsius

°F Temperature display in degrees Fahrenheit

**88:88** Time display or value display

### Getting to know the control menu

There is a control menu for selecting the individual functions of the room temperature controller.

A rocker is integrated in the cover of the display. It has three contacts: left, centre and right. With these push-buttons, you can access the control menu, scroll backwards and forwards and change individual values.

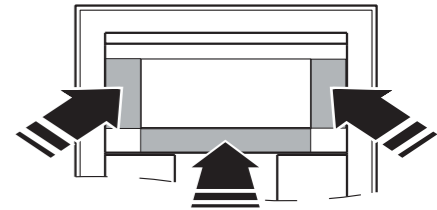

### Overview of the menu structure

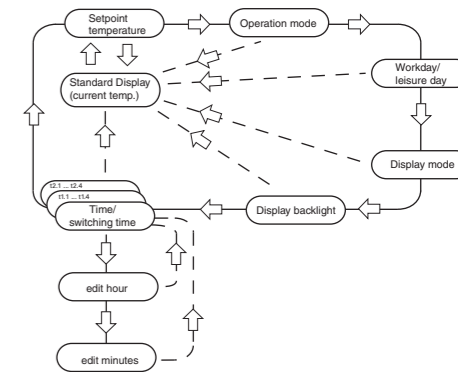

Push-button action	Function triggered
Center - Long push-button action*	Select menu Save Return to standard display

Center - Short push-button action**	Select next menu command
--	--------------------------

Left/Right - Short push-button action**	Change value
--	--------------

\*Long push-button action = approx. 5 s

\*\*Short push-button action = approx. 1 s

**i** If you don't press any push-button within a period of about one minute, the room temperature control unit automatically returns to the standard display. The values that were set before the control menu was opened are restored; **any changes that you may have made are not saved. Exception: The temperature is saved directly.**

## Setting the room temperature control unit/display view

### Standard display

Here you see an example of the standard display:



- „Comfort“ operating mode
- Actual temperature 20°
- Heating is active in order to reach the comfort setpoint temperature.
- is constantly displayed: The time has been synchronised with the time switch (e.g. year time switch REG-K). Clock symbol flashes: The time has not (yet) been synchronised.
- Weekday display 3 = Wednesday

Note that the display of the weekday depends on the pre-settings. The electrician has set a specific weekday to 1. In some countries the first day of the week is not Monday, but Sunday, for example. The other numbers have different meanings accordingly (e.g., 2 = Monday, 3 = Tuesday etc.).

### Setting the setpoint temperature

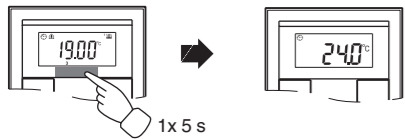

The electrician has specified three setpoint temperatures ( for both heating and cooling):

- for comfort mode
- for standby mode
- for night operation

You see the setpoint temperature of the current operating mode. You can only change this setpoint temperature. In order to change the setpoint temperature of another operating mode, you first have to switch the operating mode (see „Setting the operating mode“).

The electrician specified , within which limits this value can be changed (for example, within a minimum of 16 °C up to a maximum of 26 °C). You cannot set any value below or above these limit values. If the electrician made the appropriate setting , the 4-gang push-button emits a warning sound as soon as you attempt to exceed these limit values.

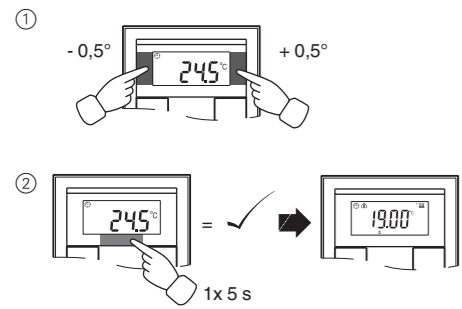

### Setting the operating mode

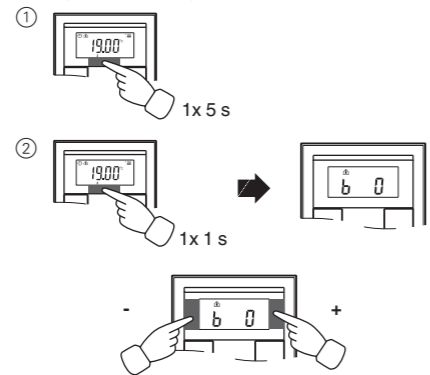

- b 0 = comfort mode Select this operating mode if you are staying in the room. The heating is set to the comfort setpoint temperature (e.g. 21 °C).
- b 1 = standby mode Select this operating mode when you are not in the room over a longer period of time. The heating is set to the standby setpoint temperature (e.g. 18 °C).
- b 2 = night operation The heating is set to the night setpoint temperature (e.g. 15 °C).
- b 3 = comfort extension (flashes) Select this operating mode if you want to suppress night operation temporarily. The heating is set to the comfort setpoint temperature (e.g. 21 °C).

The electrician may have set , the times at which the operating mode switches automatically from night operation to comfort mode and vice versa.

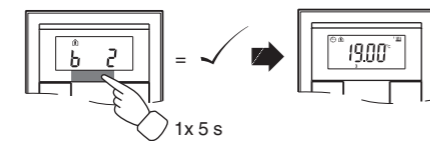

### Setting the working day/holiday

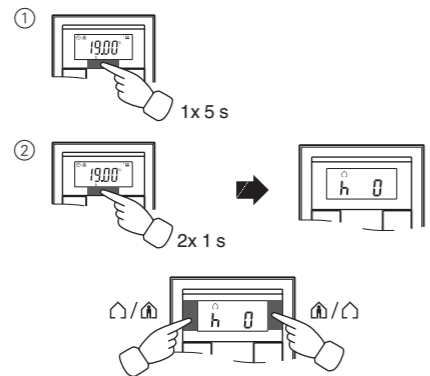

- h 0 = holiday
- h 1 = working day

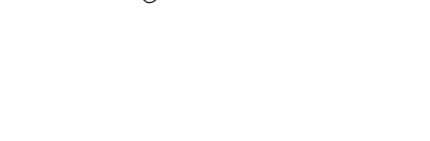

### Setting the display mode

With the display mode, you can select which values you want to see in the display.

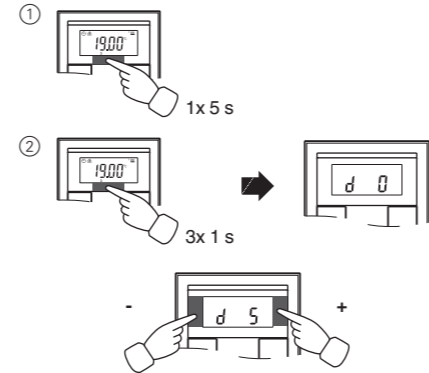

- d 0 = actual temperature (without decimal point)
- d 1 = setpoint temperature (to 0.5 degree accuracy)
- d 2 = temperature from external temperature sensor
- d 3 = date
- d 4 = time
- d 5 = fan speed
- d 6 = date and time in alternation
- d 7 = date, time and fan speed in alternation
- d 8 = actual and setpoint temperature in alternation
- d 9 = actual/setpoint temperature and time in alternation
- d 10 = actual/setpoint temperature and fan speed in alternation
- d 11 = temperature from external temperature sensor and actual temperature
- d 12 = temperature from external temperature sensor, actual temperature and time in alternation
- d 13 = actual/setpoint temperature, date and time in alternation
- d 14 = actual/setpoint temperature, fan speed and time in alternation
- d 15 = emperature from external temperature sensor, actual temperature, fan speed and time in alternation

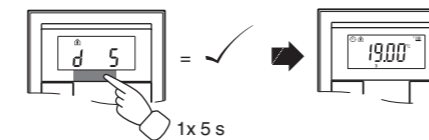

### Setting the background lighting

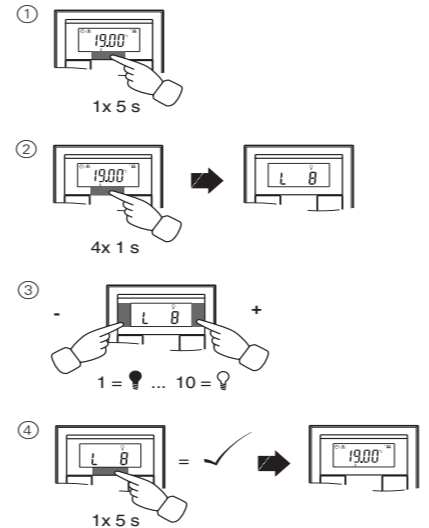

### Setting the internal clock time and switching times

If the time is updated by an external time switch, the updated time is displayed here. If you change this time manually, it will be overwritten again by the time switch during the next update.

You can only use the control menu to adjust the switching times which have been pre-programmed via the ETS. Switching times which are not defined in the ETS are shown when they are called up in the display with „-:“ and cannot be set using the push-buttons on the display.

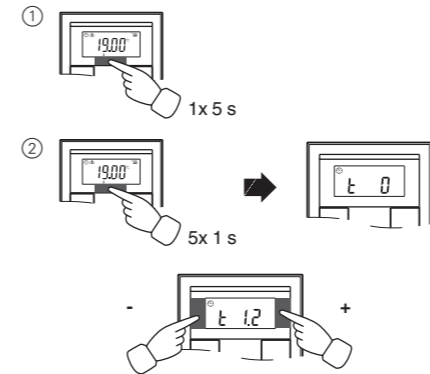

- t 0 = time (either transmitted from the external time switch or from the internal clock)
- t 1.1 bis t 1.4 = time channel 1, switching time 1-4
- t 2.1 bis t 2.4 = time channel 2, switching time 1-4
- ③ Press central push-button and **hold** : the hour display for the selected time/switching time starts to flash.
- ④ Press the left or right push-button on the display: Set the hours as desired
- ⑤ Press the central push-button **briefly** : The minute digits now flash.
- ⑥ Press the left or right push-button on the display: Set the minutes as desired.
- ⑦ Press the central push-button **briefly** : The set time (t...) appears again.
- ⑧ Press the central push-button **briefly** again: Save the desired new setting.

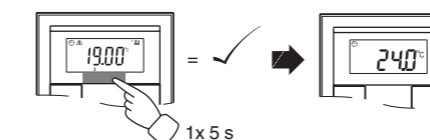

Synchronise the time via an external time switch to guarantee precision over a long period of time.

### Selecting the setpoint temperature or operating mode directly

The electrician specified , whether you can access and adjust the setpoint temperature or the operating mode directly using the right/left push-button, or whether none of these functions is activated.

- ① 1 x push-button **left/right** – **short** push-button action.

The menu command „Set setpoint temperature“ or „Set operating mode“ is displayed with the last set value. Change the value by pressing the left or right push-button on the display. The value is saved directly; you don't have to save it separately. After approx. 5 s, the room temperature control unit returns automatically to the standard display.

## Other display views

- APL. Application not loaded or faulty
- E 2 Heating setpoint temperature = cooling setpoint temperature
- E 3 ETS application is not compatible
- E 4 Upper control value range = lower control value range
- E 5 FRAM error
- E 6 Error in temperature sensor
- E 7 STACK error
- E 8 RAM error
- E 9 Buffer error

## Presettings table

### Push-button assignment

Push-button 1	_____
Push-button 2	_____
Push-button 3	_____
Push-button 4	_____
Push-button 5	_____
Push-button 6	_____
Push-button 7	_____
Push-button 8	_____

### Time control channel 1

Switching	1	2	3	4
Time	_: _:	_: _:	_: _:	_: _:
Function:	_____	_____	_____	_____

### Time control channel 2

Switching	1	2	3	4
Time	_: _:	_: _:	_: _:	_: _:
Function:	_____	_____	_____	_____

### Alarm functions

- Alarm sounds if actual temperature is less than the frost protection temperature **or**
- Alarm sounds if the setpoint adjustment limit is exceeded
- Others: \_\_\_\_\_

Heating setpoints in °C/°F	Adjustment limit in °C/°F
Comfort: _____	min: _____ max: _____
Standby: _____	min: _____ max: _____
Night: _____	min: _____ max: _____

Heating setpoints in °C/°F	Adjustment limit in °C/°F
Comfort: _____	min: _____ max: _____
Standby: _____	min: _____ max: _____
Night: _____	min: _____ max: _____
Frost protection: _____	min: _____ max: _____
Heat protection: _____	min: _____ max: _____

### Setpoint adjustment valid until:

Operation mode change / Permanent

**Week starts (1):** on Fri / Sat / Sun / Mon

**Direct selection:** Setpoint temperature / Operation mode / None

## Technical data

- Power supply: via KNX
- Connection: Bus connecting terminal
- Display elements
- Push-button
- 2-/4-gang: 1x Display
- 1x operational LED
- Push-button 2-gang: 4x Status LED
- Push-button 4-gang: 8x Status LED
- Piezo buzzer

### Operating elements

- Push-button
- 2-/4-gang: 3 push-buttons to navigate menu
- Push-button 2-gang: 4 push-buttons
- Push-button 4-gang: 8 push-buttons
- IR receiver (angle of reception: 60°)

Measuring range: 0 to 40 °C

Measuring accuracy: ± 1 K, depending on installation site; Offset can be configured

Controller type: 2-step

Controller mode: Heating with 1 controller output

Cooling with 1 controller output

Heating with 2 controller outputs

Cooling with 2 controller outputs

Heating and cooling with separate controller outputs

2-step heating with 2 controller outputs

2-step cooling with 2 controller outputs

2-step heating and 2-step cooling with 4 control outputs

Type of protection: IP 20

## Schneider Electric Industries SAS

If you have technical questions, please contact the Customer Care Center in your country.

www.schneider-electric.com

This product must be installed, connected and used in compliance with prevailing standards and/or installation regulations. As standards, specifications and designs develop from time to time, always ask for confirmation of the information given in this publication.