

# COMO CS

Manual Cam Transfer Switches  
from 25 to 100 A



COMO CS - Door mounting  
I-II 3 P 25 A



COMO CS in enclosure  
I-0-II 3 P 40 A

### The solution for

- > Industry (machine control)



### Strong points

- > Simple installation
- > Quick mounting
- > Effective in all circumstances

### Compliance with standards

- > IEC 60947-3



- > UL 60947-4-1



\* cULus under certification.

## Function

COMO CS are manually operated multi-pole transfer switches. They ensure switching, transfer of sources or transfer of two low voltage circuits on load as well as their safe disconnection.

## Advantages

### Simple installation

The "quick fix" allows significant time saving in fixing the handle to the device. The devices sold in enclosed version are ready for installation.

### Quick mounting

The accessories offered are common to all the products in the range. The products are designed for installation:

- on the rear of the cabinet on a backplate,
- on the rear of the cabinet on a DIN rail,
- on the door with a direct handle.

### Effective in all circumstances

The devices are available with 3 standard switching types that can cover a wide variety of applications:

- I-II
- I-0-II
- I-0-II with bypass

Please consult us for adaptations to specific wiring diagrams.

## Configurations

### Backplate switch mounted with external handle

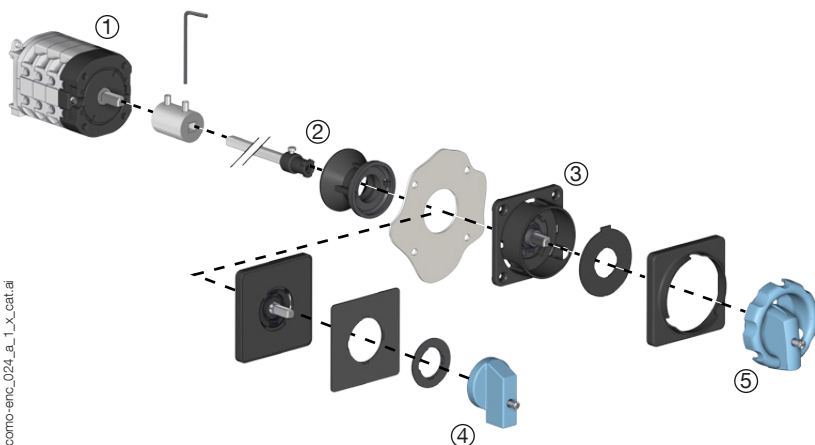

Functional diagram (for further details see the installation instructions supplied with the product).  
1. Shaft extension

- 2. Shaft guide
- 3. Signalling plate
- 4. Non padlockable handle

### Direct quickfixing handle for door or backplate mounted switch

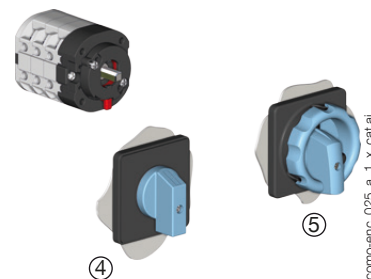

- 5. Padlockable handle

## References

### COMO CS

#### Backplate mounting with direct quickfixing handles or external handles

Rating (A)	N° of poles	Switching type	Switch body rear mounting <sup>(1)</sup>	Padlockable direct quick fixing handle	Non-padlockable direct quick fixing handle	Padlockable external handle <sup>(2)</sup>	Non-padlockable external handle <sup>(2)</sup>
25 A	3 P	I - II	4320 <b>3002</b>	Blue/Black 4359 <b>3042</b>  Red/Yellow 4359 <b>3043</b>	Blue/Black 4359 <b>3022</b>	Blue/Black 4359 <b>1042</b>  Red/Yellow 4359 <b>1043</b>	Blue/Black 4359 <b>2022</b>
	4 P	I - II	4320 <b>4002</b>				
	3 P	I - 0 - II	4330 <b>3002</b>				
	4 P	I - 0 - II	4330 <b>4002</b>				
	3 P	Bypass I - 0 - II	4350 <b>3002</b>				
	4 P	Bypass I - 0 - II	4350 <b>4002</b>				
40 A	3 P	I - II	4320 <b>3004</b>				
	4 P	I - II	4320 <b>4004</b>				
	3 P	I - 0 - II	4330 <b>3004</b>				
	4 P	I - 0 - II	4330 <b>4004</b>				
	3 P	Bypass I - 0 - II	4350 <b>3004</b>				
	4 P	Bypass I - 0 - II	4350 <b>4004</b>				
63 A	3 P	I - II	4320 <b>3006</b>				
	4 P	I - II	4320 <b>4006</b>				
	3 P	I - 0 - II	4330 <b>3006</b>				
	4 P	I - 0 - II	4330 <b>4006</b>				
	3 P	Bypass I - 0 - II	4350 <b>3006</b>				
	4 P	Bypass I - 0 - II	4350 <b>4006</b>				
100 A	3 P	I - II	4320 <b>3010</b>				
	4 P	I - II	4320 <b>4010</b>				
	3 P	I - 0 - II	4330 <b>3010</b>				
	4 P	I - 0 - II	4330 <b>4010</b>				
	3 P	Bypass I - 0 - II	4350 <b>3010</b>				
	4 P	Bypass I - 0 - II	4350 <b>4010</b>				

(1) Mounting on DIN rail and backplate from 25 to 40 A and mounting on backplate for ratings from 63 to 100 A.

(2) Delivered with shaft and plate for front external control.

#### Door mounting with direct quickfixing handles

Rating (A)	N° of poles	Switching type	Switch body mounting on door	Padlockable direct quick fixing handle	Non-padlockable direct quick fixing handle
25 A	3 P	I - II	4320 <b>3102</b>	Blue/Black 4359 <b>3042</b>  Red/Yellow 4359 <b>3043</b>	Blue/Black 4359 <b>3022</b>
	4 P	I - II	4320 <b>4102</b>		
	3 P	I - 0 - II	4330 <b>3102</b>		
	4 P	I - 0 - II	4330 <b>4102</b>		
	3 P	Bypass I - 0 - II	4350 <b>3102</b>		
	4 P	Bypass I - 0 - II	4350 <b>4102</b>		
40 A	3 P	I - II	4320 <b>3104</b>		
	4 P	I - II	4320 <b>4104</b>		
	3 P	I - 0 - II	4330 <b>3104</b>		
	4 P	I - 0 - II	4330 <b>4104</b>		
	3 P	Bypass I - 0 - II	4350 <b>3104</b>		
	4 P	Bypass I - 0 - II	4350 <b>4104</b>		
63 A	3 P	I - II	4320 <b>3106</b>		
	4 P	I - II	4320 <b>4106</b>		
	3 P	I - 0 - II	4330 <b>3106</b>		
	4 P	I - 0 - II	4330 <b>4106</b>		
	3 P	Bypass I - 0 - II	4350 <b>3106</b>		
	4 P	Bypass I - 0 - II	4350 <b>4106</b>		
100 A	3 P	I - II	4320 <b>3110</b>		
	4 P	I - II	4320 <b>4110</b>		
	3 P	I - 0 - II	4330 <b>3110</b>		
	4 P	I - 0 - II	4330 <b>4110</b>		
	3 P	Bypass I - 0 - II	4350 <b>3110</b>		
	4 P	Bypass I - 0 - II	4350 <b>4110</b>		

### Other solutions with enclosures

#### General characteristics



como-enc\_019.eps

Available for switching types I-II and I-0-II

- Different enclosure sizes adapted to your needs.
- Maximum safety during maintenance operations due to triple padlocking of the handle in position 0 (position I for switching type I-II).
- IP 65 / NEMA 4, 4X : When installed in an industrial environment, protection degree IP 65 and NEMA 4, 4X ensures that the products are protected against dust and water jets.
- Red-yellow operating handle.

#### References

Rating (A)	No. of poles	Switching type	Reference
25 A	3 P	I - II	4321 <b>3C02</b>
	4 P	I - II	4321 <b>4C02</b>
	3 P	I - 0 - II	4331 <b>3C02</b>
	4 P	I - 0 - II	4331 <b>4C02</b>
40 A	3 P	I - II	4321 <b>3C04</b>
	4 P	I - II	4321 <b>4C04</b>
	3 P	I - 0 - II	4331 <b>3C04</b>
	4 P	I - 0 - II	4331 <b>4C04</b>
63 A	3 P	I - II	4321 <b>3C06</b>
	4 P	I - II	4321 <b>4C06</b>
	3 P	I - 0 - II	4331 <b>3C06</b>
	4 P	I - 0 - II	4331 <b>4C06</b>
100 A*	3 P	I - II	4321 <b>3C10</b>
	4 P	I - II	4321 <b>4C10</b>
	3 P	I - 0 - II	4331 <b>3C10</b>
	4 P	I - 0 - II	4331 <b>4C10</b>

\* For an ambient temperature of 35 °C

#### Dimensions (in/mm)

##### 25 to 40 A

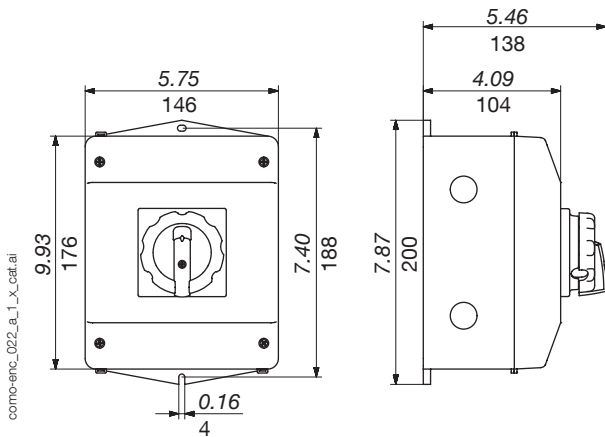

##### 63 to 100 A

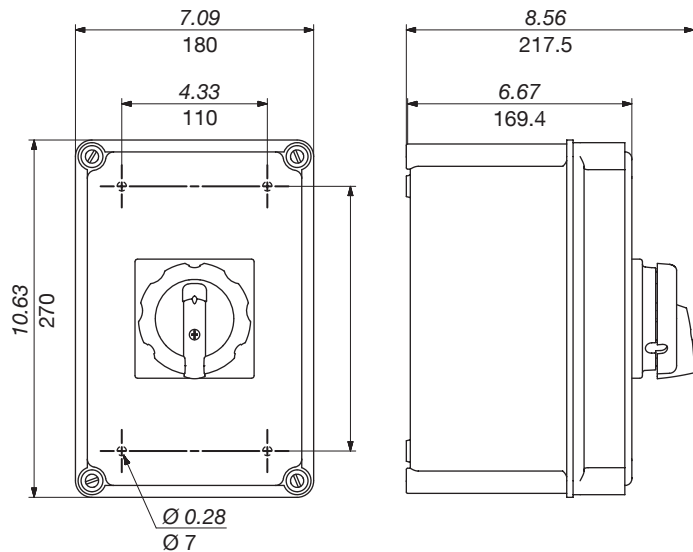

## Characteristics according to IEC 60947-3

### 25 to 100 A

<b>Conventional free air thermal current <math>I_{th}</math> at 40 °C (A)</b>	<b>25 A</b>	<b>40 A</b>	<b>63 A</b>	<b>100 A</b>
Conventional free air thermal current $I_{th}$ at 50 °C (A)	25	34	63	100
Conventional free air thermal current $I_{th}$ (60 °C) (A)	19	24	53	90
Rated insulation voltage $U_i$ (V)	690	690	690	690
Rated impulse withstand voltage $U_{imp}$ (kV)	4	6	6	6
<b>Rated operational currents <math>I_e</math> (A)</b>				
<b>Utilisation category at 400 VAC</b>				
AC-21A	25	40	63	100
AC-22A	20.5	40	63	100
AC-23A	15	29	63	63
AC-3	12	22	/	/
<b>Utilisation category at 690 VAC</b>				
AC-21A	25	40	63	100
AC-22A	20.5	40	63	100
AC-23A	8.5	17	63	63
AC-3	7	12.8	/	/
<b>Operational power in AC-23 (kW)<sup>(1)</sup></b>				
At 400 VAC without pre-break AC	7.5	15	37	37
At 690 VAC without pre-break AC	4.8	15	/	/
<b>Fuse protected short-circuit withstand with gG DIN fuses</b>				
Prospective short-circuit (kA rms)	7	10	5	5
Associated fuse rating (A)	25	40	63	100
Rated operational voltage (Va.c)	690	690	690	690
<b>Connection</b>				
Minimum CU cable cross-section (mm <sup>2</sup> )	0.5	1	1.5	4
Maximum CU cable cross-section (mm <sup>2</sup> )	4	10	16	35
Tightening torque min - max (Nm)	0.8-1.2	1.2-1.5	2.5	1.5
<b>Mechanical characteristics</b>				
Durability (number of operating cycles)	100 000	100 000	100 000	100 000
Weight of a 3 pole device (g)	109	184	440	440
Weight of a 4 pole device (g)	130	221	535	535

(1) The power is given for information only, the current values vary from one manufacturer to another.

## Characteristics according to UL 60947-4-1

### 25 to 100 A

<b>General use rating (A)</b>	<b>25 A</b>	<b>40 A</b>	<b>63 A</b>	<b>100 A</b>
UL certification file	88EJ		5LM6	
Short circuit rating at 600 VAC (kA)	10	5	/	
Type of fuse	RK5		/	
Max fuse rating (A)	150		/	
<b>Max horsepower rating (HP)</b>				
120 VAC / 1 phase	-	2	/	
120 VAC / 3 phase	-	5	/	
240 VAC / 1 phase	-	3	/	
240 VAC / 3 phase	-	10	/	
480 VAC / 3 phase	-	20	/	
600 VAC / 3 phase	5.2	20	/	
<b>Connection terminals</b>				
Solid wire (AWG)	#14-#12	#14-#8	#14-#4	#10-#2
Wire stripping distance (in/mm)	0.31 / 8	0.39 / 10	0.51 / 13	0.51 / 13
<b>Mechanical characteristics</b>				
Durability (number of operating cycles)	100000	100000	100000	100000
Tightening torque (Lb.in / N.m)	8.8 / 1	13.3 / 1.5	22.1 / 2.5	13.3 / 1.5
Weight of a 3 pole device (lb)	0.24	0.4	1	1
Weight of a 4 pole device (lb)	0.28	0.49	1.18	1.18

### Dimensions (in/mm)

#### 25 to 100A

##### Mounting on door - Fixing with direct handle

Door width		
Unit	Mini	Maxi
in	0.04	0.16
mm	1	4

Rating (A)	Unit	I-II / I-0-II		L		Bypass I-0-II		C	D
		3 P	4 P	3 P	4 P				
25	in	3.19	3.66	4.13	4.61	1.54	1.57	1.54	1.57
	mm	81	93	105	117	39	40		
40	in	3.31	4.82	4.33	4.84	2.11	2.2	2.11	2.2
	mm	84	97	110	123	53.6	56		
63 - 100	in	4.45	5.28	6.1	6.93	2.91	2.8	2.91	2.8
	mm	113	134	155	176	74	71		

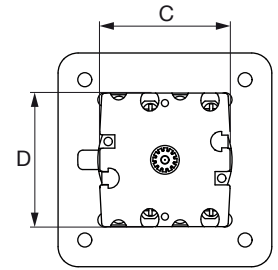
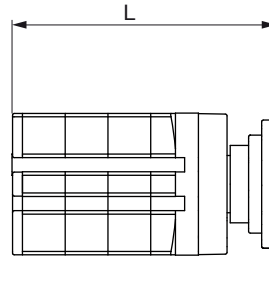

como\_261\_a\_1\_x\_cat.ai

##### Mounting on backplate / DIN rail - Rear fixing of direct handle

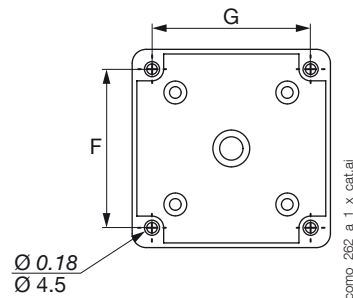
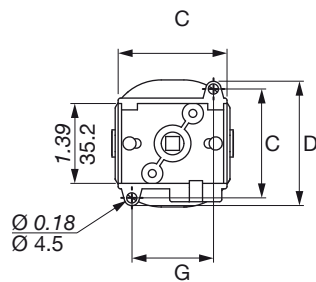
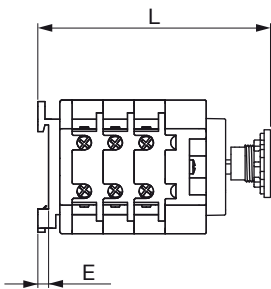

como\_262\_a\_1\_x\_cat.ai

Rating (A)	Unit	I-II / I-0-II		L		E	C	D	F	G
		3 P	4 P	3 P	4 P					
25	in	3.20	3.68	4.15	4.57	0.18	1.89	2.2	1.65	1.42
	mm	81.4	93.4	105.4	116.1	4.5	48	56	47	36
40	in	3.73	4.28	4.28	5.08	0.18	1.89	2.2	1.65	1.42
	mm	94.7	107.7	120.7	129	4.5	48	56	47	36
63 ... 100	in	5.10	5.97	6.83	7.54	-	2.99	2.99	2.68	2.68
	mm	129.5	151.5	173.5	191.5	-	76	76	68	68

##### Mounting on backplate / DIN rail - Rear fixing of external handle

Rating (A)	Unit	X-L <sup>(3)</sup>		E	B		
		I-II / I-0-II	Bypass I-0-II				
25	in	3.15	3.63	4.10	4.57	0.18	1.24
	mm	80.1	92.1	104.1	116.1	4.5	31.6
40	in	3.54	4.06	4.57	5.08	0.18	1.24
	mm	90	103	116	129	4.5	31.6
63 ... 100	in	5.06	5.89	6.71	7.54	-	1.24
	mm	128.5	149.5	170.5	191.5	-	31.6

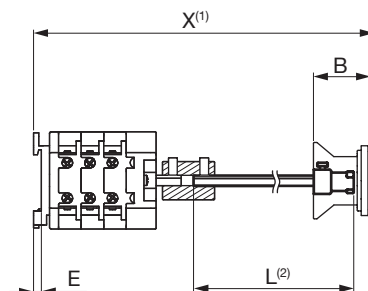

como\_263\_a\_1\_x\_cat.ai

(1) X is the distance between the inside of the door and the fixing plate  
 (2) L is the total length of the shaft (max 200 mm)  
 (3) Minimum distance between the inside of the door and the fixing plate

## Dimensions for handles

25 to 100 A

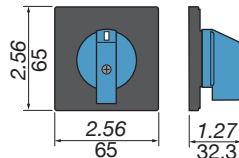
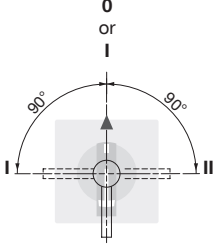
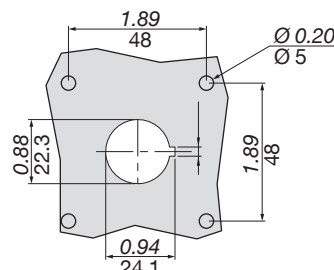
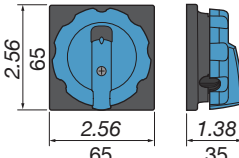
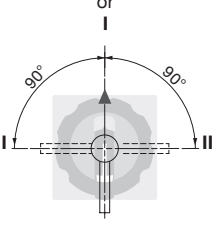
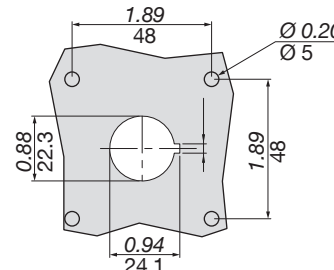
Handle type	Front operation Direction of operation	Door drilling
<p><b>K1 type</b> non padlockable</p> 	<p><b>Front operation</b> Direction of operation</p> 	<p><b>Door drilling</b></p>  <p style="text-align: right; font-size: small;">poign_075_a_1_gb_cat.ai</p>
<p><b>K1 type</b> padlockable</p> 	<p><b>Front operation</b> Direction of operation</p> 	<p><b>Door drilling</b></p>  <p style="text-align: right; font-size: small;">poign_076_a_1_gb_cat.ai</p>