



Harmony Solid State Relays

Slim interfaces, Modular DIN rail and
Panel mount solid state relays



Harmony

Discover [Harmony](#)

Advanced operator interface and industrial relays

Harmony operator interface and industrial relays enhance operational efficiency and equipment availability across industrial and building applications. **Harmony** includes intelligent connected products and edge terminals that visualize, gather and process data, enabling informed operator decisions

Explore our offer

- [Harmony Push Buttons and Switches](#)
- [Harmony HMI Operator Terminals, IPC and EdgeBox](#)
- [Harmony Signaling Devices](#)
- [Harmony Electrical Relays](#)
- [Harmony Safety](#)

Life Is On

Schneider
Electric

Quick access to product information

Get technical information about your product

References

Modicon TM3
I/O expansion modules for Modicon controllers
Analog I/O modules

Number and type of channels	Input range	Output range	Resolution	Input format (mA)	Reference	Weight (kg)
2 voltage inputs	-15...+15 VDC 0...20 mA r.t. 20 mA	16.00V or 12.00V r.t.	16.00V or 12.00V r.t.	0VDC 0VDC	TM3AI2H TM3AI2HG	0.110 0.100
4 voltage inputs	-15...+15 VDC 0...20 mA r.t. 20 mA	16.00V or 12.00V r.t.	16.00V or 12.00V r.t.	0VDC 0VDC	TM3AI4 TM3AI4G	0.110 0.100
4 voltage or temperature inputs	-15...+15 VDC 0...20 mA r.t. 20 mA	16.00V or 12.00V r.t.	16.00V or 12.00V r.t.	0VDC 0VDC	TM3AI4T TM3AI4TG	0.110 0.100
4 differential temperature inputs	-15...+15 VDC 0...20 mA r.t. 20 mA	16.00V or 12.00V r.t.	16.00V or 12.00V r.t.	0VDC 0VDC	TM3AI4D TM3AI4DG	0.110 0.100
8 self-diagnosis	-15...+15 VDC	16.00V or 12.00V r.t.	16.00V or 12.00V r.t.	0VDC 0VDC	TM3AI8 TM3AI8G	0.110 0.100

Share Price Global (English) My Products My Documents Partner Portal

Life Is On Schneider Electric Search products, documents & more

PRODUCTS SOLUTIONS SERVICES SUPPORT ABOUT US

All products Industrial Automation and Control PLC, PAC and Dedicated Controllers Distributed Input/Output (I/O) Modules Modicon TM3

View all Modicon TM3

TM3AI2H

Module TM3 - 2 analog inputs high resolution

Show more characteristics >

Related Software >

Product Datasheet User guide Catalogue CAD Document

Characteristics Documents and Downloads Technical FAQs Additional Information Dimensions Drawings >

Main

range of product Modicon TM3

product or component type Analog input module

range compatibility Modicon M251

Each commercial reference presented in a catalog contains a hyperlink. Click on it to obtain the technical information of the product:

- Characteristics, Dimensions and drawings, Mounting and clearance, Connections and schemas, Performance curves
- Product image, Instruction sheet, User guide, Product certifications, End of life manual

Find your catalog

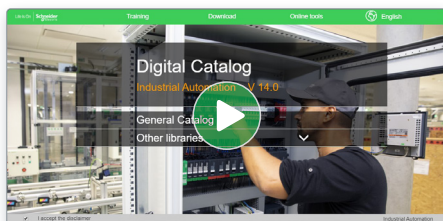

- > With just 3 clicks, you can access the Industrial Automation and Control catalogs, in both English and French
- > Consult digital automation catalogs at [Digi-Cat Online](#)

Industrial Automation

General Catalog

- Publications, Selections, PLCs, CPUs & I/O
- Books, Catalogs & Interfaces
- Signaling Devices
- HMI (Terminals and Industrial PC)
- Sensors & RFID System
- Motor Starters and Load Management
- Components for Motor Starters
- Variable Speed Drives & Soft Starters
- Motor Control & Robotics
- Interface, Measurement & Control Relays
- PLC, PAC & other Controllers

Publications, Selections, PLCs, CPUs & I/O

Hardware 380

Product Selector

360°

- Up-to-date catalogs
- Embedded product selectors, 360° pictures
- Optimized search by commercial references

Select your training



- > Find the right [Training](#) for your needs on our Global website
- > Locate the training center with the selector tool, using this [link](#)

Training and courses

Training by domain of expertise

- Electrical Installation and Safety
- Data Center
- Industrial Automation

General contents

Harmony Solid State Relays

■ General presentation

- Choose slim interfacing solution with SSL relays [page 2](#)
- Choose reliability and flexibility with the innovative
DIN rail mount SSD relays [page 3](#)
- Choose modularity with DIN rail mount SSM relays [page 4](#)
- Choose complete panel mount solution with SSP relays [page 5](#)

[Selection guide](#) [page 6](#)

■ SSL solid state slim relays

- Presentation of the range [page 8](#)
- Relay and socket description [page 8](#)
- References [page 9](#)
 - Pre-assembled solid state slim relays [page 9](#)
 - Relays and sockets for customer assembly [page 10](#)
 - Accessories [page 11](#)

■ SSD solid state DIN rail relays

- Presentation of the range [page 12](#)
- Relay description [page 12](#)
- References [page 13](#)
 - SSD1 single-phase solid state relays (22.5 and 45 mm) [page 13](#)
 - Accessories [page 13](#)

■ SSM solid state modular DIN rail relays

- Presentation of the range [page 14](#)
- Relay description [page 14](#)
- References [page 16](#)
 - SSM1 single-phase solid state relays (12 and 18 mm) [page 16](#)
 - SSM1 single-phase solid state relays (22.5 and 45 mm) [page 17](#)
 - SSM2 single-phase solid state relays, dual channel [page 17](#)
 - SSM3 three-phase solid state relays [page 17](#)
 - Accessories [page 17](#)

■ SSP solid state panel mount relays

- Presentation of the range [page 18](#)
- Relay description [page 18](#)
- References [page 19](#)
 - SSP1 single-phase solid state relays [page 19](#)
 - SSP3 three-phase solid state relays [page 20](#)
 - Heat sinks and accessories [page 21](#)

■ [Product reference index](#) [page 22](#)

Harmony Relays - Solid State Relays

Choose long life and silent operation with Harmony SSRs

Maintenance free

fully electronic,
unlimited life span

High switching frequency

allows precise and quick control

Silent and reliable switching

no moving parts,
noiseless switching

Sustainability in harsh environment

resistance to shock,
vibration, and
contamination

The Harmony SSR series offers slim interface (SSL), modular DIN rail (SSD, SSM) and panel mount (SSP) solid state relays that provide complete, compact, and innovative solutions for a wide variety of applications with interfacing control and load switching. They are the ideal solution for packaging, plastic molding, textile, and heating furnace applications.

Choose a slim interfacing solution with SSL relays

Slim relay-socket solution

- > Complete range of control input and load output configurations for both AC and DC switching applications
- > Compact solution with 6 mm/0.236 in. width, allows customers to choose the combination of relays and associated sockets from the wide range available

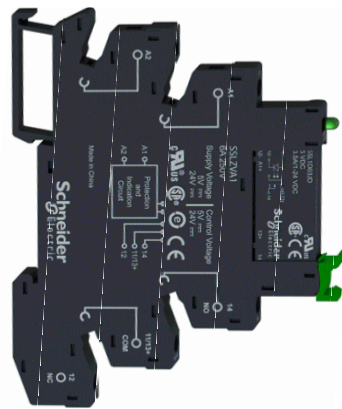

Pre-assembled SSL relays*

Control input voltage	Load output voltage
~ 4...12 V	~ 1...24 V ~ 1...48 V ~ 24...250 V
~ 16...30 V	~ 1...24 V ~ 1...48 V ~ 24...250 V

* SSL relays + SSLZ sockets

SSL slim interface relay mounted on SSLZ socket

Enhanced performance in any situation

- > Socket with integrated reverse polarity protection circuit and control input/relay status LED indicator
- > IP 67 protection and fully encapsulated



LED indicator for relay status

Simplified installation and mounting

- > Locking/unlocking lever for replacing relay from the socket
- > Simple mounting on DIN rail
- > Choice of screw connector and spring terminal connection for sockets



Screw connector



Spring terminal

SSL (1-phase) + SSLZ (socket) → Slim plug-in interface solution

Choose reliability and flexibility with innovative DIN rail mount SSD relays

Performance

- > High I²T (up to 8320 A²S) to facilitate the use of circuit breakers instead of fuses, allowing Type 1 coordination protection (as per IEC 60947-4-3)
- > High current rating (up to 35 A for 22.5 mm models, and up to 60 A for 45 mm models) at a compact size, optimizing the size of your enclosure
- > Surge protection from applications with built-in transient overvoltage protection

Flexibility

- > Relay and Contactor configuration to suit your wiring preferences
- > Telescopic screw terminal options available to facilitate the use of lug terminals

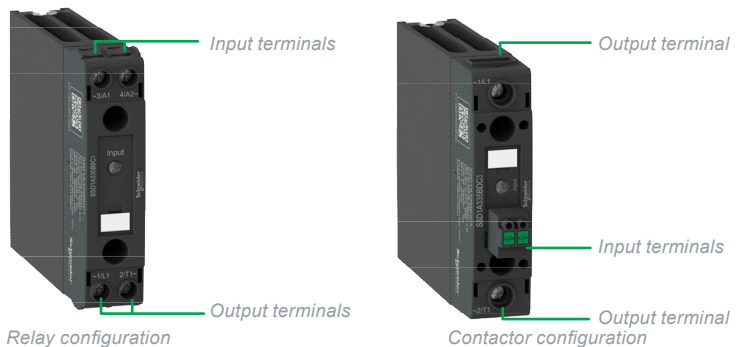

Simplified selection and installation

- > Integrated heat sink to eliminate the need for thermal calculation
- > Spring and screw input connectors option is available for simplified wiring

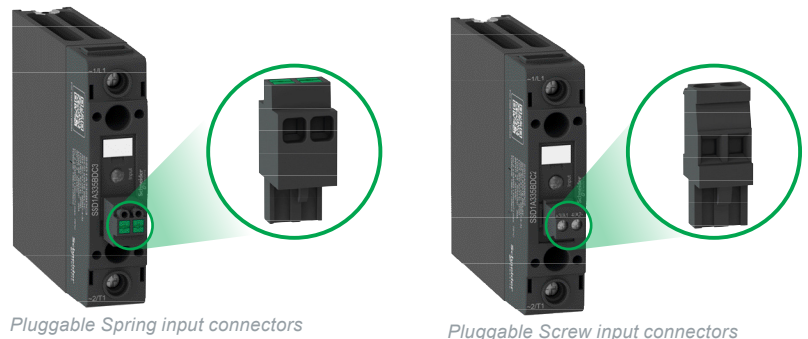

Wide range of standards and certifications

- > Complies with IEC 61373 for railway and rolling stock application
- > Electromagnetic compatibility complying to IEC 60947-4-3 standard
- > Conforms to a wide range of internationally recognized standards and certification

22.5mm/0.886 in.



SSD1: 20, 30 and 35 A single-phase SSR

45mm/1.772 in.



SSD1: 45 and 60 A single-phase SSR

SSD relays	
Control input voltage	Load output voltage
⎓ 4...32 V	⎓ 1...150 V ~ 48...600 V
~ 90...280 V	~ 48...600 V

Note: The SSD1 range references will be substituting the SSM1 range references for 22.5 mm/0.886 in. width (20 A, 30 A) and 45 mm/1.771 in. width (45 A, 55 A).

Harmony SSR → The new generation solid state relays

Choose modularity with DIN rail mount SSM relays

Ready to use “Plug and play”

- > Modular design of IP 20 housing and built-in heat sink for optimized operating conditions
- > Easy mounting on standard 35 mm/1.378 in. DIN rail with a secure mounting latch

Compact design

- > Requires less panel space due to slim width and thus reduces the size of your enclosures
- > Optimized modular design available in various sizes (11, 18, 22.5, 45 and 90 mm width) with load output current of 6, 12, 20, 30, 45, and 55 A

11 mm/0.433 in.



SSM1: 6 A single-phase SSR

18 mm/0.709 in.



SSM2: 6 A dual channel, single-phase SSR

SSM1 relays	
Control input voltage	Load output voltage
---4...32V	---1...48V ---1...100V
---4...32V	~24...280V ~48...600V
~18...36V ~90...140V ~200...265V	~24...280V ~48...600V

SSM2 relays	
Control input voltage	Load output voltage
---4...32V	~24...280V ~48...600V

22.5 mm/0.886 in.



SSM1: 20 and 30 A single-phase SSR

45 mm/1.772 in.



SSM1: 45 and 55 A single-phase SSR

SSM1 relays	
Control input voltage	Load output voltage
---4...32V	~24...280V ~48...660V
---3...32V	~24...280V
~90...140V ~90...280V	~24...280V ~48...660V

90 mm/3.543 in.



SSM3: 25 A three-phase SSR

SSM3 relays	
Control input voltage	Load output voltage
---4...32V	~48...600V
~90...140V	~48...600V
~180...280V	~48...600V

Enhanced modular solution

- > Wide choice of relays with single-phase and three-phase options and current ratings from 6 A to 55 A
- > Zero voltage switching for resistive loads and random switching for inductive loads
- > UL and cUL approved including the general purpose and motor controller rating standards

SSM1 (1-phase)/SSM2 (1-phase dual channel)/SSM3 (3-phase) → Plug & Play solution

Choose a complete panel mount solution with SSP relays

Complete solution

- > Single-phase and three-phase panel mount solid state relays with a range of heat sinks and accessories to meet application needs from 10 A to 125 A
- > Easy product selection with simplified product nomenclature and direct heat sink selection available in product data sheets
- > Wide choice of heat sinks with thermal resistance ratings of 0.2 °C/W to 2.5 °C/W



SSP1: Single-phase panel mount SSR

SSP1.relays	
Control input voltage	Load output voltage
⋯ 3.5...32 V	⋯ 1...150 V
⋯ 3...32 V	~ 24...300 V
⋯ 4...32 V	~ 48...660 V
~ 90...280 V	~ 24...300 V
	~ 48...660 V



SSP1.S: Single-phase panel mount SSR with smart diagnostic features

SSP1.S.relays	
Control input voltage	Load output voltage
⋯ 3...32 V	~ 24...300 V
⋯ 4...32 V	~ 48...660 V

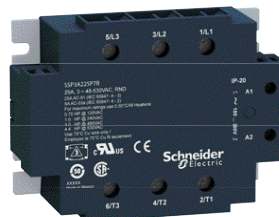

SSP3: Three-phase panel mount SSR

SSP3.relays	
Control input voltage	Load output voltage
⋯ 4-32 V	~ 48-530 V
~ 18-36 V	~ 48-530 V
~ 90-140 V	
~ 180-280 V	

Simple, safe, and robust screw terminals

- > Simple and easy wiring; accepts wires with different kinds of terminations (cable ends, fork lug, ring lug)
- > Safe and fool-proof design with IP 20 protection and integrated enclosure
- > Robust self-aligned screw terminals with proven effectiveness in helping to prevent screw jams

Innovative SSP1.S with smart diagnostics and test button

- > Smart diagnostic features with built-in visual indicator and alarm output enables quick response to unexpected results and correct monitoring of SSR operation
- > A test button for easy debugging, testing, and commissioning

Simplified installation and mounting

- > Product option with readily available factory-fit thermal pad
- > Heat sink offers panel and DIN rail mounting options

SSP1 (1-phase)/SSP3 (3-phase) + SSRH (Heat sinks) → Complete solution

Type of product	Slim interface SSR		Modular DIN rail SSR	
	Customer assembly (Relay and socket)	Pre-assembled (Relay with socket)		
Number of phases	1	1	1	1
Type of mounting	Plug-in PCB pins with DIN rail mounted socket		DIN rail mounted	DIN rail mounted
Control input voltage	~	–	90...280 V	18...36 V 90...140 V 200...265 V
	---	3...12 V 15...30 V 16...30 V	4...12 V 16...30 V	4...32 V 90...280 V
Output load voltage	~	24...280 V	24...250 V	48...600 V
	---	1...24 V 1...48 V	1...24 V 1...48 V	1...150 V
Output load current	~	2 A	20,35 A for 22.5 mm/0.886 in. 40, 60 A for 45 mm/1.772 in.	6 A for 12 mm/0.472 in. 12 A for 18 mm/0.709 in.
	---	0.1, 3.5 A	20,30 A for 22.5 mm/0.886 in.	6 A for 12 mm/0.472 in. 12 A for 18 mm/0.709 in.
Type of switching	Zero voltage	Yes	Yes	Yes
	Random	Yes	Yes	Yes
	DC	Yes	Yes	Yes
Cooling	–	–	Built-in heat sink	Built-in heat sink
Degree of protection	–	IP 67 (encapsulation) IP 20 (socket)	IP 20	IP 20
LED indication	–	Yes (on socket)	Yes	Yes
Solid state relay type	SSL (1) (2)		SSD1 (3)	SSM1
Pages	9		13	16 and 17

(1) SSL slim relays and SSLZ sockets.

(2) Pre-assembled SSL slim relays (relay + socket).

(3) The SSD1 range references will be substituting the SSM1 range references for 22.5 mm/0.886 in. width (20 A, 30 A) and 45 mm/1.771 in. width (45 A, 55 A).

Modular DIN rail SSR (continued)			Panel mount SSR	
1	1 (dual SSR)	3	1	3
DIN rail mounted	DIN rail mounted	DIN rail mounted	Panel mounted	Panel mounted
90...140 V 90...280 V	–	90...140 V 90...280 V	90...280 V	18...36 V 90...140 V 180...280 V
3...32 V 4...32 V	4...32 V	4...32 V	3...32 V 4...32 V	4...32 V
24...280 V 48...660 V	24...280 V 48...600 V	48...600 V	24...300 V 48...660 V	48...530 V
–	–	–	1...150 V	–
20, 30 A for 22.5 mm/0.886 in. 45, 55 A for 45 mm/1.772 in.	6 A	25 A	10, 25, 50, 75, 90, 125 A	25, 50 A
–	–	–	12, 25, 40 A	–
Yes	Yes	Yes	Yes	Yes
–	Yes	Yes	–	Yes
–	–	–	Yes	–
Built-in heat sink	Built-in heat sink	Built-in heat sink	Option with thermal pad	Option with thermal pad
IP 20	IP 20	IP 20	IP 20	IP 20
Yes	Yes	Yes	Yes	Yes
SSM1 (3)	SSM2	SSM3	SSP1	SSP3
16 and 17	17	17	19	20

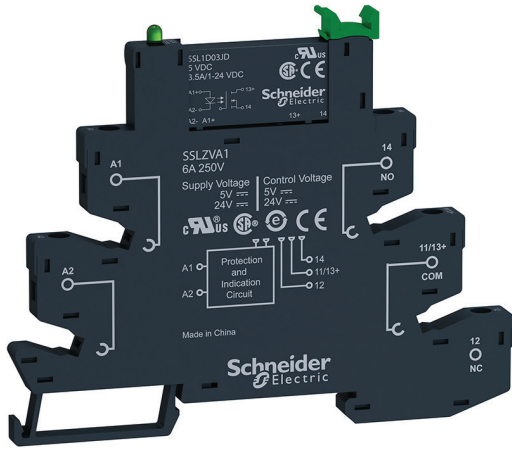

Pre-assembled solid state relay

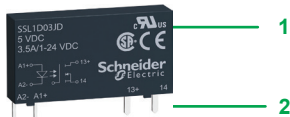

SSL relay

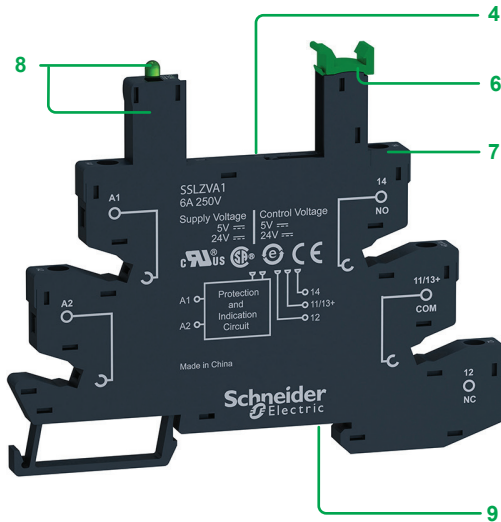

Socket equipped with LED and protection circuit

Presentation of the range

SSL solid state relays offer the advantages of several input and output configurations for both AC and DC switching applications. Their compact size and modular design reduces space and allows easy mounting on the socket.

The plug-in type relays can be mounted directly on a PCB or with a socket on a standard 35 mm/1.378 in. DIN rail. The sockets are available in screw connector and spring terminal types.

SSL relays offer:

- A choice of relays and sockets to suit a range of operating voltages
- Zero voltage switching for resistive load and random switching for inductive load applications
- Simple maintenance as the relays can be held in place/released by locking/unlocking the lever without disconnecting the socket wiring
- Socket with reverse polarity protection circuit and LED indicator for easy identification of control status

These relays are available in both pre-assembled (single reference) and customer assembled offers.

Relay description

SSL slim solid state relays

- 1 Relay with 1 N/O contact and any one of the following ratings:
 - 24 V $\overline{\text{---}}$, 3.5 A
 - 48 V $\overline{\text{---}}$, 100 mA
 - 280 V \sim , 2 A
- 2 4 flat, reinforced pins (PCB type)
- 3 5 mm/0.197 in. relay width for up to 3.5 A of load current

Socket description

Sockets for SSL slim solid state relays

- 4 5 female contacts for the relay pins
- 5 6.2 mm/0.244 in. socket width
- 6 Lever for locking or releasing the relay from its socket with clip-in marker legend
- 7 Wire connection by screw connectors or spring terminals
- 8 Built-in reverse polarity protection circuit and LED indicator
- 9 Locating slot for mounting on DIN rail



SSL1A12JDRPR

Pre-assembled solid state slim relays					
Relays mounted on screw sockets (sold in lots of 30)					
Switching	Voltage range		Load current range	Reference	Weight
	Control input	Load output			
	V	V	A	kg/lb	
DC Switching	≡ 4 to 12	≡ 1 to 24	3.5	SSL1D03JDPV (SSL1D03JD + SSLZVA1)	0.033/0.073
	≡ 4 to 12	≡ 1 to 48	0.1	SSL1D101JDPV (SSL1D101JD+SSLZVA1)	0.033/0.073
Zero voltage switching	≡ 4 to 12	~ 24 to 250	2	SSL1A12JDPV (SSL1A12JD+SSLZVA1)	0.033/0.073
Random switching	≡ 4 to 12	~ 24 to 250	2	SSL1A12JDRPV (SSL1A12JDR+SSLZVA1)	0.033/0.073
DC Switching	≡ 16 to 30	≡ 1 to 24	3.5	SSL1D03BDPV (SSL1D03BD+SSLZVA1)	0.033/0.073
	≡ 16 to 30	≡ 1 to 48	0.1	SSL1D101BDPV (SSL1D101BD+SSLZVA1)	0.033/0.073
Zero voltage switching	≡ 16 to 30	~ 24 to 250	2	SSL1A12BDPV (SSL1A12BD+SSLZVA1)	0.033/0.073
Random switching	≡ 16 to 30	~ 24 to 250	2	SSL1A12BDRPV (SSL1A12BDR+SSLZVA1)	0.033/0.073
Relays mounted on spring sockets (sold in lots of 30)					
DC Switching	≡ 4 to 12	≡ 1 to 24	3.5	SSL1D03JDPR (SSL1D03JD+SSLZRA1)	0.033/0.073
	≡ 4 to 12	≡ 1 to 48	0.1	SSL1D101JDPR (SSL1D101JD+SSLZRA1)	0.033/0.073
Zero voltage switching	≡ 4 to 12	~ 24 to 250	2	SSL1A12JDPR (SSL1A12JD+SSLZRA1)	0.033/0.073
Random switching	≡ 4 to 12	~ 24 to 250	2	SSL1A12JDRPR (SSL1A12JDR+SSLZRA1)	0.033/0.073
DC Switching	≡ 16 to 30	≡ 1 to 24	3.5	SSL1D03BDPR (SSL1D03BD+SSLZRA1)	0.033/0.073
	≡ 16 to 30	≡ 1 to 48	0.1	SSL1D101BDPR (SSL1D101BD+SSLZRA1)	0.033/0.073
Zero voltage switching	≡ 16 to 30	~ 24 to 250	2	SSL1A12BDPR (SSL1A12BD+SSLZRA1)	0.033/0.073
Random switching	≡ 16 to 30	~ 24 to 250	2	SSL1A12BDRPR (SSL1A12BDR+SSLZRA1)	0.033/0.073

PF123409A



SSL1A12JD

PF123420B



SSLZVA1 + SSL1D03JD

Relays and sockets for customer assembly

SSL single-phase solid state relays (sold in lots of 12)

Switching	Voltage range		Load current range	Reference	Weight
	Control input	Load output			
	V	V	A		kg/lb
DC switching	~ 3 to 12	~ 1 to 24	3.5	SSL1D03JD	0.004/0.009
		~ 1 to 48	0.1	SSL1D101JD	0.004/0.009
	~ 15 to 30	~ 1 to 24	3.5	SSL1D03BD	0.004/0.009
		~ 1 to 48	0.1	SSL1D101BD	0.004/0.009
Zero voltage switching	~ 3 to 12	~ 24 to 280	2	SSL1A12JD	0.004/0.009
	~ 15 to 30	~ 24 to 280	2	SSL1A12BD	0.004/0.009
Random switching	~ 3 to 12	~ 24 to 280	2	SSL1A12JDR	0.004/0.009
	~ 15 to 30	~ 24 to 280	2	SSL1A12BDR	0.004/0.009

Sockets equipped with LED and protection circuit (sold in lots of 10)

Control voltage (Nominal)	For use with relays	Socket type		Unit reference	Weight
		Screw connector	Spring terminals		
V		Unit reference	Weight	Unit reference	Weight
			kg/lb		kg/lb
~ 5	SSL1D03JD SSL1D101JD SSL1A12JD SSL1A12JDR	SSLZVA1	0.029/0.063	SSLZRA1	0.029/0.063
~ 24	SSL1D03BD SSL1D101BD SSL1A12BD SSL1A12BDR	SSLZVA1	0.029/0.063	SSLZRA1	0.029/0.063



RSLZ2



RSLZ3

Accessories for sockets

Description	Compatibility	Reference	Weight kg/lb
Clip-in legends (2 sheets of 64 legends)	SSL sockets	RSLZ5	0.001/0.002
Bus jumper (10 x 20-pole jumper)	SSL sockets	RSLZ2	0.003/0.007
Partition plate (10 partition plates)	SSL sockets	RSLZ3	0.001/0.002

Presentation of the range

SSD1 solid state relays are single-phase DIN rail mounted relays with high-power density of up to 60 A and built-in heat sink. They are available in two configurations, namely the relay and contactor types.

The **SSD1** family offers a unique range of terminal connections (input connectors: spring or screw plug-in, output terminals: telescopic, clamp cage or standard screw) providing options as per the wiring preference.

Relay description

SSD1 relay, 22.5 mm/0.886 in. – Relay configuration

- 1 Locating slot for mounting on DIN rail
- 2 Built-in heat sink for heat dissipation
- 3 Control input connection terminals
- 4 Fixing hole for attaching relay to heat sink
- 5 LED input status indicator
- 6 Clip-in legend for easy identification
- 7 Load output connection terminals

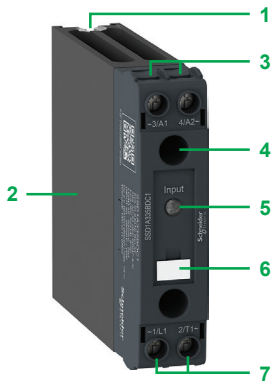

SSD1 single-phase solid state DIN rail relay, 22.5 mm

SSD1 relay, 22.5 mm/0.886 in. – Contactor configuration with pluggable (screw or spring) input connector

- 1 Locating slot for mounting on DIN rail
- 2 Built-in heat sink for heat dissipation
- 3 Load output connection terminals
- 4 Fixing hole for attaching relay to heat sink
- 5 LED input status indicator
- 6 Clip-in legend for easy identification
- 7 Pluggable input connector (spring or screw options available)

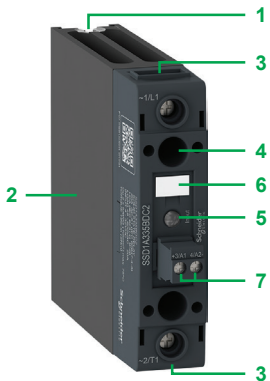

SSD1 single-phase solid state DIN rail contactor with pluggable screw input, 22.5 mm

SSD1 relay, 45 mm/1.771 in. – Contactor configuration with pluggable (screw or spring) input connector

- 1 Locating slot for mounting on DIN rail
- 2 Built-in heat sink for heat dissipation
- 3 Load output connection terminals
- 4 Fixing hole for attaching relay to heat sink
- 5 LED input status indicator
- 6 Clip-in legend for easy identification
- 7 Pluggable input connector (spring or screw options available)
- 8 Lugs for panel mounting

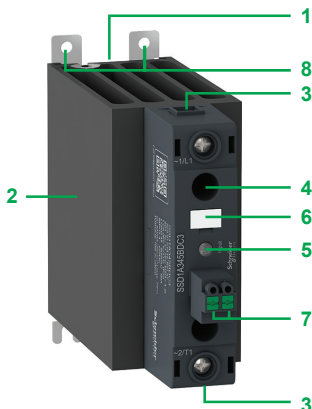

SSD1 single-phase solid state DIN rail contactor with pluggable spring input, 45 mm



SSD1 single-phase solid state relays (22.5 and 45 mm) (1)							
Switching	Voltage range		Load current range	Configuration	Reference	Weight	
	Control input	Load output					
	V	V	A			kg/lb	
DC switching	--- 4...32	--- 1...150	20	Relay	SSD1D520BDC1	0.298/0.657	
			30	Relay	SSD1D530BDC1	0.298/0.657	
Zero voltage switching	--- 4...32	~ 48...600	20	Relay	SSD1A320BDC1	0.298/0.657	
			20	Contactor, Screw input connector	SSD1A320BDC2	0.301/0.664	
			20	Contactor, Spring input connector	SSD1A320BDC3	0.301/0.664	
			35	Relay	SSD1A335BDC1	0.298/0.657	
			35	Contactor, Screw input connector	SSD1A335BDC2	0.301/0.664	
			35	Contactor, Spring input connector	SSD1A335BDC3	0.301/0.664	
			45	Contactor, Screw input connector	SSD1A345BDC2	0.507/1.117	
			45	Contactor, Spring input connector	SSD1A345BDC3	0.507/1.117	
		~ 90...280	~ 48...600	20	Relay	SSD1A320M7C1	0.298/0.657
				20	Contactor, Screw input connector	SSD1A320M7C2	0.301/0.664
				20	Contactor, Spring input connector	SSD1A320M7C3	0.301/0.664
				35	Relay	SSD1A335M7C1	0.298/0.657
				35	Contactor, Screw input connector	SSD1A335M7C2	0.301/0.664
				35	Contactor, Spring input connector	SSD1A335M7C3	0.301/0.664
				45	Contactor, Screw input connector	SSD1A345M7C2	0.507/1.117
				45	Contactor, Spring input connector	SSD1A345M7C3	0.507/1.117
Random switching	--- 4...32	~ 48...600	20	Relay	SSD1A320BDC1	0.298/0.657	
			20	Contactor, Screw input connector	SSD1A320BDC2	0.301/0.664	
			20	Contactor, Spring input connector	SSD1A320BDC3	0.301/0.664	
			35	Relay	SSD1A335BDC1	0.298/0.657	
			35	Contactor, Screw input connector	SSD1A335BDC2	0.301/0.664	
			35	Contactor, Spring input connector	SSD1A335BDC3	0.301/0.664	
			45	Contactor, Screw input connector	SSD1A345BDC2	0.507/1.117	
			45	Contactor, Spring input connector	SSD1A345BDC3	0.507/1.117	
		~ 90...280	~ 48...600	20	Relay	SSD1A320M7C1	0.298/0.657
				20	Contactor, Screw input connector	SSD1A320M7C2	0.301/0.664
				20	Contactor, Spring input connector	SSD1A320M7C3	0.301/0.664
				35	Relay	SSD1A335M7C1	0.298/0.657
				35	Contactor, Screw input connector	SSD1A335M7C2	0.301/0.664
				35	Contactor, Spring input connector	SSD1A335M7C3	0.301/0.664
				45	Contactor, Screw input connector	SSD1A345M7C2	0.507/1.117
				45	Contactor, Spring input connector	SSD1A345M7C3	0.507/1.117

Accessories				
Description	For use with	Sold in lots of	Unit reference	Weight kg/lb
Clip-in Legends, Blank strip	All SSD1 solid state relays	10	SSDZLB	0.002/0.004
Clip-in Legends, Numbered strip (1 to 10)	All SSD1 solid state relays	10	SSDZLN1	0.002/0.004
Clip-in Legends, Numbered strip (11 to 20)	All SSD1 solid state relays	10	SSDZLN2	0.002/0.004

(1) The SSD1 range references will be substituting the SSM1 range references for 22.5 mm/0.886 in. width (20 A, 30 A) and 45 mm/1.771 in. width (45 A, 55 A).

Presentation of the range

SSM solid state relays are compact relays offering greater power density. The modular IP 20 housing design and built-in heat sink offer optimized operating solutions.

The SSM relay range comprises:

- **SSM1:** Single-phase SSR relays with 6, 12, 20, 30, 45, and 55 A ratings
- **SSM2:** Single-phase dual SSR relays with 6 A rating
- **SSM3:** Three-phase SSR relays with 25 A rating

Relay description

SSM1 relays, 12 mm/0.472 in. width and 18 mm/0.709 in. width

- 1 Built-in heat sink for heat dissipation
- 2 Control input connection terminals
- 3 Control input voltage LED indicator in green
- 4 Bracket for mounting on 35 mm/1.378 in. DIN rail
- 5 Load output connection terminals
- 6 Mounting latch

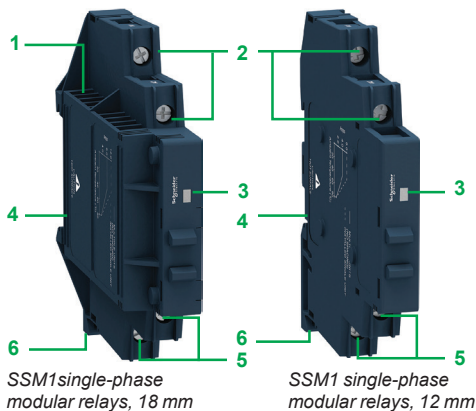

SSM1 relays, 22.5 mm/0.886 in. (20 A, 30 A) width and 45 mm/1.771 in. (45 A, 55 A) width

- 1 Lugs for panel mounting
- 2 Built-in heat sink for heat dissipation
- 3 Control input connection terminals
- 4 Control input voltage LED indicator in green
- 5 Bracket for mounting on 35 mm/1.378 in. DIN rail
- 6 Load output connection terminals



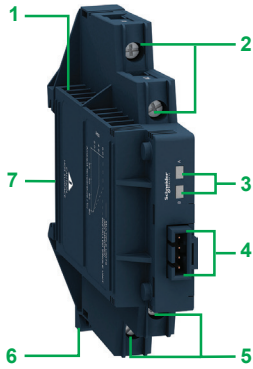

SSM2 single-phase dual channel modular relays, 18 mm

Relay description

SSM2 relays, 18 mm/0.709 in. width

- 1 Built-in heat sink for heat dissipation
- 2 Load output connection terminals for Channel A
- 3 Separate input voltage LED indicator in green
- 4 Separate control input connection terminals
- 5 Load output connection terminals for Channel B
- 6 Mounting latch
- 7 Bracket for mounting on 35 mm/1.378 in. DIN rail



SSM3 single-phase modular relays, 90 mm

SSM3 relays, 90 mm/0.354 in. width

- 1 Lugs for panel mounting
- 2 Built-in heat sink for heat dissipation
- 3 Control input connection terminals
- 4 Control input voltage LED indicator in green
- 5 Bracket for mounting on 35 mm/1.378 in. DIN rail
- 6 Load output connection terminals

Harmony Solid State Relays

SSM solid state modular DIN rail relays



SSM1A36BD



SSM1A312BD

SSM1 single-phase solid state relays (6 A, 12 mm and 12 A, 18 mm)							
Switching	Voltage range		Load current range	Reference	Weight		
	Control input	Load output					
	V	V	A		kg/lb		
DC switching	≡ 4...32	≡ 1...60	6	SSM1D26BD	0.050/0.110		
			12	SSM1D212BD	0.090/0.198		
	≡ 1...100	6	SSM1D36BD	0.050/0.110			
			12	SSM1D312BD	0.090/0.198		
		Zero voltage switching	≡ 4...32	~ 24...280	6	SSM1A16BD	0.050/0.110
					12	SSM1A112BD	0.090/0.198
~ 48...600	6		SSM1A36BD	0.050/0.110			
			12	SSM1A312BD	0.090/0.198		
	~ 18...36		~ 24...280	6	SSM1A16B7	0.050/0.110	
				12	SSM1A112B7	0.090/0.198	
~ 48...600	12	SSM1A312B7	0.090/0.198				
		~ 90...140	~ 24...280	6	SSM1A16F7	0.050/0.110	
12	SSM1A112F7			0.090/0.198			
~ 48...600	12		SSM1A312F7	0.090/0.198			
			~ 200...265	~ 24...280	6	SSM1A16P7	0.050/0.110
12	SSM1A112P7	0.090/0.198					
Random switching	≡ 4...32	~ 24...280	6	SSM1A16BDR	0.050/0.110		
			12	SSM1A112BDR	0.090/0.198		
	~ 48...600	6	SSM1A36BDR	0.050/0.110			
			12	SSM1A312BDR	0.090/0.198		
		~ 18...36	~ 24...280	6	SSM1A16B7R	0.050/0.110	
				12	SSM1A112B7R	0.090/0.198	
	~ 48...600	12	SSM1A312B7R	0.090/0.198			
			~ 90...140	~ 24...280	12	SSM1A112F7R	0.090/0.198
	~ 48...600	12			SSM1A312F7R	0.090/0.198	
			~ 200...265	~ 24...280	12	SSM1A112P7R	0.090/0.198
	12	SSM1A312P7R			0.090/0.198		

Harmony Solid State Relays

SSM solid state modular DIN rail relays



SSM1A120M7



SSM1A445BD



SSM2A36BDR



SSM3A325F7



SSRAC200

SSM1 single-phase solid state relays (22.5 and 45 mm) (1)

Switching	Voltage range		Load current range	Reference	Weight
	Control input	Load output			
	V	V	A		kg/lb
Zero voltage switching	= 4...32	~ 24...280	20	SSM1A120BD	0.280/0.617
			30	SSM1A130BD	0.280/0.617
	= 3...32	~ 24...280	45	SSM1A145BD	0.476/1.049
			= 4...32	~ 48...660	30
	45	SSM1A445BD			0.476/1.049
	= 4...32	~ 48...660	55	SSM1A455BD	0.476/1.049
			~ 90...280	~ 24...280	20
	30	SSM1A130M7			0.280/0.617
	~ 90...140	~ 48...660	30	SSM1A430M7	0.280/0.617
			45	SSM1A445F7	0.476/1.049
			55	SSM1A455F7	0.476/1.049

SSM2 single-phase solid state relays, dual channel (6 A, 18 mm)

Switching	Voltage range		Load current range	Reference	Weight
	Control input	Load output			
	V	V	A		kg/lb
Zero voltage switching	= 4...32	~ 24...280	6	SSM2A16BD	0.090/0.198
Random switching	= 4...32	~ 24...280	6	SSM2A16BDR	0.090/0.198
		~ 48...600	6	SSM2A36BDR	0.090/0.198

SSM3 three-phase solid state relays (25 A, 90 mm)

Switching	Voltage range		Load current range	Reference	Weight	
	Control input	Load output				
	V	V	A		kg/lb	
Zero voltage switching	= 4...32	~ 48...600	25	SSM3A325BD	0.740/1.631	
		~ 90...140	~ 48...600	25	SSM3A325F7	0.740/1.631
		~ 180...280	~ 48...600	25	SSM3A325P7	0.740/1.631
Random switching	= 4...32	~ 48...600	25	SSM3A325BDR	0.740/1.631	

Accessories

Description	Types of relay supported	Unit reference	Weight
4 Pin connector cable for SSM2 relay	SSM2A16BD, SSM2A16BDR, SSM2A36BDR	SSRAC200	0.055/0.121

(1) The SSD1 range references will be substituting the SSM1 range references for 22.5 mm/0.886 in. width (20 A, 30 A) and 45 mm/1.771 in. width (45 A, 55 A).

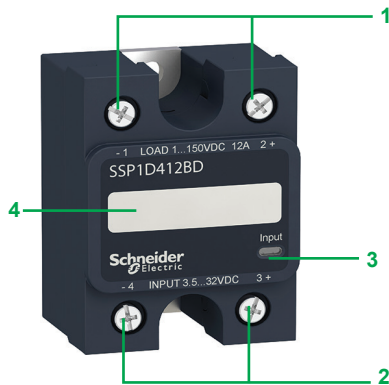

SSP1 single-phase panel mount relays

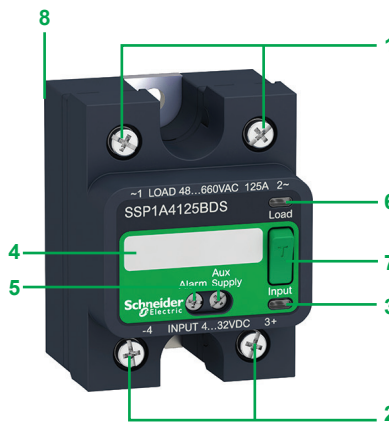

SSP1 single-phase panel mount relays with smart diagnostic feature

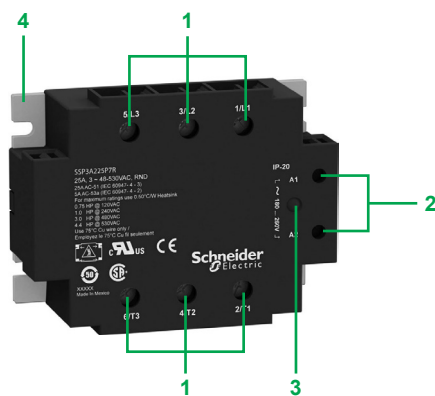

SSP3 three-phase panel mount relays

Presentation of the range

SSP solid state relays are single-phase and three-phase panel mount relays that offer complete solid state control and switching solutions.

- Easy product selection with simplified product nomenclature and direct heat sink selection available in product data sheets.
- Wide choice of heat sinks with thermal resistance ratings of 2.5 °C/W to 0.2 °C/W.

The SSP relay range comprises:

- **SSP1:** Single-phase panel mount solid state relays available with/without embedded thermal pad and smart diagnostic features, extended load output voltage of up to 660 V ~ and load current rating of 10 A to 125 A.
- **SSP3:** Three-phase panel mount solid state relays integrated with R-C snubber circuit, TVS (Transient Voltage Suppression), and load current ratings of 25 A and 50 A.

Relay description

SSP1 single-phase panel mount relays

- 1 Load output connection screw terminals
- 2 Control input connection screw terminals
- 3 Control input voltage LED indicator
- 4 Indication area for product label or markings
- 5 Smart diagnostic auxiliary input and alarm output
- 6 Load output LED indicator
- 7 Test button
- 8 Optional factory-fit thermal pad that is glued on the rear of the product

SSP3 three-phase panel mount relays

- 1 Load output connection screw terminals
- 2 Control input connection screw terminals
- 3 Control input voltage LED indicator
- 4 Optional factory-fit thermal pad that is glued on the rear of the product



SSP1D425BD

SSP1 single-phase solid state relays							
Relays with embedded thermal pad							
Switching	Voltage range		Load current range	Reference	Weight		
	Control input	Load output					
	V	V	A		kg/lb		
DC switching	= 3.5...32	= 1...150	12	SSP1D412BDT	0.089/0.196		
			25	SSP1D425BDT	0.089/0.196		
			40	SSP1D440BDT	0.089/0.196		
Zero voltage switching	= 3...32	~ 24...300	10	SSP1A110BDT	0.089/0.196		
			25	SSP1A125BDT	0.089/0.196		
			50	SSP1A150BDT	0.089/0.196		
	= 4...32	~ 48...660	75	SSP1A175BDT	0.089/0.196		
			50	SSP1A450BDT	0.089/0.196		
			75	SSP1A475BDT	0.089/0.196		
			90	SSP1A490BDT	0.089/0.196		
			125	SSP1A4125BDT	0.089/0.196		
			~ 90...280	~ 24...300	10	SSP1A110M7T	0.089/0.196
	25	SSP1A125M7T			0.089/0.196		
	50	SSP1A150M7T			0.089/0.196		
	75	SSP1A175M7T			0.089/0.196		
	~ 48...660				50	SSP1A450M7T	0.089/0.196
					75	SSP1A475M7T	0.089/0.196
			90	SSP1A490M7T	0.089/0.196		
		125	SSP1A4125M7T	0.089/0.196			
Relays without embedded thermal pad							
DC switching	= 3.5...32	= 1...150	12	SSP1D412BD	0.089/0.196		
			25	SSP1D425BD	0.089/0.196		
			40	SSP1D440BD	0.089/0.196		
Zero voltage switching	= 3...32	~ 24...300	10	SSP1A110BD	0.089/0.196		
			25	SSP1A125BD	0.089/0.196		
			50	SSP1A150BD	0.089/0.196		
	= 4...32	~ 48...660	75	SSP1A175BD	0.089/0.196		
			50	SSP1A450BD	0.089/0.196		
			75	SSP1A475BD	0.089/0.196		
			90	SSP1A490BD	0.089/0.196		
			125	SSP1A4125BD	0.089/0.196		
			~ 90...280	~ 24...300	25	SSP1A125M7	0.089/0.196
	50	SSP1A150M7			0.089/0.196		
	~ 48...660				50	SSP1A450M7	0.089/0.196
					75	SSP1A475M7	0.089/0.196
					90	SSP1A490M7	0.089/0.196
					125	SSP1A4125M7	0.089/0.196
	Relays with embedded thermal pad and smart diagnostic features						
Zero voltage switching	= 3...32	~ 24...300	25	SSP1A125BDS	0.097/0.214		
			50	SSP1A150BDS	0.097/0.214		
	= 4...32	~ 48...660	50	SSP1A450BDS	0.097/0.214		
			75	SSP1A475BDS	0.097/0.214		
			90	SSP1A490BDS	0.097/0.214		
			125	SSP1A4125BDS	0.097/0.214		



SSP1A125BDS

Harmony Solid State Relays

SSP solid state panel mount relays

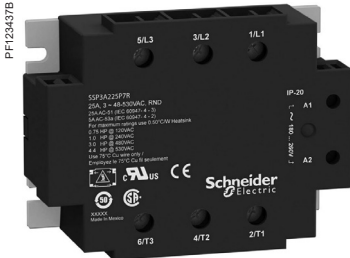

SSP3A225P7

SSP3 three-phase solid state relays					
Relays with embedded thermal pad					
Switching	Voltage range		Load current range	Reference	Weight
	Control Input	Load Output			
	V	V	A		kg/lb
Zero voltage switching	≡ 4...32	~ 48...530	25	SSP3A225BDT	0.240/0.529
			50	SSP3A250BDT	0.240/0.529
	~ 18...36	~ 48...530	50	SSP3A250B7T	0.240/0.529
			50	SSP3A225F7T	0.240/0.529
	~ 90...140	~ 48...530	25	SSP3A225F7T	0.240/0.529
			50	SSP3A250F7T	0.240/0.529
~ 180...280	~ 48...530	25	SSP3A225P7T	0.240/0.529	
		50	SSP3A250P7T	0.240/0.529	
Random switching	≡ 4...32	~ 48...530	25	SSP3A225BDRT	0.240/0.529
			50	SSP3A250BDRT	0.240/0.529
	~ 18...36	~ 48...530	50	SSP3A250B7RT	0.240/0.529
			50	SSP3A225F7RT	0.240/0.529
	~ 90...140	~ 48...530	50	SSP3A250F7RT	0.240/0.529
			50	SSP3A250P7RT	0.240/0.529
~ 180...280	~ 48...530	50	SSP3A250P7RT	0.240/0.529	
		50	SSP3A250P7RT	0.240/0.529	
Relays without embedded thermal pad					
Zero voltage switching	≡ 4...32	~ 48...530	25	SSP3A225BD	0.240/0.529
			50	SSP3A250BD	0.240/0.529
	~ 18...36	~ 48...530	25	SSP3A225B7	0.240/0.529
			50	SSP3A250B7	0.240/0.529
	~ 90...140	~ 48...530	25	SSP3A225F7	0.240/0.529
			50	SSP3A250F7	0.240/0.529
~ 180...280	~ 48...530	25	SSP3A225P7	0.240/0.529	
		50	SSP3A250P7	0.240/0.529	
Random switching	≡ 4...32	~ 48...530	25	SSP3A225BDR	0.240/0.529
			50	SSP3A250BDR	0.240/0.529
	~ 18...36	~ 48...530	25	SSP3A225B7R	0.240/0.529
			50	SSP3A250B7R	0.240/0.529
	~ 90...140	~ 48...530	50	SSP3A250F7R	0.240/0.529
			25	SSP3A225P7R	0.240/0.529
~ 180...280	~ 48...530	25	SSP3A225P7R	0.240/0.529	
		50	SSP3A250P7R	0.240/0.529	

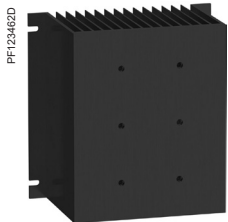

SSRHP05

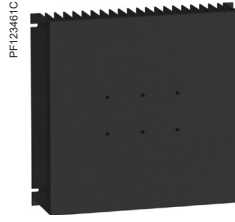

SSRHP02



SSRHP07

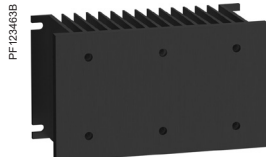

SSRHP10

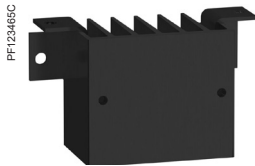

SSRHP25

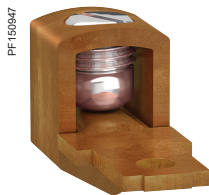

SSRAL1

Heat sinks for customer assembly

Mounting	Number and type of relays supported	Surface area	Thermal resistance	Reference	Weight
		cm ² /in ²	°C/W		
Panel mount	Up to 3 SSP1 units 1 SSP3 unit	6,823/1,058	0.2	SSRHP02	2.592/5.714
	Up to 3 SSP1 units 1 SSP3 unit	4,406/683	0.5	SSRHP05	1.440/3.174
	1 SSP1 unit	1,640/254	0.7	SSRHP07	0.526/1.159
	Up to 3 SSP1 units 1 SSP3 unit	1,425/221	1	SSRHP10	0.620/1.367
	1 SSP1 unit	336/52.10	2.5	SSRHP25	0.100/0.220
DIN rail mount	Up to 3 SSP1 units 1 SSP3 unit	1,425/221	1	SSRHD10	0.630/1.389

Accessories

Description	Type of relays supported	Unit reference	Weight kg/lb
Copper terminal lug for AWG 6 (13.3 mm ²) to AWG 0 (53.5 mm ²) Sold in lots of 10	SSP1	SSRAL1	0.042/0.093

Life Is On



Learn more about our products at
www.se.com/relays

The information provided in this documentation contains general descriptions and/or technical characteristics of the performance of the products contained herein. This documentation is not intended as a substitute for and is not to be used for determining suitability or reliability of these products for specific user applications. It is the duty of any such user or integrator to perform the appropriate and complete risk analysis, evaluation and testing of the products with respect to the relevant specific application or use thereof. Neither Schneider Electric nor any of its affiliates or subsidiaries shall be responsible or liable for misuse of the information contained herein.

Design: Schneider Electric
Photos: Schneider Electric

Schneider Electric Industries SAS

Head Office
35, rue Joseph Monier - CS 30323
F-92500 Rueil-Malmaison Cedex
France

DIA5ED2130302EN
March 2021 - V6.0