

Material Handling

Conveying M241

Project Template User Guide

10/2014



The information provided in this documentation contains general descriptions and/or technical characteristics of the performance of the products contained herein. This documentation is not intended as a substitute for and is not to be used for determining suitability or reliability of these products for specific user applications. It is the duty of any such user or integrator to perform the appropriate and complete risk analysis, evaluation and testing of the products with respect to the relevant specific application or use thereof. Neither Schneider Electric nor any of its affiliates or subsidiaries shall be responsible or liable for misuse of the information contained herein. If you have any suggestions for improvements or amendments or have found errors in this publication, please notify us.

No part of this document may be reproduced in any form or by any means, electronic or mechanical, including photocopying, without express written permission of Schneider Electric.

All pertinent state, regional, and local safety regulations must be observed when installing and using this product. For reasons of safety and to help ensure compliance with documented system data, only the manufacturer should perform repairs to components.

When devices are used for applications with technical safety requirements, the relevant instructions must be followed.

Failure to use Schneider Electric software or approved software with our hardware products may result in injury, harm, or improper operating results.

Failure to observe this information can result in injury or equipment damage.

© 2014 Schneider Electric. All rights reserved.

Table of Contents



	Safety Information	5
	About the Book.	9
Chapter 1	Conveying Application	11
	Introduction	12
	System Requirements	14
	Conveying System	15
	Operation of the Conveyor	17
	Application Functions	18
Chapter 2	Application Function Blocks	19
	Application Function Blocks	19
Chapter 3	Architecture	25
	Hardware Architecture	25
Chapter 4	Application Software	29
	Application Software	30
	Application Function Block Library	31
Chapter 5	Application Program	33
	Introduction	34
	Modicon M241 Logic Controller	35
	Magelis HMI XBTGT6340	38

Safety Information



Important Information

NOTICE

Read these instructions carefully, and look at the equipment to become familiar with the device before trying to install, operate, or maintain it. The following special messages may appear throughout this documentation or on the equipment to warn of potential hazards or to call attention to information that clarifies or simplifies a procedure.



The addition of this symbol to a “Danger” or “Warning” safety label indicates that an electrical hazard exists which will result in personal injury if the instructions are not followed.



This is the safety alert symbol. It is used to alert you to potential personal injury hazards. Obey all safety messages that follow this symbol to avoid possible injury or death.

DANGER

DANGER indicates a hazardous situation which, if not avoided, **will result in** death or serious injury.

WARNING

WARNING indicates a hazardous situation which, if not avoided, **could result in** death or serious injury.

CAUTION

CAUTION indicates a hazardous situation which, if not avoided, **could result in** minor or moderate injury.

NOTICE

NOTICE is used to address practices not related to physical injury.

PLEASE NOTE

Electrical equipment should be installed, operated, serviced, and maintained only by qualified personnel. No responsibility is assumed by Schneider Electric for any consequences arising out of the use of this material.

A qualified person is one who has skills and knowledge related to the construction and operation of electrical equipment and its installation, and has received safety training to recognize and avoid the hazards involved.

BEFORE YOU BEGIN

Do not use this product on machinery lacking effective point-of-operation guarding. Lack of effective point-of-operation guarding on a machine can result in serious injury to the operator of that machine.

WARNING

UNGUARDED EQUIPMENT

- Do not use this software and related automation equipment on equipment which does not have point-of-operation protection.
- Do not reach into machinery during operation.

Failure to follow these instructions can result in death, serious injury, or equipment damage.

This automation equipment and related software is used to control a variety of industrial processes. The type or model of automation equipment suitable for each application will vary depending on factors such as the control function required, degree of protection required, production methods, unusual conditions, government regulations, etc. In some applications, more than one processor may be required, as when backup redundancy is needed.

Only you, the user, machine builder or system integrator can be aware of all the conditions and factors present during setup, operation, and maintenance of the machine and, therefore, can determine the automation equipment and the related safeties and interlocks which can be properly used. When selecting automation and control equipment and related software for a particular application, you should refer to the applicable local and national standards and regulations. The National Safety Council's Accident Prevention Manual (nationally recognized in the United States of America) also provides much useful information.

In some applications, such as packaging machinery, additional operator protection such as point-of-operation guarding must be provided. This is necessary if the operator's hands and other parts of the body are free to enter the pinch points or other hazardous areas and serious injury can occur. Software products alone cannot protect an operator from injury. For this reason the software cannot be substituted for or take the place of point-of-operation protection.

Ensure that appropriate safeties and mechanical/electrical interlocks related to point-of-operation protection have been installed and are operational before placing the equipment into service. All interlocks and safeties related to point-of-operation protection must be coordinated with the related automation equipment and software programming.

NOTE: Coordination of safeties and mechanical/electrical interlocks for point-of-operation protection is outside the scope of the Function Block Library, System User Guide, or other implementation referenced in this documentation.

START-UP AND TEST

Before using electrical control and automation equipment for regular operation after installation, the system should be given a start-up test by qualified personnel to verify correct operation of the equipment. It is important that arrangements for such a check be made and that enough time is allowed to perform complete and satisfactory testing.

CAUTION

EQUIPMENT OPERATION HAZARD

- Verify that all installation and set up procedures have been completed.
- Before operational tests are performed, remove all blocks or other temporary holding means used for shipment from all component devices.
- Remove tools, meters, and debris from equipment.

Failure to follow these instructions can result in injury or equipment damage.

Follow all start-up tests recommended in the equipment documentation. Store all equipment documentation for future references.

Software testing must be done in both simulated and real environments.

Verify that the completed system is free from all short circuits and temporary grounds that are not installed according to local regulations (according to the National Electrical Code in the U.S.A, for instance). If high-potential voltage testing is necessary, follow recommendations in equipment documentation to prevent accidental equipment damage.

Before energizing equipment:

- Remove tools, meters, and debris from equipment.
- Close the equipment enclosure door.
- Remove all temporary grounds from incoming power lines.
- Perform all start-up tests recommended by the manufacturer.

OPERATION AND ADJUSTMENTS

The following precautions are from the NEMA Standards Publication ICS 7.1-1995 (English version prevails):

- Regardless of the care exercised in the design and manufacture of equipment or in the selection and ratings of components, there are hazards that can be encountered if such equipment is improperly operated.
- It is sometimes possible to misadjust the equipment and thus produce unsatisfactory or unsafe operation. Always use the manufacturer's instructions as a guide for functional adjustments. Personnel who have access to these adjustments should be familiar with the equipment manufacturer's instructions and the machinery used with the electrical equipment.
- Only those operational adjustments actually required by the operator should be accessible to the operator. Access to other controls should be restricted to prevent unauthorized changes in operating characteristics.

About the Book



At a Glance

Document Scope

This document describes a conveying application based on Modicon M251 Logic Controller. This document is an example of an application used to control a conveyor.

This manual is intended for use by individuals knowledgeable and experienced in material handling technologies.

The following basic knowledge is required:

- basic information on functionality, structure, and configuration of the controllers, drives, and HMI displays
- programming languages: IL, ST, FBD, SFC, LD, CFC

Validity Note

This document has been created with the release of SoMachine V4.1 Material Handling add-on.

Related Documents

Title of Documentation	Reference Number
SoMachine Programming Guide	EIO0000000069
SoMachine, Conveying Application Functions, Conveying Library Guide	EIO0000000201

You can download these technical publications and other technical information from our website at www.schneider-electric.com.

Product Related Information

WARNING

LOSS OF CONTROL

- The designer of any control scheme must consider the potential failure modes of control paths and, for certain critical control functions, provide a means to achieve a safe state during and after a path failure. Examples of critical control functions are emergency stop and overtravel stop, power outage and restart.
- Separate or redundant control paths must be provided for critical control functions.
- System control paths may include communication links. Consideration must be given to the implications of unanticipated transmission delays or failures of the link.
- Observe all accident prevention regulations and local safety guidelines.¹
- Each implementation of this equipment must be individually and thoroughly tested for proper operation before being placed into service.

Failure to follow these instructions can result in death, serious injury, or equipment damage.

¹ For additional information, refer to NEMA ICS 1.1 (latest edition), "Safety Guidelines for the Application, Installation, and Maintenance of Solid State Control" and to NEMA ICS 7.1 (latest edition), "Safety Standards for Construction and Guide for Selection, Installation and Operation of Adjustable-Speed Drive Systems" or their equivalent governing your particular location.

WARNING

UNINTENDED EQUIPMENT OPERATION

- Only use software approved by Schneider Electric for use with this equipment.
- Update your application program every time you change the physical hardware configuration.

Failure to follow these instructions can result in death, serious injury, or equipment damage.

User Comments

We welcome your comments about this document. You can reach us by e-mail at techcomm@schneider-electric.com.

Chapter 1

Conveying Application

What Is in This Chapter?

This chapter contains the following topics:

Topic	Page
Introduction	12
System Requirements	14
Conveying System	15
Operation of the Conveyor	17
Application Functions	18

Introduction

This document is intended to provide a quick introduction and programming example to the described application. It is not intended to replace any specific product documentation, nor any of your own design documentation. On the contrary, it offers additional information to the product documentation for installing, configuring and implementing the application.

The architecture described in this document is not a specific product in the normal commercial sense. It describes an example of how Schneider Electric and third-party components may be integrated to fulfil an industrial application. A detailed functional description or the specification for a specific user application is not part of this document.

Your specific application requirements can be different and will require additional and/or different components, configuration and/or programming logic than that is found in this document. In that case, you will have to adapt the information provided in this document to your particular needs. In all and any cases, pay particular attention in conforming to any safety information, different electrical requirements and normative standards that would apply to your adaptation.

WARNING

REGULATORY INCOMPATIBILITY

Be sure that all equipment applied and systems designed comply with all applicable local, regional and national regulations and standards.

Failure to follow these instructions can result in death, serious injury, or equipment damage.

NOTE: There are some major logical and physical components in the application example described herein. They cannot be substituted without completely invalidating the architecture, descriptions, instructions, wiring diagrams and compatibility between the various software and hardware components specified in this document. You must be aware of the consequences of component substitutions or modifications in the architecture described in this document as they can impair the compatibility and interoperability of software and hardware.

A residual risk, as defined by EN/ISO 12100-1, Article 5, will remain if:

- it is necessary to modify the recommended logic and if the added or modified components are not properly integrated in the control circuit.
- you do not follow the required standards applicable to the operation of the machine, or if the adjustments to and the maintenance of the machine are not properly made (it is essential to strictly follow the prescribed machine maintenance schedule).
- the devices connected to any safety outputs do not have mechanically-linked contacts.

 **CAUTION**

EQUIPMENT INCOMPATIBILITY

Read and thoroughly understand all device and software documentation before attempting any component substitutions or other changes related to the application examples provided in the document.

Failure to follow these instructions can result in injury or equipment damage.

System Requirements

Using the Library

WARNING

UNINTENDED EQUIPMENT OPERATION

- Verify the SoMachine libraries contained in your program are the correct version after updating SoMachine software.
- Verify that the library versions updated are consistent with your application specifications.

Failure to follow these instructions can result in death, serious injury, or equipment damage.

For more detailed information, see Schneider Electric Libraries (*see SoMachine, Functions and Libraries User Guide*).

For IEC 61131-3 compatibility, the ability to add the EN/ENO input/output automatically to Function Blocks of certain programming languages is available to the programmer. However, for certain applications that require the complex interaction of multiple function blocks, the use of the IEC 61131-3 input to disable a function block in a series of interrelated functions affecting a process may lead to unintended operation of the system as a whole. For the functions contained in the Library that is the topic of the current document, this is especially true.

The EN/ENO inputs and outputs as defined by IEC 61131-3 are maladapted to, and therefore inappropriate for, the targeted application of these functions. Suddenly disabling one function by a falling edge on the EN input would require all outputs of the function block to immediately fall to their default states, and such an unanticipated action would cause an abrupt change to the entire process. The implication is that such an event would have deleterious results that may invoke undesirable consequences. Therefore, the EN/ENO inputs/outputs as defined by IEC 61131-3 are incompatible with the functions contained within this library.

WARNING

UNINTENDED MACHINE OPERATION

Do not use the EN/ENO functionality defined by IEC 61131-3 to control the behavior of the Application Function blocks.

Failure to follow these instructions can result in death, serious injury, or equipment damage.

NOTE: Verify that the EN/ENO option is disabled in the compiler options menu of SoMachine.

Conveying System

Overview

This project template realizes an example of a conveying zone by embedding the functions provided with the Conveying library.

Conveying Example

The following illustration presents an example of the physical positioning of the different conveyor equipment in a conveying management system.

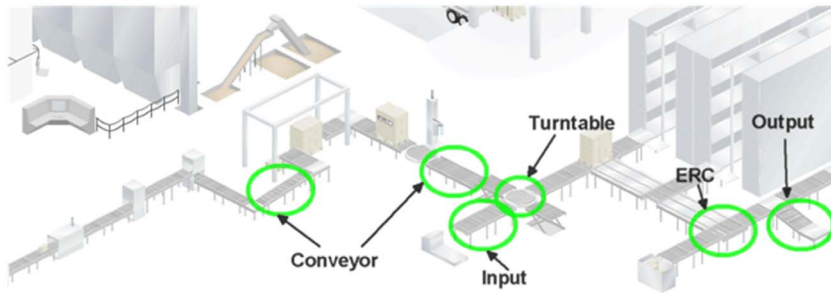

This example describes a conveyor with an application based on the conveying function block library.

The hardware components for controlling a zone are comprised of a cabinet and distributed/local input/output units (I/O). The cabinet houses the Modicon M241 Logic Controller with local I/O and a Magelis XBTGT HMI system for controlling and managing the conveying zone. The motor control for a given mechanical equipment is partially interfaced by the distributed I/O and partially by the local I/O. The logic controller housed in the cabinet communicates with the distributed I/O units through the CANopen fieldbus.

This conveying example uses two types of application function blocks (AFB):

- Machine functions
- Transverse functions

The conveying application running on the Modicon M241 Logic Controller includes these machine application function blocks:

Machine Functions	AFB Name
Conveyor	Conveyor
Input conveyor	Input
Output conveyor	Output
Turntable	Turntable
Transfer table (Eccentric Roller Conveyor)	ERC

The conveying application running on the Modicon M241 Logic Controller includes these transverse application function blocks:

Transverse Functions	AFB Name
Interface with HMI	DeskzoneCmpx DeskzoneSimp
Alarm handling	AlrmHdlg
Tracking	TrckCmpx TrckSimp

Operation of the Conveyor

Overview

The conveying architecture described herein implements the main functions of a typical conveying system used for transporting boxes or pallets.

During the transfer of a box or pallet across several different mechanical equipments, coordinate drift may arise due to variations in speed, direction, modes, handshaking and tracking information with ordinary conveying technology. This can result in the box or pallet being damaged or not being transferred to the subsequent conveyor. The application function blocks contained in the SoMachine Conveying library improve coherency during the transfer of a box or pallet between mechanical equipments.

Each application function block (AFB) is able to manage each mechanical conveyor equipment for one box or pallet at a time.

Application Functions

Overview

This project application template includes a combination of function blocks, fulfilling several application and device functions. It does not provide a complete user program for a conveying management system.

Chapter 2

Application Function Blocks

Application Function Blocks

Overview

Each application function block (AFB) uses a data structure to combine data of the same origin or destination. The element, and the element names of the structures, support easy mapping.

The AFBs can have three operation modes:

- **Auto Mode:** The function block automatically controls the equipment without operator intervention.
- **Manual Mode:** An operator controls the equipment by remote commands through an HMI. The logic controller still monitors the system.
- **Local Mode:**
 - The operator controls the equipment locally through the local panel.
 - The operator can power down the equipment and perform maintenance.

Each machine function provides status to the conveyor equipment in the form of alarms and alert messages. These functions have unique identification bits into a word array.

Each machine function has an input structure linked to the external diagnostic signals, such as protection switch, drive or hardware diagnostic.

The tracking information is passed to the conveying system logic controller, when the box or pallet is conveyed. The tracking information of the box or pallet moving on the conveyor is passed from the AFB to another for each equipment trasversed by the box or pallet.

This function (tracking information movement) is controlled by transverse AFBs called `TrckSimp` (tracking simple) or `TrckCmpx` (tracking complex). The `TrckCmpx` AFB supports the Turntable or ERC function block through detecting and handling the destination address of the box or pallet.

All machine function blocks are able to generate alarms or alerts for the operator. `AlrmHdlg`, `DeskzoneCmpx` and `DeskzoneSimp` AFBs manage the information.

For more information, refer to the online help of the function blocks in SoMachine.

Conveyor AFB

The `Conveyor` application function block can manage a conveyor at two speeds and two directions. One `Conveyor` AFB manages one box or pallet at a given time for a given equipment. The handshaking mechanism helps to provide a smooth flow of the box or pallet across conveyor junctions.

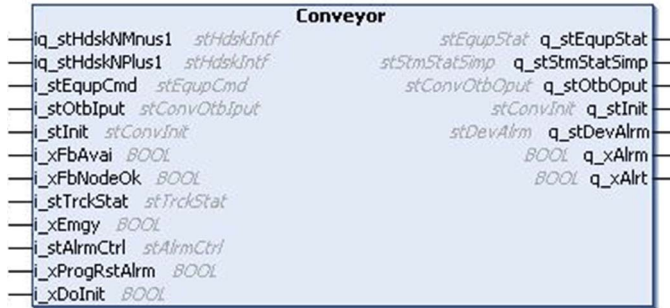

Input AFB

The `Input` application function block controls the loading process of a box or pallet into an entry point of the conveyor system.

The input function leads a forklift with the help of a beacon. For example, by a green light, the forklift places a box or a pallet on the conveyor.

When a pallet is on the conveyor, an operator initiates the loading operation of the entry conveyor through an acknowledge command.

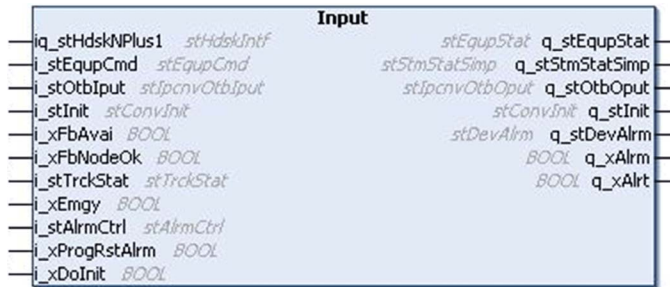

Output AFB

The **Output** application function block controls the unloading process of a box or pallet from an output point of the conveying system.

The output function leads a forklift with the help of a beacon. For example, by a green light, the forklift can take a box or a pallet from the conveyor.

An inductive loop sensor detects the arrival of a forklift truck. If the pallet is ready to unload, the beacon presents a green light.

When the box or pallet is unloaded, an operator finishes the process through an acknowledge command.

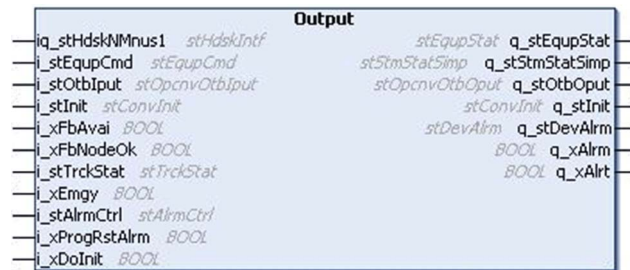

Turntable AFB

The **Turntable** application function block can manage the direction and speed of the motors within a turntable conveyor. The turntable function synchronizes the conveyor with the surrounding conveyors (to conveyor 360°, 90°, 180°, 270°) through handshake signals.

The turntable function uses the tracking information or a word input value to acknowledge the destination of the box or pallet.

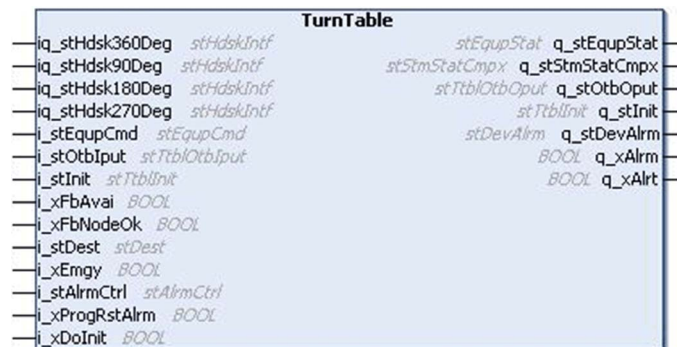

Eccentric Roller Conveyor AFB

The `ERC` application function block automates an ERC (Eccentric Roller Conveyor) in a longitudinal or transverse direction. It manages the speed, and direction of the motors or gear for the two monitored conveyors and the vertical position of the roller conveyor.

The ERC function synchronizes the conveyor with the surrounding conveyors (to conveyor 360°, to conveyor 90°, to conveyor 180°, to conveyor 270°) through handshake signals.

The ERC function manages the transport of a box or pallet on bi-directional conveyors at two different speeds. The ERC moves forward or reverse based on the source (detected by handshake signals) and on the destination (word input value or part of the tracking information).

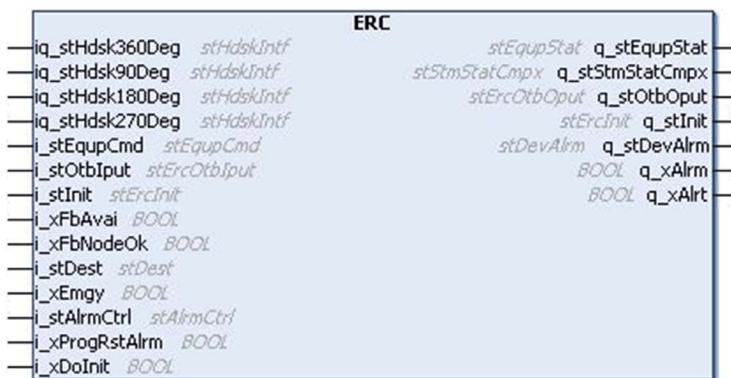

DeskzoneCmpx AFB and DeskzoneSimp AFB

This function realizes a standard interface between the conveying application (logic controller) and the visualization (HMI).

The AFB provides the following features:

- Monitoring identifiers status: verify the status of all identifiers during runtime, including alarm handling and alerts.
- Operating mode management: set all equipment to auto or manual mode based on an operating mode switch.

You can manage up to 25 conveying units collected in one zone with the Deskzone AFB and one HMI.

As an addition to the `DeskzoneSimp`, the `DeskzoneCmpx` verifies whether the equipment AFB identifier is equal to the corresponding tracking AFB identifier. In case of data inconsistency, it generates an alarm.



AlrmHdlg AFB

The AlrmHdlg function block provides the following features:

- Monitors alarm and alert status of the connected equipment AFBs, the tracking AFBs and the Deskzone AFB collected on one zone.
- Generates unique alarm or/and alert IDs for up to 25 equipment.
- Allocates a data information field with up to 100 historical alarm reports including alarm messages and time stamps.
- Commands alarm reset from the HMI to the connected equipment AFBs.
- Converts all alarm, and alert events to an ASCII code, and stores them in a data field.

NOTE: You may need to enable this feature before use.

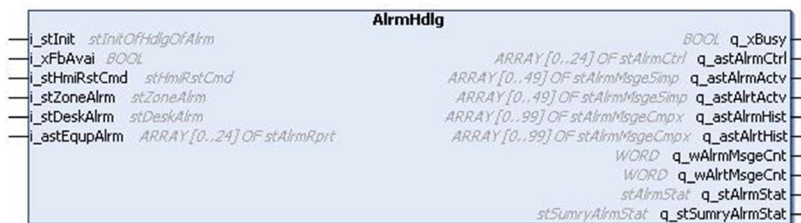

TrckCmpx and TrckSimp AFB

This function tracks informations of the box through a conveyor system.

As an addition of `TrckSimple`, `TrckCmpx` detects the destination address of the box or pallet with the help of tracking data field.

For complex equipment requiring information about the destination of the box or pallet such as a turntable or an ERC use `TrckCmpx` AFB.

For simple equipment, such as a conveyor, an input conveyor or an output conveyor, use `TrckSimp` AFB.



Chapter 3

Architecture

Hardware Architecture

Overview

This application uses a Modicon M241 Logic Controller. You can use the Magelis XBTGT6340 HMI to operate and monitor the conveyor application. The TM7 distributed I/O modules communicate with the controller through CANopen fieldbus. The motors and sensors are connected to both the local I/O and the TM7 distributed I/O modules.

This example conveyor is designed to have the different equipment of a conveyor system supported by the Conveying library in one example architecture.

It is not intended to mirror any real conveyor architecture.

Example of a Project System Configuration

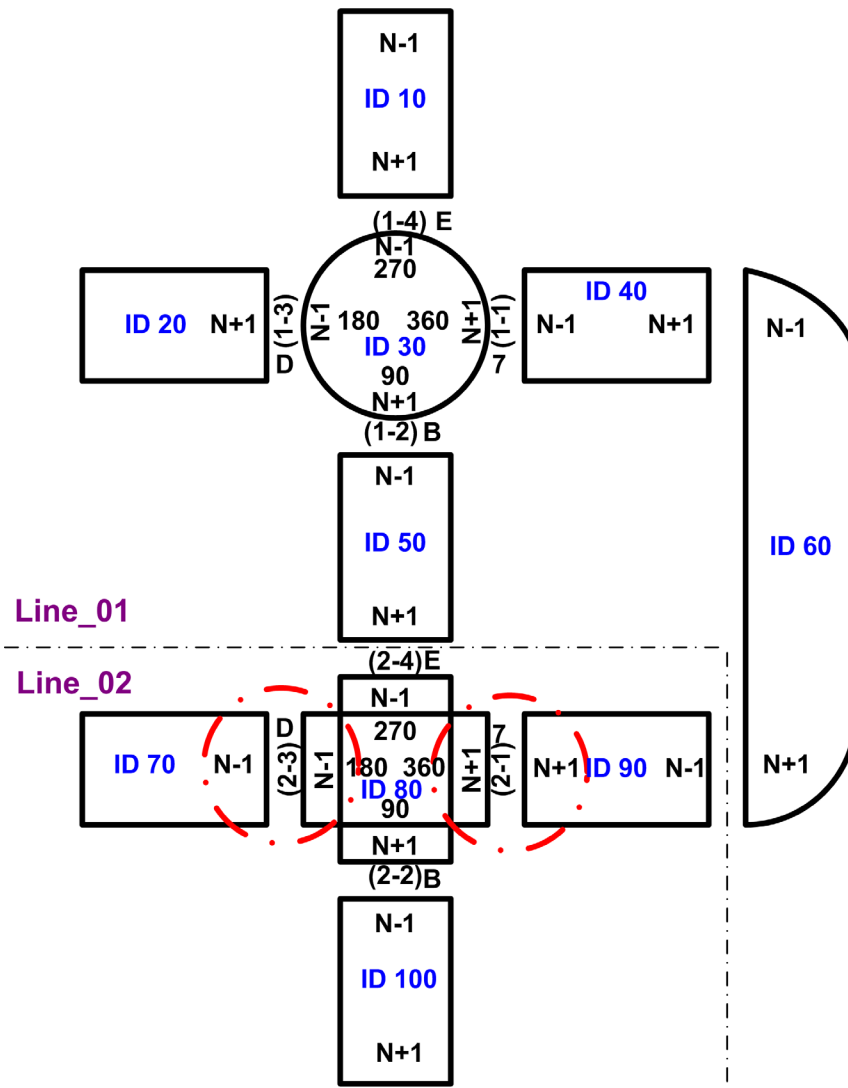

NOTE:

N-1 to N+1 indicates the forward direction.

The red circles indicate a point of changed direction (N-1 to N-1 or N+1 to N+1).

For a detailed description, refer to the online help of the Conveying library in SoMachine.

The table below lists the IDs used for the different equipment:

Equipment ID	Description
10, 40, 50, 60, 90, 100	Standard conveyors
20	Input conveyor
30	Turntable unit
70	Output conveyor
80	ERC unit (transfer table)

NOTE: The Conveying library is designed to have the equipment ID as parameter variable on the corresponding AFB. The equipment ID variable has the data type WORD.

Chapter 4

Application Software

What Is in This Chapter?

This chapter contains the following topics:

Topic	Page
Application Software	30
Application Function Block Library	31

Application Software

Overview

Use SoMachine programming environment for the following tasks:

- Program the Modicon M241 Logic Controller.
- Configure the Modbus TCP/IO scanner.
- Create the panels for the Magelis HMI XBT6340 display. Use Vijeo Designer to develop HMI screens for Magelis HMI XBTGT6340.

NOTE: Vijeo Designer software is integrated in SoMachine.

Application Function Block Library

Overview

The Conveying library is intended for conveying management systems and has the following functions:

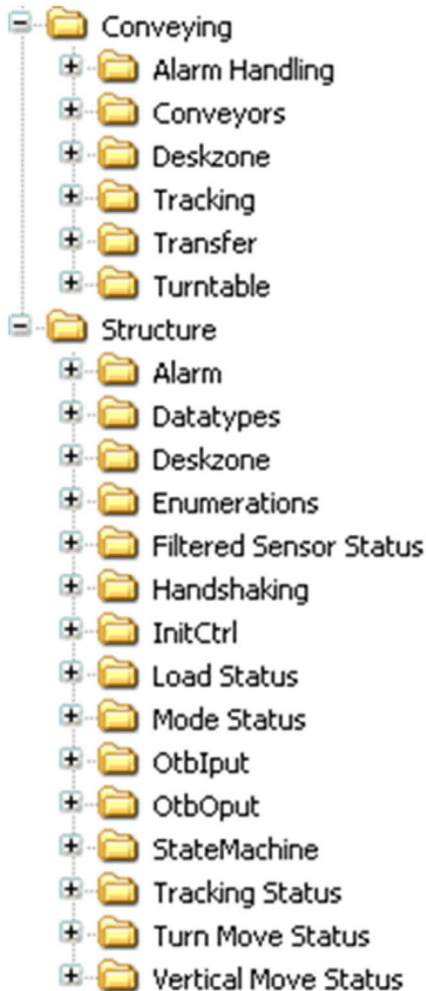

For a detailed description, refer to the online help of the Conveying library in SoMachine.

Chapter 5

Application Program

Overview

This chapter describes the logic controller application and the HMI application.

What Is in This Chapter?

This chapter contains the following topics:

Topic	Page
Introduction	34
Modicon M241 Logic Controller	35
Magelis HMI XBTGT6340	38

Introduction

Overview

This application uses the CANopen fieldbus and uses SoMachine protocol over Ethernet.

Use CANopen to connect the following devices:

- one Modicon M241 Logic Controller with one CANopen bus connector.
- CANopen node addresses, for example 11 to 43.

The SoMachine protocol connects the Magelis HMI XBTGT6340 with the Modicon M241 Logic Controller.

Modicon M241 Logic Controller

Overview

The following description presents the project parts of the conveying application.

The project parts include:

- Application tree
- Device tree

Application Tree

The conveying (PRG) invokes some program tasks.

The main tasks for the equipment programs are:

- Conv_Line_01 (PRG)
- Conv_Line_02 (PRG)

These two PRGs manage the conveyor equipments. All AFBs linked to the equipments are inside these two PRGs.

The main task for the HMI link program is:

DeskZone (PRG)

This program manages the communication with the local HMI to operate and monitor the conveyor application.

The others are auxiliary tasks:

- MappHMIRef (PRG)
- MappStatusToHMI (PRG)

Postprocessing (PRG) with an action routine:

- A_OTB_Output_Map

Preprocessing (PRG) with action routines:

- A_Plant_Status
- A_Plant_Staus_Line_01
- A_Plant_Staus_Line_02
- A_OTB_Input_Map
- A_CAN_State_Control

Device Tree

The main devices are:

- M241 controller
- TM3 IO modules
- TM7 CANopen IO devices

Application Overview

SoMachine Logic Controller Application	Logic Controller Application Device View
<ul style="list-style-type: none"> Application (MyConveyingController) <ul style="list-style-type: none"> Conv_Line_01 (PRG) Conv_Line_02 (PRG) DeskZone (PRG) GVL <ul style="list-style-type: none"> GVL GVL_Alarm GVL_CAN GVL_HarmonyWireless_MdbSL GVL_HMI GVL_Instance GVL_ModBusTCP GVL_SIM HarmonyWirelessPushButton (PRG) MappHMIRef (PRG) MappStatusToHMI (PRG) MappToModbus (PRG) Postprocessing (PRG) <ul style="list-style-type: none"> A_OutputMapping Preprocessing (PRG) <ul style="list-style-type: none"> A_CAN_State_Control A_Initialization A_InputMapping A_OTB_Input A_Plant_Status A_Plant_Status_Line_01 A_Plant_Status_Line_02 sfbHmi stHmiStructures Task Configuration <ul style="list-style-type: none"> MAST <ul style="list-style-type: none"> MappHMIRef Preprocessing HarmonyWirelessPushButton DeskZone Conv_Line_01 Conv_Line_02 Postprocessing MappStatusToHMI 	<ul style="list-style-type: none"> Material_Handling_Conveying <ul style="list-style-type: none"> ConvHmi01 (XBTGT6340) <ul style="list-style-type: none"> COM1 COM2 Ethernet USB FdtConnections (FDT Connections) <ul style="list-style-type: none"> Modbus_Serial_Line_Manager (Modbus Serial Line Manager) MyConveyingController (TM241CEC24T/U) <ul style="list-style-type: none"> DI (Digital Inputs) DQ (Digital Outputs) Counters (Counters) Pulse_Generators (Pulse Generators) Cartridge_1 (Cartridge) IO_Bus (IO bus - TM3) <ul style="list-style-type: none"> Module_4 (TM35AK6R/G) Module_5 (TM35AK6R/G) Module_1 (TM3D116/G) Module_6 (TM3DM24R/G) Module_7 (TM3DQ16T/G) Module_8 (TM3AM6/G) Module_2 (TM3DM24R/G) COM_Bus (COM bus) Ethernet_1 (Ethernet Network) Serial_Line_1 (Serial line) Serial_Line_2 (Serial line) CAN_1 (CANopen bus) <ul style="list-style-type: none"> CANopen_Performance (CANopen Performance) <ul style="list-style-type: none"> TM7_Conveyor_ID_10 (TM7NCOM16B Interface) <ul style="list-style-type: none"> TM7BDM16BE_1 (TM7BDM16BE) TM7_Input_Conveyor_ID_20 (TM7NCOM16B Interface) <ul style="list-style-type: none"> TM7BDM16BE_2 (TM7BDM16BE) TM7_TurnTable_Conveyor_ID_30 (TM7NCOM16B Interface) <ul style="list-style-type: none"> TM7BDM16BE_3 (TM7BDM16BE) TM7_Conveyor_ID_40 (TM7NCOM16B Interface) <ul style="list-style-type: none"> TM7BDM16BE_4 (TM7BDM16BE) TM7_Conveyor_ID_50 (TM7NCOM16B Interface) <ul style="list-style-type: none"> TM7BDM16BE_5 (TM7BDM16BE) TM7_Conveyor_ID_60 (TM7NCOM16B Interface) <ul style="list-style-type: none"> TM7BDM16BE_6 (TM7BDM16BE) TM7_Output_Conveyor_ID_70 (TM7NCOM16B Interface) <ul style="list-style-type: none"> TM7BDM16BE_7 (TM7BDM16BE) TM7_ERC_Conveyor_ID_80 (TM7NCOM16B Interface) <ul style="list-style-type: none"> TM7BDM16BE_8 (TM7BDM16BE) TM7_Conveyor_ID_90 (TM7NCOM16B Interface) <ul style="list-style-type: none"> TM7BDM16BE_9 (TM7BDM16BE) TM7_Conveyor_ID_100 (TM7NCOM16B Interface) <ul style="list-style-type: none"> TM7BDM16BE_10 (TM7BDM16BE)

The I/Os of the 10 equipment are linked to the following devices:

- local I/Os of the Modicon M241 Logic Controller, used for system relevant information
- local I/Os of the attached 7 x TM3 modules, used for motor / VSD relevant information
- distributed I/Os of the 10 x TM7 devices linked to the CANopen bus, used for DI / DO of the equipment, which are not motor / VSD relevant.

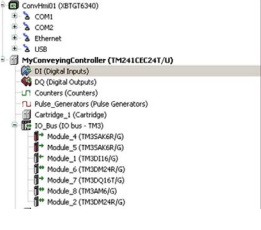
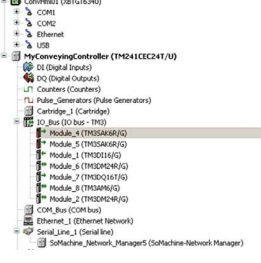
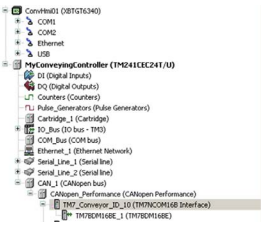
I/O Modules																																																																																																																																																																																									
<p>Local digital inputs of the Modicon M241 Logic Controller</p>	 <table border="1" data-bbox="617 381 1179 609"> <thead> <tr> <th>Variable</th> <th>Mapping</th> <th>Channel</th> <th>Address</th> <th>Type</th> <th>Default Value</th> <th>Link</th> <th>Description</th> </tr> </thead> <tbody> <tr> <td colspan="8">Inputs</td> </tr> <tr> <td>L_OnOff_Corr_ID_10</td> <td></td> <td>I20</td> <td>%I20.0</td> <td>BOOL</td> <td></td> <td></td> <td>Fast input, Sink/Source</td> </tr> <tr> <td>L_Motor_Corr_ID_10</td> <td></td> <td>I11</td> <td>%I10.1</td> <td>BOOL</td> <td></td> <td></td> <td>Fast input, Sink/Source</td> </tr> <tr> <td>L_Switch_to_Manual_Mode</td> <td></td> <td>I2</td> <td>%I10.2</td> <td>BOOL</td> <td></td> <td></td> <td>Fast input, Sink/Source</td> </tr> <tr> <td>L_Stop_Line_01_Circuit_01</td> <td></td> <td>I3</td> <td>%I10.3</td> <td>BOOL</td> <td></td> <td></td> <td>Fast input, Sink/Source</td> </tr> <tr> <td>L_Stop_Line_01_Circuit_02</td> <td></td> <td>I4</td> <td>%I10.4</td> <td>BOOL</td> <td></td> <td></td> <td>Fast input, Sink/Source</td> </tr> <tr> <td>L_Main_24Vdc_OK</td> <td></td> <td>I5</td> <td>%I10.5</td> <td>BOOL</td> <td></td> <td></td> <td>Fast input, Sink/Source</td> </tr> <tr> <td>L_Switch_to_Automatic_Mode</td> <td></td> <td>I6</td> <td>%I10.6</td> <td>BOOL</td> <td></td> <td></td> <td>Fast input, Sink/Source</td> </tr> <tr> <td>L_Stop_Line_02_Circuit_01</td> <td></td> <td>I7</td> <td>%I10.7</td> <td>BOOL</td> <td></td> <td></td> <td>Fast input, Sink/Source</td> </tr> <tr> <td>L_Stop_Line_02_Circuit_02</td> <td></td> <td>I8</td> <td>%I10.8</td> <td>BOOL</td> <td></td> <td></td> <td>Regular input, Sink/Source</td> </tr> <tr> <td>L_24Vdc_Power_IO_Device_OK</td> <td></td> <td>I9</td> <td>%I10.1</td> <td>BOOL</td> <td></td> <td></td> <td>Regular input, Sink/Source</td> </tr> <tr> <td>L_Motor_Corr_ID_10</td> <td></td> <td>I10</td> <td>%I10.2</td> <td>BOOL</td> <td></td> <td></td> <td>Regular input, Sink/Source</td> </tr> <tr> <td>L_Motor_Corr_ID_10</td> <td></td> <td>I11</td> <td>%I10.3</td> <td>BOOL</td> <td></td> <td></td> <td>Regular input, Sink/Source</td> </tr> <tr> <td>L_100Vdc_Power_Line_01_OK</td> <td></td> <td>I12</td> <td>%I10.4</td> <td>BOOL</td> <td></td> <td></td> <td>Regular input, Sink/Source</td> </tr> <tr> <td>L_100Vdc_Power_Line_02_OK</td> <td></td> <td>I13</td> <td>%I10.5</td> <td>BOOL</td> <td></td> <td></td> <td>Regular input, Sink/Source</td> </tr> <tr> <td>I81</td> <td></td> <td>I81</td> <td>%I81.0</td> <td>BYTE</td> <td></td> <td></td> <td></td> </tr> <tr> <td>I82</td> <td></td> <td>I82</td> <td>%I82.0</td> <td>BOOL</td> <td></td> <td></td> <td>Diagnostic of the outputs, default detec...</td> </tr> </tbody> </table>	Variable	Mapping	Channel	Address	Type	Default Value	Link	Description	Inputs								L_OnOff_Corr_ID_10		I20	%I20.0	BOOL			Fast input, Sink/Source	L_Motor_Corr_ID_10		I11	%I10.1	BOOL			Fast input, Sink/Source	L_Switch_to_Manual_Mode		I2	%I10.2	BOOL			Fast input, Sink/Source	L_Stop_Line_01_Circuit_01		I3	%I10.3	BOOL			Fast input, Sink/Source	L_Stop_Line_01_Circuit_02		I4	%I10.4	BOOL			Fast input, Sink/Source	L_Main_24Vdc_OK		I5	%I10.5	BOOL			Fast input, Sink/Source	L_Switch_to_Automatic_Mode		I6	%I10.6	BOOL			Fast input, Sink/Source	L_Stop_Line_02_Circuit_01		I7	%I10.7	BOOL			Fast input, Sink/Source	L_Stop_Line_02_Circuit_02		I8	%I10.8	BOOL			Regular input, Sink/Source	L_24Vdc_Power_IO_Device_OK		I9	%I10.1	BOOL			Regular input, Sink/Source	L_Motor_Corr_ID_10		I10	%I10.2	BOOL			Regular input, Sink/Source	L_Motor_Corr_ID_10		I11	%I10.3	BOOL			Regular input, Sink/Source	L_100Vdc_Power_Line_01_OK		I12	%I10.4	BOOL			Regular input, Sink/Source	L_100Vdc_Power_Line_02_OK		I13	%I10.5	BOOL			Regular input, Sink/Source	I81		I81	%I81.0	BYTE				I82		I82	%I82.0	BOOL			Diagnostic of the outputs, default detec...																																								
Variable	Mapping	Channel	Address	Type	Default Value	Link	Description																																																																																																																																																																																		
Inputs																																																																																																																																																																																									
L_OnOff_Corr_ID_10		I20	%I20.0	BOOL			Fast input, Sink/Source																																																																																																																																																																																		
L_Motor_Corr_ID_10		I11	%I10.1	BOOL			Fast input, Sink/Source																																																																																																																																																																																		
L_Switch_to_Manual_Mode		I2	%I10.2	BOOL			Fast input, Sink/Source																																																																																																																																																																																		
L_Stop_Line_01_Circuit_01		I3	%I10.3	BOOL			Fast input, Sink/Source																																																																																																																																																																																		
L_Stop_Line_01_Circuit_02		I4	%I10.4	BOOL			Fast input, Sink/Source																																																																																																																																																																																		
L_Main_24Vdc_OK		I5	%I10.5	BOOL			Fast input, Sink/Source																																																																																																																																																																																		
L_Switch_to_Automatic_Mode		I6	%I10.6	BOOL			Fast input, Sink/Source																																																																																																																																																																																		
L_Stop_Line_02_Circuit_01		I7	%I10.7	BOOL			Fast input, Sink/Source																																																																																																																																																																																		
L_Stop_Line_02_Circuit_02		I8	%I10.8	BOOL			Regular input, Sink/Source																																																																																																																																																																																		
L_24Vdc_Power_IO_Device_OK		I9	%I10.1	BOOL			Regular input, Sink/Source																																																																																																																																																																																		
L_Motor_Corr_ID_10		I10	%I10.2	BOOL			Regular input, Sink/Source																																																																																																																																																																																		
L_Motor_Corr_ID_10		I11	%I10.3	BOOL			Regular input, Sink/Source																																																																																																																																																																																		
L_100Vdc_Power_Line_01_OK		I12	%I10.4	BOOL			Regular input, Sink/Source																																																																																																																																																																																		
L_100Vdc_Power_Line_02_OK		I13	%I10.5	BOOL			Regular input, Sink/Source																																																																																																																																																																																		
I81		I81	%I81.0	BYTE																																																																																																																																																																																					
I82		I82	%I82.0	BOOL			Diagnostic of the outputs, default detec...																																																																																																																																																																																		
<p>Local TM3 I/O expansion modules</p>	 <table border="1" data-bbox="617 641 1179 901"> <thead> <tr> <th>Variable</th> <th>Mapping</th> <th>Channel</th> <th>Address</th> <th>Type</th> <th>D...</th> <th>Link</th> <th>Description</th> </tr> </thead> <tbody> <tr> <td colspan="8">Diagnostics</td> </tr> <tr> <td>I20</td> <td></td> <td>I20</td> <td>%I20.0</td> <td>WORD</td> <td></td> <td></td> <td></td> </tr> <tr> <td>qIModule_1_OutputOn</td> <td></td> <td>OutputOn</td> <td>%M14.0</td> <td>BOOL</td> <td></td> <td></td> <td>Safety output on</td> </tr> <tr> <td>qIModule_1_Supply</td> <td></td> <td>Supply</td> <td>%M14.1</td> <td>BOOL</td> <td></td> <td></td> <td>Supply available (AIJ2)</td> </tr> <tr> <td>qIModule_1_SupplyFail</td> <td></td> <td>SupplyFail</td> <td>%M14.2</td> <td>BOOL</td> <td></td> <td></td> <td>Supply out of tolerance</td> </tr> <tr> <td>qIModule_1_CH1</td> <td></td> <td>CH1</td> <td>%M14.3</td> <td>BOOL</td> <td></td> <td></td> <td>Channel 1 active</td> </tr> <tr> <td>qIModule_1_CH2</td> <td></td> <td>CH2</td> <td>%M14.4</td> <td>BOOL</td> <td></td> <td></td> <td>Channel 2 active</td> </tr> <tr> <td>qIModule_1_Start</td> <td></td> <td>Start</td> <td>%M14.5</td> <td>BOOL</td> <td></td> <td></td> <td>Start active</td> </tr> <tr> <td>qIModule_1_K1</td> <td></td> <td>K1</td> <td>%M14.6</td> <td>BOOL</td> <td></td> <td></td> <td>Relay K1 activated</td> </tr> <tr> <td>qIModule_1_K2</td> <td></td> <td>K2</td> <td>%M14.7</td> <td>BOOL</td> <td></td> <td></td> <td>Relay K2 activated</td> </tr> <tr> <td>qIModule_1_S1</td> <td></td> <td>S1</td> <td>%M15.0</td> <td>BOOL</td> <td></td> <td></td> <td>S1 active</td> </tr> <tr> <td>qIModule_1_S2</td> <td></td> <td>S2</td> <td>%M15.1</td> <td>BOOL</td> <td></td> <td></td> <td>S2 active</td> </tr> <tr> <td>qIModule_1_S3</td> <td></td> <td>S3</td> <td>%M15.2</td> <td>BOOL</td> <td></td> <td></td> <td>S3 active</td> </tr> <tr> <td>qIModule_1_S4</td> <td></td> <td>S4</td> <td>%M15.3</td> <td>BOOL</td> <td></td> <td></td> <td>S4 active</td> </tr> <tr> <td>qIModule_1_WaitingForStart</td> <td></td> <td>WaitingFo...</td> <td>%M15.4</td> <td>BOOL</td> <td></td> <td></td> <td>Waiting for start condition</td> </tr> <tr> <td>qIModule_1_SyncFailure</td> <td></td> <td>SyncFailure</td> <td>%M15.5</td> <td>BOOL</td> <td></td> <td></td> <td>Synchronicity failure. Reoperate S2 and S3.</td> </tr> <tr> <td colspan="8">Outputs</td> </tr> <tr> <td>qO0</td> <td></td> <td>O00</td> <td>%O03</td> <td>BYTE</td> <td></td> <td></td> <td></td> </tr> <tr> <td>qIModule_1_Enable</td> <td></td> <td>Enable</td> <td>%Q13.0</td> <td>BOOL</td> <td></td> <td></td> <td>Activation of Safety outputs enabled</td> </tr> <tr> <td>qIModule_1_ResetModule</td> <td></td> <td>ResetMod...</td> <td>%Q13.1</td> <td>BOOL</td> <td></td> <td></td> <td>Deactivate module (current source switched off)</td> </tr> <tr> <td>qIModule_1_KeepAlive</td> <td></td> <td>KeepAlive</td> <td>%Q13.2</td> <td>BOOL</td> <td></td> <td></td> <td>Safety function delays active even when bus is 'dead' (timeout)</td> </tr> <tr> <td>qIModule_1_SyncOn</td> <td></td> <td>SyncOn</td> <td>%Q13.3</td> <td>BOOL</td> <td></td> <td></td> <td>Synchronization time monitoring active</td> </tr> </tbody> </table>	Variable	Mapping	Channel	Address	Type	D...	Link	Description	Diagnostics								I20		I20	%I20.0	WORD				qIModule_1_OutputOn		OutputOn	%M14.0	BOOL			Safety output on	qIModule_1_Supply		Supply	%M14.1	BOOL			Supply available (AIJ2)	qIModule_1_SupplyFail		SupplyFail	%M14.2	BOOL			Supply out of tolerance	qIModule_1_CH1		CH1	%M14.3	BOOL			Channel 1 active	qIModule_1_CH2		CH2	%M14.4	BOOL			Channel 2 active	qIModule_1_Start		Start	%M14.5	BOOL			Start active	qIModule_1_K1		K1	%M14.6	BOOL			Relay K1 activated	qIModule_1_K2		K2	%M14.7	BOOL			Relay K2 activated	qIModule_1_S1		S1	%M15.0	BOOL			S1 active	qIModule_1_S2		S2	%M15.1	BOOL			S2 active	qIModule_1_S3		S3	%M15.2	BOOL			S3 active	qIModule_1_S4		S4	%M15.3	BOOL			S4 active	qIModule_1_WaitingForStart		WaitingFo...	%M15.4	BOOL			Waiting for start condition	qIModule_1_SyncFailure		SyncFailure	%M15.5	BOOL			Synchronicity failure. Reoperate S2 and S3.	Outputs								qO0		O00	%O03	BYTE				qIModule_1_Enable		Enable	%Q13.0	BOOL			Activation of Safety outputs enabled	qIModule_1_ResetModule		ResetMod...	%Q13.1	BOOL			Deactivate module (current source switched off)	qIModule_1_KeepAlive		KeepAlive	%Q13.2	BOOL			Safety function delays active even when bus is 'dead' (timeout)	qIModule_1_SyncOn		SyncOn	%Q13.3	BOOL			Synchronization time monitoring active
Variable	Mapping	Channel	Address	Type	D...	Link	Description																																																																																																																																																																																		
Diagnostics																																																																																																																																																																																									
I20		I20	%I20.0	WORD																																																																																																																																																																																					
qIModule_1_OutputOn		OutputOn	%M14.0	BOOL			Safety output on																																																																																																																																																																																		
qIModule_1_Supply		Supply	%M14.1	BOOL			Supply available (AIJ2)																																																																																																																																																																																		
qIModule_1_SupplyFail		SupplyFail	%M14.2	BOOL			Supply out of tolerance																																																																																																																																																																																		
qIModule_1_CH1		CH1	%M14.3	BOOL			Channel 1 active																																																																																																																																																																																		
qIModule_1_CH2		CH2	%M14.4	BOOL			Channel 2 active																																																																																																																																																																																		
qIModule_1_Start		Start	%M14.5	BOOL			Start active																																																																																																																																																																																		
qIModule_1_K1		K1	%M14.6	BOOL			Relay K1 activated																																																																																																																																																																																		
qIModule_1_K2		K2	%M14.7	BOOL			Relay K2 activated																																																																																																																																																																																		
qIModule_1_S1		S1	%M15.0	BOOL			S1 active																																																																																																																																																																																		
qIModule_1_S2		S2	%M15.1	BOOL			S2 active																																																																																																																																																																																		
qIModule_1_S3		S3	%M15.2	BOOL			S3 active																																																																																																																																																																																		
qIModule_1_S4		S4	%M15.3	BOOL			S4 active																																																																																																																																																																																		
qIModule_1_WaitingForStart		WaitingFo...	%M15.4	BOOL			Waiting for start condition																																																																																																																																																																																		
qIModule_1_SyncFailure		SyncFailure	%M15.5	BOOL			Synchronicity failure. Reoperate S2 and S3.																																																																																																																																																																																		
Outputs																																																																																																																																																																																									
qO0		O00	%O03	BYTE																																																																																																																																																																																					
qIModule_1_Enable		Enable	%Q13.0	BOOL			Activation of Safety outputs enabled																																																																																																																																																																																		
qIModule_1_ResetModule		ResetMod...	%Q13.1	BOOL			Deactivate module (current source switched off)																																																																																																																																																																																		
qIModule_1_KeepAlive		KeepAlive	%Q13.2	BOOL			Safety function delays active even when bus is 'dead' (timeout)																																																																																																																																																																																		
qIModule_1_SyncOn		SyncOn	%Q13.3	BOOL			Synchronization time monitoring active																																																																																																																																																																																		
<p>Distributed TM7 I/O device</p>	 <table border="1" data-bbox="617 933 1179 1161"> <thead> <tr> <th>Variable</th> <th>Mapping</th> <th>Channel</th> <th>Address</th> <th>Type</th> <th>Default Value</th> <th>Link</th> <th>Description</th> </tr> </thead> <tbody> <tr> <td>ConvIt10_0801</td> <td></td> <td>TM7COM168(1) OUT DigitalOutput00...</td> <td>DigitalOutput15</td> <td>%Q13</td> <td>USBIT</td> <td></td> <td></td> </tr> <tr> <td>ConvIt10_1801</td> <td></td> <td>TM7COM168(1) IN DigitalInput00...</td> <td>DigitalInput07</td> <td>%I36</td> <td>USBIT</td> <td></td> <td></td> </tr> </tbody> </table>	Variable	Mapping	Channel	Address	Type	Default Value	Link	Description	ConvIt10_0801		TM7COM168(1) OUT DigitalOutput00...	DigitalOutput15	%Q13	USBIT			ConvIt10_1801		TM7COM168(1) IN DigitalInput00...	DigitalInput07	%I36	USBIT																																																																																																																																																																		
Variable	Mapping	Channel	Address	Type	Default Value	Link	Description																																																																																																																																																																																		
ConvIt10_0801		TM7COM168(1) OUT DigitalOutput00...	DigitalOutput15	%Q13	USBIT																																																																																																																																																																																				
ConvIt10_1801		TM7COM168(1) IN DigitalInput00...	DigitalInput07	%I36	USBIT																																																																																																																																																																																				

Magelis HMI XBTGT6340

Overview

This application uses a Magelis HMI XBTGT6340. This HMI device communicates with the logic controller using the SoMachine protocol on Ethernet. The HMI is programmed using the software tool Vijeo-Designer.

Home Screen

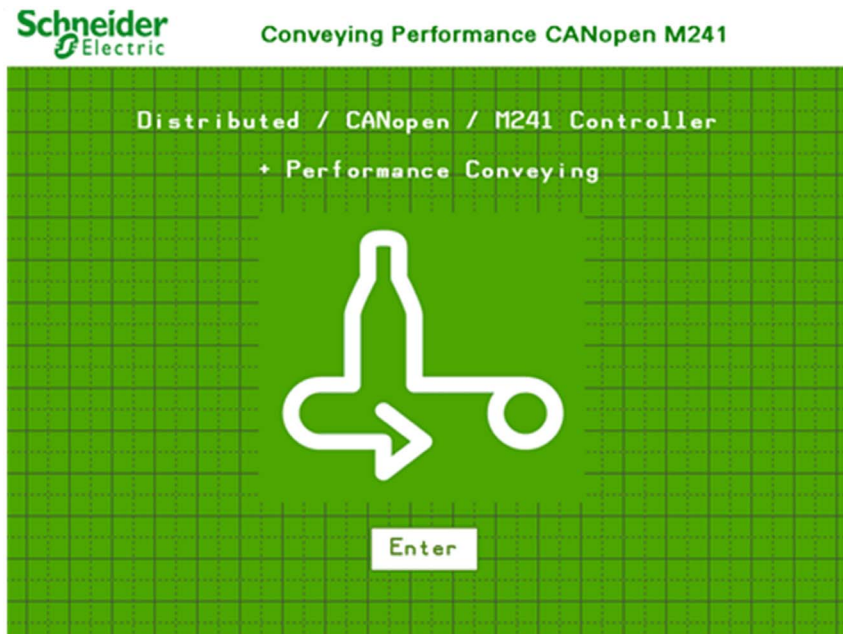

This is the **Home** screen during edit mode. This screen appears when the logic controller is connected to the HMI.

Conveyor Overview

On the display, the **Overview** screen presents several different conveying animation elements during RUNNING mode.

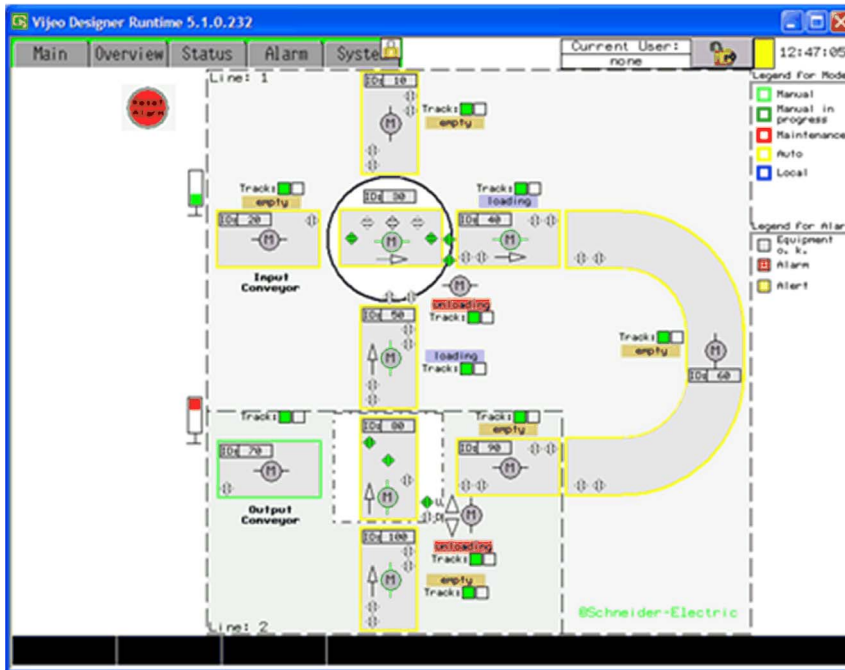

The table below describes the different types of conveyor:

Conveyor Type	Description
<p>ERC:</p>	<ol style="list-style-type: none"> 1. The ERC is in 90°/270° position. 2. The conveyor unit is in automatic mode (yellow frame). 3. The motor is running (green motor symbol). 4. The direction sign is set in reverse direction (white arrow sign). 5. The up-position sensor is in detection mode. 6. The ERC is unloading (text message). 7. The status of the tracking information is OK (green light).

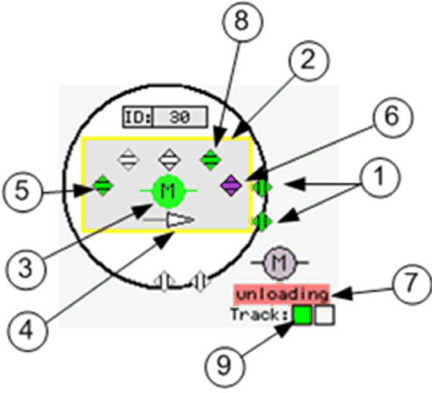
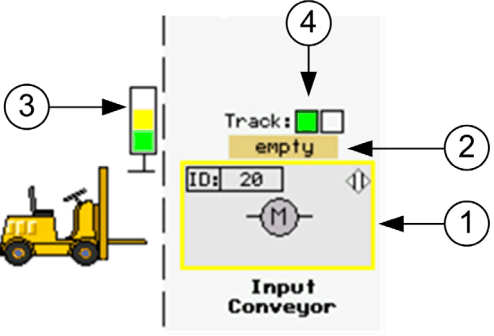
Conveyor Type	Description
<p>Turntable Example 1:</p> 	<ol style="list-style-type: none"> 1. The Turntable is in 180°/360° position, and the sensor position and speed sensor change for 180°/360° are set (green). 2. The conveyor unit is in automatic mode (yellow frame). 3. The motor is running (green motor symbol). 4. The direction sign is set in forward direction (white arrow sign). 5. The position of left interlock sensor does not detect a pallet (no interlock: green). 6. The position of right interlock sensor does not detect a pallet (purple). 7. The turntable is in unloading state (text message). 8. The forward pallet position sensor (B1) detects a pallet. 9. The status of the tracking information is OK (green light).
<p>Turntable Example 2:</p> 	<ol style="list-style-type: none"> 1. The turntable position is moving from 180°/360° to 90°/270° and position sensor and speed sensor are set (white). 2. The turntable is in empty state (text message) 3. The motor for the turn of the turntable is running (green motor symbol). 4. The status of the tracking information is OK (green light).

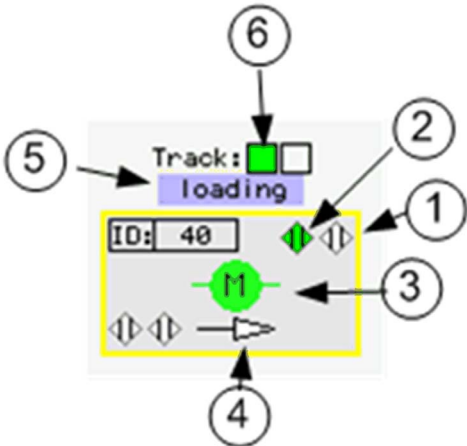
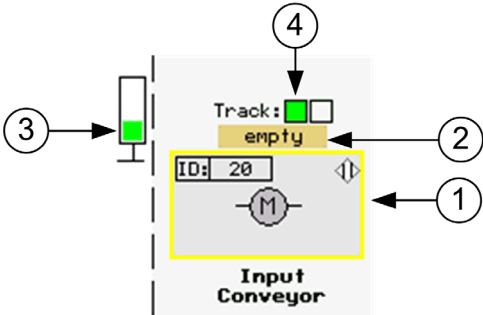
Conveyor Type	Description
<p>Standard conveyor:</p> 	<ol style="list-style-type: none"> 1. The conveyor unit is in automatic mode (yellow frame). 2. The forward speed change sensor (B3) detects a pallet. 3. The motor is running (green motor symbol). 4. The direction sign is set in forward direction (white arrow sign). 5. The turntable is in loading state (text message). 6. The status of the tracking information is OK (green light).
<p>Input conveyor Example 1:</p> 	<ol style="list-style-type: none"> 1. The conveyor unit is in automatic mode (yellow frame). 2. The turntable is in empty state (text message). 3. The input is ready for loading (green sign for the forklift). 4. The status of the tracking information is OK (green light).

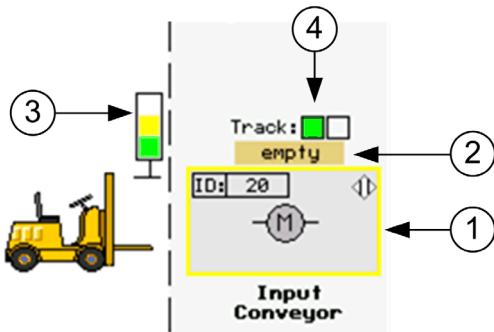
Conveyor Type	Description
<p>Input conveyor Example 2:</p> 	<ol style="list-style-type: none"> 1. The conveyor unit is in automatic mode (yellow frame). 2. The turntable is in empty state (text message). 3. A forklift is detected with the help of an inductive loop. The <code>Conveyor</code> application function block set the yellow light for forklift detection and a green light for ready to load. 4. The status of the tracking information is OK (green light).

Software Elements

The following table describes different types of panels and windows in Vijeo-Designer:

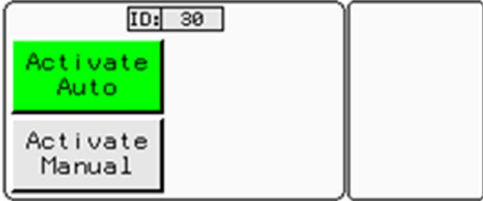
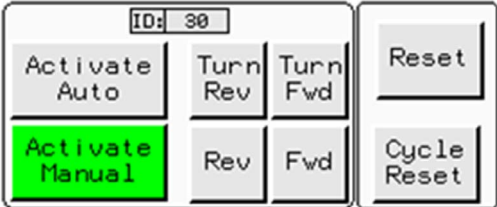
Element	Description
<p>Command panel in automatic mode:</p> 	<p>It allows you to change the mode of the equipment (auto/manual). ID: 30 -> conveyor identifier 30</p>
<p>Command panel in manual mode:</p> 	<p>This example presents the manual command panel for a turntable.</p>

Element	Description																																														
<p>Status window:</p> <table border="1" data-bbox="152 232 686 350"> <tr> <td>Line:</td> <td>101</td> <td>ID:</td> <td>80</td> </tr> <tr> <td>Type:</td> <td colspan="3">Erc equipped with Conv_2S2D (4Sensors)</td> </tr> <tr> <td>Operating hours:</td> <td>Drive 1: 0</td> <td>Drive 2: 0</td> <td>Drive 3: 0</td> </tr> <tr> <td>Alarm-Status:</td> <td>0</td> <td>0</td> <td>0</td> </tr> <tr> <td>Alert-Status:</td> <td>0</td> <td>0</td> <td>0</td> </tr> <tr> <td>State-Machine:</td> <td colspan="3">unloading</td> </tr> </table> <p data-bbox="152 350 686 399"> Tracking ErcIni Close </p>	Line:	101	ID:	80	Type:	Erc equipped with Conv_2S2D (4Sensors)			Operating hours:	Drive 1: 0	Drive 2: 0	Drive 3: 0	Alarm-Status:	0	0	0	Alert-Status:	0	0	0	State-Machine:	unloading			<p>This window gives an overview of the equipment status:</p> <ul style="list-style-type: none"> ● Touch Tracking to open the tracking information for this conveyor unit. You may read and modify the information. ● Touch ErcIni to open the initialization window for the ERC unit. This window gives information about the initialization data of the ERC and allows you to modify the values. 																						
Line:	101	ID:	80																																												
Type:	Erc equipped with Conv_2S2D (4Sensors)																																														
Operating hours:	Drive 1: 0	Drive 2: 0	Drive 3: 0																																												
Alarm-Status:	0	0	0																																												
Alert-Status:	0	0	0																																												
State-Machine:	unloading																																														
<p>ERC window:</p> <div data-bbox="152 480 686 880"> <table border="1"> <thead> <tr> <th colspan="2">Equipment</th> <th></th> <th colspan="2">Clipboard</th> </tr> </thead> <tbody> <tr><td>1</td><td>o</td><td rowspan="10"> Read from select unit Cut select unit Write to select unit Delete select unit </td><td>1</td><td>o</td></tr> <tr><td>2</td><td>o</td><td>2</td><td>o</td></tr> <tr><td>3</td><td>o</td><td>3</td><td>o</td></tr> <tr><td>4</td><td>o</td><td>4</td><td>o</td></tr> <tr><td>5</td><td>o</td><td>5</td><td>o</td></tr> <tr><td>6</td><td>o</td><td>6</td><td>o</td></tr> <tr><td>7</td><td>o</td><td>7</td><td>o</td></tr> <tr><td>8</td><td>o</td><td>8</td><td>o</td></tr> <tr><td>9</td><td>o</td><td>9</td><td>o</td></tr> <tr><td>10</td><td>o</td><td>10</td><td>o</td></tr> </tbody> </table> <p data-bbox="196 760 257 776">Track: <input type="checkbox"/></p> <p data-bbox="375 716 465 740">Close</p> <p data-bbox="543 740 636 756">Destination</p> <p data-bbox="543 797 636 880"> 270 180 360 90 </p> </div>	Equipment			Clipboard		1	o	Read from select unit Cut select unit Write to select unit Delete select unit	1	o	2	o	2	o	3	o	3	o	4	o	4	o	5	o	5	o	6	o	6	o	7	o	7	o	8	o	8	o	9	o	9	o	10	o	10	o	<p>The tracking window of the ERC allows the following functions:</p> <ul style="list-style-type: none"> ● Read the tracking information from a clipboard memory ● Cut the tracking information ● Write the tracking information to the equipment tracking field ● Delete the tracking information into the equipment tracking field <p>Use a Destination button 360, 90,180 and 270 to modify the destination of a box or pallet.</p>
Equipment			Clipboard																																												
1	o	Read from select unit Cut select unit Write to select unit Delete select unit	1	o																																											
2	o		2	o																																											
3	o		3	o																																											
4	o		4	o																																											
5	o		5	o																																											
6	o		6	o																																											
7	o		7	o																																											
8	o		8	o																																											
9	o		9	o																																											
10	o		10	o																																											

Element	Description																																				
<p>Equipment Initialization window:</p> <div style="border: 1px solid black; padding: 10px;"> <p style="text-align: center;">ErcIni</p> <table border="1" style="width: 100%; border-collapse: collapse;"> <tr> <td style="width: 15%;">sLoadCtrl</td> <td>xLdngHrmDsbl</td> <td>False</td> <td>False</td> </tr> <tr> <td>sUnidCtrl</td> <td>tLoadCtrlFwd</td> <td>120000</td> <td>120000</td> </tr> <tr> <td></td> <td>tLoadCtrlRev</td> <td>120000</td> <td>120000</td> </tr> <tr> <td>sErcTab1Stn</td> <td>tDlytoSpdChgFwd</td> <td>0</td> <td>0</td> </tr> <tr> <td></td> <td>tDlytoSpdChgRev</td> <td>0</td> <td>0</td> </tr> <tr> <td>sMotCtrl</td> <td>tNotDlytoStopFwd</td> <td>0</td> <td>0</td> </tr> <tr> <td></td> <td>tNotDlytoStopRev</td> <td>0</td> <td>0</td> </tr> <tr> <td>sVer1NovCtrl</td> <td>tStagFnsHCtrl_Load</td> <td>100</td> <td>100</td> </tr> <tr> <td></td> <td>tStagFnsHCtrl_Unload</td> <td>100</td> <td>100</td> </tr> </table> <p style="text-align: center; margin-top: 20px;">t(time) in ms</p> <div style="display: flex; justify-content: space-around; margin-top: 20px;"> <div style="border: 1px solid black; padding: 5px; background-color: #cccccc;">Execute Init.</div> <div style="border: 1px solid black; padding: 5px; background-color: #cccccc;">Close</div> </div> </div>	sLoadCtrl	xLdngHrmDsbl	False	False	sUnidCtrl	tLoadCtrlFwd	120000	120000		tLoadCtrlRev	120000	120000	sErcTab1Stn	tDlytoSpdChgFwd	0	0		tDlytoSpdChgRev	0	0	sMotCtrl	tNotDlytoStopFwd	0	0		tNotDlytoStopRev	0	0	sVer1NovCtrl	tStagFnsHCtrl_Load	100	100		tStagFnsHCtrl_Unload	100	100	<p>This window displays the values of different parameters (present values and setpoint values). The setpoint values are editable. Touch the Execute Init. button to validate the modified values.</p>
sLoadCtrl	xLdngHrmDsbl	False	False																																		
sUnidCtrl	tLoadCtrlFwd	120000	120000																																		
	tLoadCtrlRev	120000	120000																																		
sErcTab1Stn	tDlytoSpdChgFwd	0	0																																		
	tDlytoSpdChgRev	0	0																																		
sMotCtrl	tNotDlytoStopFwd	0	0																																		
	tNotDlytoStopRev	0	0																																		
sVer1NovCtrl	tStagFnsHCtrl_Load	100	100																																		
	tStagFnsHCtrl_Unload	100	100																																		