

# Product Data Sheet

## DX52125

FK Range

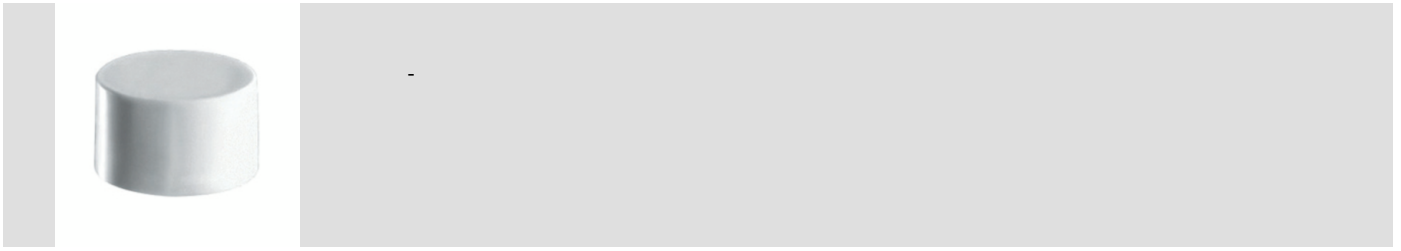

Colour	Grey RAL 7035	Material	PP
Conduits Ø (mm)	25	Electrocod	210

### DIMENSIONAL

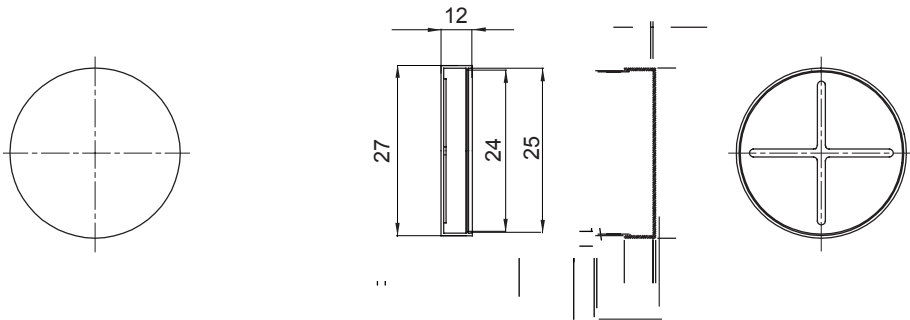

### STANDARDS/APPROVALS

