

PRODUCT DATASHEET

HB V 120W 865 90DEG IP66

HIGH BAY V | HIGH BAY luminaires with up to 185lm/w efficiency and long lifespan



VALUE
CLASS

Areas of application

- Replacement for high bay luminaires with mercury vapor or metal halide lamps
- Warehouses, logistic halls
- Industry
- High ceiling (e.g. in shopping malls, airports, commercial buildings, lobbies)

Product benefits

- Low flicker light thanks to special electronic control gear
- Energy savings thanks to system efficacy up to 185lm/W
- Low product weight to optimize installation
- Modern and robust design
- 5 years guarantee

Product features

- Lifetime (L70/B50): up to 100,000 h (at 35 °C)
- Operating temperature up to 50 degree Celsius
- Different luminous flux and beam angle for mounting heights of ~ 6 m to 18 m
- Available in 4000K, 5700K and 6500K
- Type of protection: IP66
- Impact resistance: IK10

TECHNICAL DATA

Electrical data

Nominal wattage	120.00 W
Nominal voltage	220...240 V
Mains frequency	50...60 Hz
Nominal current	590.000 mA
Inrush current	40 A
Inrush current time T_{h50}	600 μ s
Max. number of luminaires per miniature circuit breaker B16	5
Max. number of luminaires per miniature circuit breaker C10	3
Max. number of luminaires per miniature circuit breaker C16	6
Power factor λ	≥ 0.95
Total harmonic distortion	< 20 %
Protection class	I
Operating mode	Integrated LED driver

Photometrical data

Luminous flux	21600 lm
Luminous efficacy	180 lm/W
Color temperature	6500 K
Light color (designation)	Cool Daylight
Color rendering index Ra	80
Standard deviation of color matching	5 sdc
Photobiological safety group acc. to EN62778	RG1
Beam angle	90 °

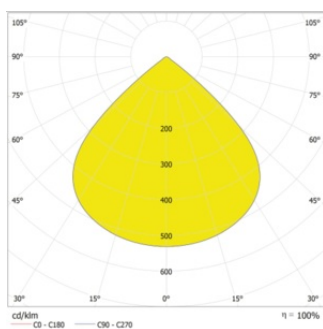

HB V 90DEG

Dimensions & Weight

Diameter	246.00 mm
Height	120.00 mm
Product weight	1100.00 g

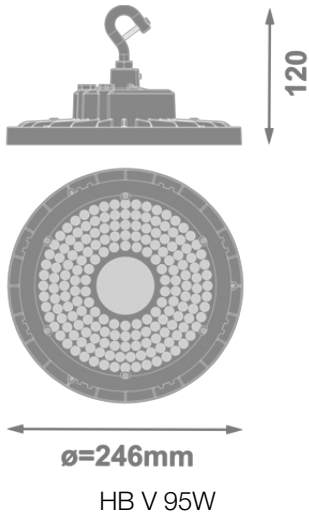

Materials & Colors

Product color	Black
Housing color	Black
Body material	Aluminum
Cover material	Polycarbonate (PC)
Glow Wire Test according to IEC 60695-2-12	650 °C
Mercury content	0.0 mg

Application & Mounting

Ambient temperature range	-20...+50 °C
Temperature range at storage	-40...+70 °C
Type of connection	Cable, 3-pole
Type of protection	IP66
Protection class IK (shock resistance)	IK10
Dimmable	No
Mounting type	Suspended/Surface
Application environment	Indoor
With light source	Yes

Lifespan

Lifespan L70/B50 at 25 °C	100000 h ¹⁾
---------------------------	------------------------

Lifespan L80/B10 at 25 °C	96000 h ¹⁾
Lifespan L80/B50 at 25 °C	96000 h
Lifespan L90/B10 at 25 °C	49000 h
Number of switching cycles	100000

1) t[h]: L70 / B50 @ 25 °C (Ta), t[h]: L80 / B10 @ 25 °C (Ta), t[h]: L90 / B10 @ 25 °C (Ta)







Control gear

ECG - Output ripple current	< 10 %
-----------------------------	--------

Certificates & Standards

Standards	CE / ROHS / REACH / ENEC / ERP
Luminaire with limited surface temperature, "D sign"	Yes
Ball shot safe	No
Replaceable light source (EPREL)	Not replaceable

DOWNLOAD DATA

Documents and certificates		Document name
	User instruction / safety instructions	HB V IP66
	Legal information	HB V IP66
	Legal information	HB V IP66
	Legal information	Informationstext 18 Abs 4 ElektroG
	Declarations of conformity	HB V IP66
Photometric and lighting design files		Document name
	Light distribution curve type polar	HB V 90DEG

LOGISTICAL DATA

Product code	Packaging unit (Pieces/Unit)	Dimensions (length x width x height)	Gross weight	Volume
4099854326493	Shipping box 1	300 mm x 300 mm x 125 mm	1756.00 g	11.25 dm ³

The mentioned product code describes the smallest quantity unit which can be ordered. One shipping unit can contain one or more single products. When placing an order, for the quantity please enter single or multiples of a shipping unit.

DISCLAIMER

Subject to change without notice. Errors and omission excepted. Always make sure to use the most recent release.