

## Introduction



The RFID safety sensors of the ST G - ST H series represent the evolution of the ST D series already known and appreciated by machine builders and users.

The symmetry of the housing allows the same sensor to be used on both left and right doors; by simply rotating the sensor onto itself. The mounting hole spacing (22 mm for the ST G series, 78 mm for the ST H series) was especially realised to perform a technological upgrade of the traditional magnetic sensors of the SR A and SR B series, replacing these with an evolved RFID safety sensor, without changing the machine's mounting hole spacing.

The monolithic housing – free of resins for encapsulation – can be used in even the most aggressive of environments; such as, for example, in the food and pharmaceuticals sector.

## Maximum safety with a single device

# PL e + SIL 3

The sensors of the ST G - ST H series are constructed with redundant electronics. As a result, the maximum PL e and SIL 3 safety levels can still be achieved through the use of a single device on a guard. This avoids expensive wiring in the field and allows faster installation. Inside the control cabinet, the two electronic safety outputs must be connected to a safety module with OSSD inputs or to a safety PLC.

## High level coded actuators



The sensors are provided with an electronic system based on RFID technology to detect the actuator. This allows to provide each actuator with different coding and makes it impossible to tamper with a device by using another actuator of the same series. Millions of different coding combinations are possible for the actuators. They are therefore classified as high level coded actuators, according to EN ISO 14119.

## Series connection of multiple sensors

One of the most important features of the ST G - ST H series from Pizzato Elettrica is the possibility of connecting up to 32 sensors in series, while still maintaining the maximum safety level (PL e) laid down in EN 13849-1.

This connection type is permissible in safety systems which have a safety module at the end of the chain that monitors the outputs of the last sensor.

The fact that the PL e safety level can be maintained even with 32 sensors connected in series demonstrates the extremely secure structure of each sensor of this series.

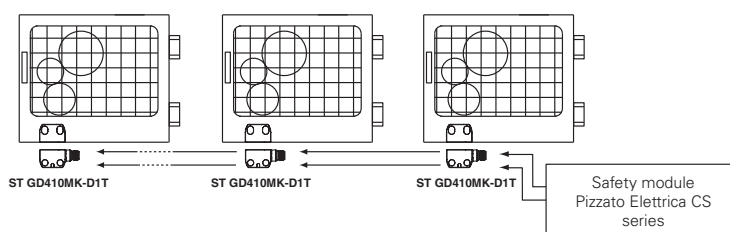

## Series connection with other devices

The ST G - ST H series features two safety inputs and two safety outputs, which can be connected in series with other Pizzato Elettrica safety devices. This option allows the creation of safety chains containing various devices. For example, stainless steel hinge switches (HX BEE1 series), RFID sensors (ST series) and guard-locking switches (NG or NS series) can be connected in series while still maintaining the maximum PL e and SIL 3 safety levels.

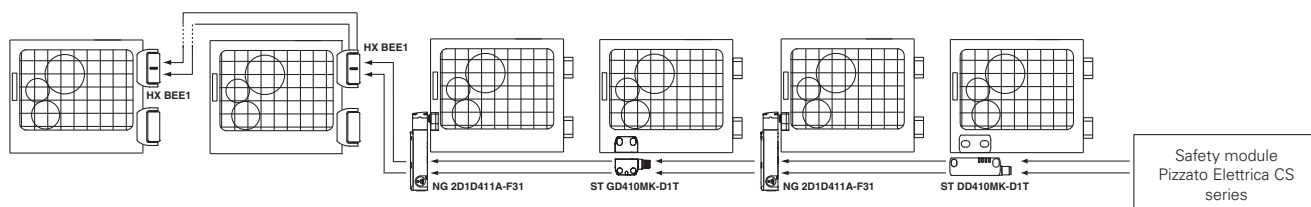

## Protection against tampering

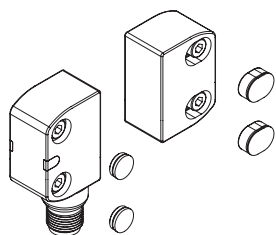

Each sensor and actuator is supplied complete with snap-on protection caps to be applied on the holes of the fixing screws. Not only do the caps prevent dirt from accumulating and simplify cleaning, they also block access to the fastening screws of the actuator. As a result, standard screws can be used instead of tamper-proof screws.

## Protection degrees IP67 and IP69K

# IP69K IP67

These devices are designed to be used under the toughest environmental conditions, and they pass the IP67 immersion test acc. to EN 60529. They can therefore be used in all environments where the maximum degree of protection is required for the housing. Due to their special design, these devices are suitable for use in equipment subjected to cleaning with high pressure hot water jets. These devices meet the IP69K test requirements according to ISO 20653 (water jets with 100 bar and 80°C).

## Actuation from many directions

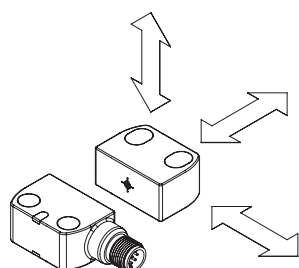

The sensors were designed to be activated from various directions, thereby providing the customer with maximum flexibility when positioning the sensors on the guards.

## Laser engraving

All devices are marked using a dedicated indelible laser system. These engravings are therefore suitable for extreme environments too. Thanks to this system that does not use labels, the loss of plate data is prevented and a greater resistance of the marking is achieved over time.





### Symmetrical housing

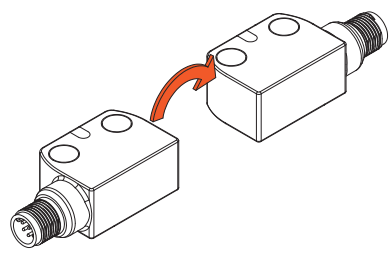

Both sensor and actuator are perfectly symmetrical, and can therefore be attached to the machine frame in any orientation.

This feature allows the user to decide the side on which the cable or connector should exit, according to the sensor mounting position, by simply rotating it into the desired direction; thus eliminating the need to order differently coded products.

### Multicolour signalling LED



The ST G - ST H series sensors have a multicolour RGB signalling LED, which, using suitable transparent lenses, can be seen from both sides of the device. This allows fast, immediate diagnostics of the input and output operating states.

This makes it possible to quickly identify the interruption points in the safety chain, active devices, open guards, and any internal device errors – all of which can be identified simply and intuitively.

### Insensitivity to dirt and protection of the cable

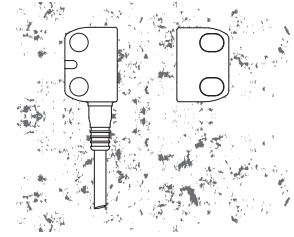

The sensors are completely sealed and retain their safety characteristics even in the presence of dirt or deposits (not ferromagnetic material). This characteristic, combined with the design without recesses, makes them particularly suitable for use in the food industry. In the versions with cable, this is protected with a gasket located near the output of the switch.

This gasket is also provided with knurling by means of which a corrugated tube can be fastened as cable protection.

### Special multitag versions

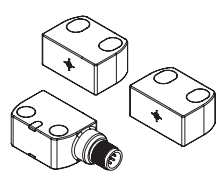

Special versions of the device are available that have two or more actuators with a high level of coding, all of which can be recognised by the same sensor. The internal firmware of the sensor can be factory programmed, memorising a different device behaviour for each actuator when the actuator is in front of the sensor.

The multitag function is particularly useful in machines with several work stations, that require various operating modes on the basis of the actuator recognised by the sensor (e.g.: interchangeable machine parts, position of robot, rotary tables, etc.)

### Magnetic holding of the actuator

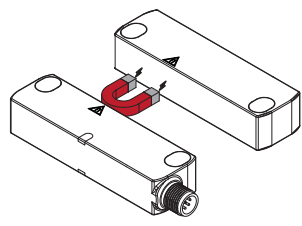

Devices of the ST H series can be ordered with a permanent magnet installed inside the housing, able to generate a holding force between sensor and actuator.

This way, the guard can be kept closed even when there are vibrations or when there is a recoil during the closing stage.

The magnetic holding force can be selected in three different magnitudes to best adapt to any usage situation.

### External device monitoring

**EDM** On request, the switch can be supplied with EDM function (External Device Monitoring). In this case, the switch itself checks the proper function of the devices connected to the safety outputs. These devices (usually relays or safety contactors) must send a feedback signal to the EDM input, which checks that the received signal is consistent with the state of the safety outputs.

### Programmability

Programmable sensor versions are available. Here, with a simple and brief operation, the sensor can be programmed to recognise the code of a new actuator.

By activating a special input, the sensor is switched to a safe state, during which it waits for a new code to be accepted. As the actuator approaches, the sensor performs a number of checks on the code being received, whereby the code must adhere to certain parameters of RFID technology.

If the checks are successful, the sensor uses LEDs to signal the successful completion of the procedure.

After programming has been completed, the sensor only recognises the code of the last programmed actuator, thereby preserving the safety level and the reliability of the system in which it is installed.

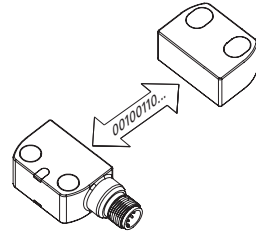

### Versions for mobile applications

# 10-30V

The RFID safety sensors of the ST H series are now also available in the version with 10-30 V supply voltage, designed for mobile applications where a supply voltage of 12 V is usually available, but also for situations in which the supply voltage is far from the 24 V commonly available in industrial environments.

### Extended temperature

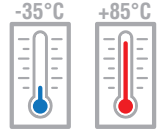

Devices with a T8 code extension can be installed in environments with temperatures from -35°C to +85°C and are especially indicated for machines in the food and pharmaceutical sector, allowing to use ST sensors in a broad field of application.

The extended temperature versions are available for both articles with a cable, and those with a stainless steel connector.

### Compatible with all SM ••T actuators

Designed for use in conjunction with the SM G•T and SM H•T series actuators, together they form a complete assembly, even from an aesthetic point of view; the ST G and ST H sensors are also compatible with all actuators available for the ST series, with either high or low level of coding.

This is particularly useful in applications where the actuator must have specific characteristics; such as, for example, increased activation distance (SM E•T actuators), compact installation dimensions (SM L•T actuators), or fixing holes positioned on two different sides (SM D•T).

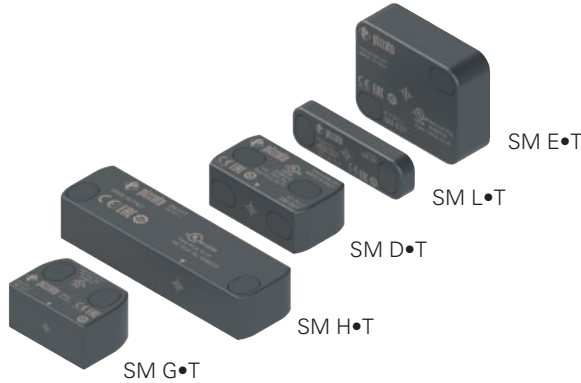

Selection diagram

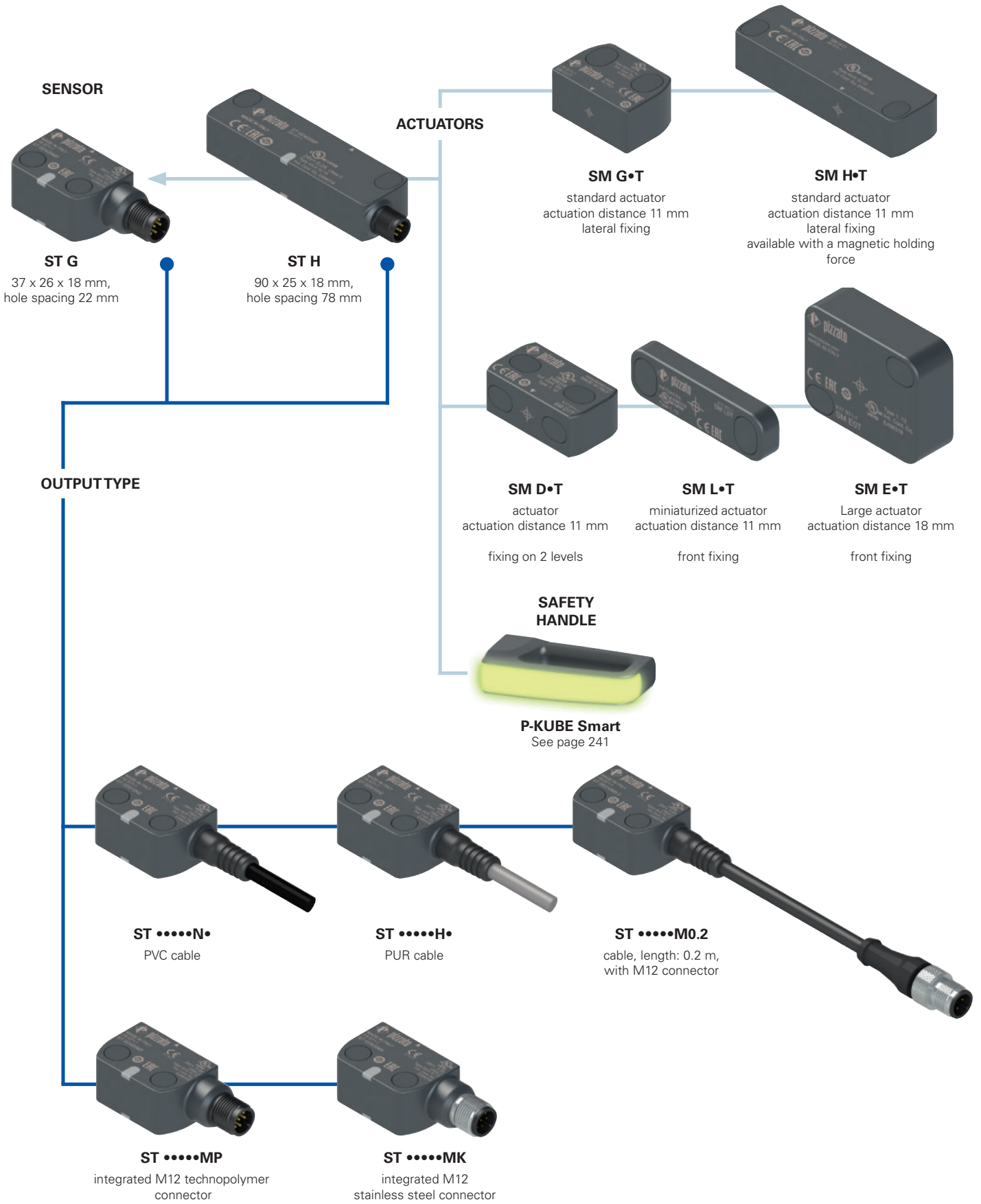

- product option
- Sold separately as accessory





### Main features

- Actuation without contact, using RFID technology
- Digitally coded actuator
- Protection degrees IP67 and IP69K
- Symmetrical housing with universal fixing orientation
- Multicolour signalling LED
- Versions with extended temperature range from -35 °C to +85 °C
- Multitag versions with two or more actuators
- ST H versions available with a magnetic holding force of the actuator
- ST H versions with extended supply voltage range 10 ... 30 Vdc

### Quality marks:



UL approval: E496318  
 EC type examination certificate: M6A 075157 0027  
 TÜV SÜD approval: Z10 075157 0026  
 EAC approval: RU C-IT.YT03.B.00035/19  
 ECOLAB approval: 0111/19 + 0096/20

### In compliance with standards:

IEC 61508-1, IEC 61508-2, IEC 61508-3, IEC 61508-4, EN ISO 13849-1, EN ISO 13849-2, EN ISO 14119, EN 62061, EN 60947-5-3, EN 60947-5-2, EN 60947-1, EN 61326-1, EN 61326-3-1, EN 61326-3-2, EN IEC 63000, ETSI 301 489-1, ETSI 301 489-3, ETSI 300 330, UL 508, CSA C22.2 No. 14.

### Compliance with the requirements of:

Machinery Directive 2006/42/EC,  
 EMC Directive 2014/30/EC,  
 Directive 2014/53/EU - RED,  
 RoHS Directive 2011/65/EU,  
 FCC Part 15.

### Connection with safety modules for safety applications:

Connection with safety modules  
 CS AR-01•••••; CS AR-02•••••; CS AR-05•••••;  
 CS AR-06•••••; CS AR-08•••••; CS AT-0•••••;  
 CS AT-1•••••; CS MP•••••.

When connected to the safety module, the sensor can be classified as a control circuit device up to PDDb (EN 60947-5-3).

The system can be used in safety circuits up to PL e/SIL 3/category 4 in accordance with EN ISO 13849-1.

## Technical data

### Housing

Housing made of glass fibre reinforced technopolymer, self-extinguishing.  
 Versions with integrated cable 5 x 0.25 mm<sup>2</sup> or 8 x 0.25 mm<sup>2</sup>, length 2 m, other lengths on request.

Versions with integrated M12 connector, plastic or stainless steel, AISI 304.

Versions with 0.2 m cable length and M12 connector, other lengths on request.

Protection degree:

IP67 acc. to EN 60529

IP69K acc. to ISO 20653

(Protect the cables from direct high-pressure and high-temperature jets)

### General data

SIL (SIL CL) up to:

SIL 3 acc. to EN 62061

Performance Level (PL) up to:

PL e acc. to EN ISO 13849-1

Safety category up to:

cat. 4 acc. to EN ISO 13849-1

Interlock, no contact, coded:

type 4 acc. to EN ISO 14119

Level of coding acc. to EN ISO 14119:

high with SM•IT actuators

low with SM•OT actuators

Safety parameters:

MTTF<sub>D</sub>:

1551 years

PFH<sub>D</sub>:

1.19E-09

DC:

High

Mission time:

20 years

Ambient temperature for sensors without cable:

-25°C ... +70°C (standard)

-35°C ... +85°C (T8 option)

Ambient temperature for sensors with cable:

see table on page 63

Storage and transport temperature:

-35°C ... +85°C

Vibration resistance:

10 gn (10 ... 150 Hz) acc. to IEC 60068-2-6

Shock resistance:

30 gn; 11 ms acc. to EN 60068-2-27

Pollution degree

3

Screw tightening torque:

0.8 ... 1 Nm

### Power supply electrical data

Rated operating voltage U<sub>e</sub>:

24 Vdc (-15% ... +10%) SELV/PELV

10 ... 30 Vdc (version ST H•••1••)

Operating current at U<sub>e</sub> voltage:

- minimum:

20 mA

- with all outputs at maximum power:

550 mA

Rated insulation voltage U<sub>i</sub>:

32 Vdc

Rated impulse withstand voltage U<sub>imp</sub>:

1.5 kV

External protection fuse:

1 A type Gg or equivalent device

Overvoltage category:

III

### Electrical data of IS1/IS2/I3/EDM inputs

Rated operating voltage U<sub>e1</sub>:

24 Vdc

Rated current consumption I<sub>e1</sub>:

2.5 mA

Switching time EDM state (t<sub>EDM1</sub>):

500 ms

### Electrical data of OS1/OS2 safety outputs

Rated operating voltage U<sub>e2</sub>:

24 Vdc

Output type:

PNP type OSSD

Maximum current per output I<sub>e2</sub>:

0.2 A

Minimum current per output I<sub>m2</sub>:

0.5 mA

Thermal current I<sub>t2</sub>:

0.2 A

Utilization category:

DC13; U<sub>e2</sub>=24 Vdc, I<sub>e2</sub>=0.2 A

Short circuit detection:

Yes

Overcurrent protection:

Yes

Internal self-resettable protection fuse:

0.3 A

Duration of the deactivation impulses at the safety

outputs:

< 300 µs

Permissible maximum capacitance between outputs:

< 200 nF

Permissible maximum capacitance between output and ground:

< 200 nF

Response time upon deactivation of input IS1 or IS2:

< 15 ms

Response time upon actuator removal:

< 50 ms

Availability time:

2 s

### Electrical data of O3 signalling output

Rated operating voltage U<sub>e3</sub>:

24 Vdc

Output type:

PNP

Maximum current per output I<sub>e3</sub>:

0.1 A

Utilization category:

DC13; U<sub>e3</sub>=24 Vdc, I<sub>e3</sub>=0.1 A

Short circuit detection:

No

Overcurrent protection:

Yes

Internal self-resettable protection fuse:

120 mA

### Actuation data

Assured operating distance S<sub>ao</sub>:

8 mm

SM E•T actuators

14 mm

Assured release distance S<sub>ar</sub>:

20 mm

SM H•T, SM D•T, SM L•T actuators

26 mm

Rated operating distance S<sub>n</sub>:

11 mm

SM H•T actuators

18 mm

Rated release distance S<sub>nr</sub>:

13 mm

SM H•T actuators

20.5 mm

Repeat accuracy:

≤ 10 % s<sub>n</sub>

Differential travel:

≤ 20 % s<sub>n</sub>

RFID transponder frequency:

125 kHz

Max. switching frequency:

1 Hz

Distance between two sensors:

min. 50 mm





### Features approved by UL

Electrical Ratings: 24 Vdc Class 2, 0,20 A  
 Environmental Ratings: Types 1, 4X, 6, 12, 13  
 Accessory for series ST for actuator switch series SM D, SM E, SM G, SM H, SM L.  
 The models provided with M12 Connector may be provided with the mating-Connectors-part (with Cord attached).

Please contact our technical department for the list of approved products.

### Features approved by TÜV SÜD

Supply voltage: 24 Vdc -15%...+10%  
 10 - 30 Vdc (ST H•••1•• only)  
 Protection degree: IP67 and IP69K  
 Ambient temperature: -25°C ... + 70°C  
 -35°C ... + 85°C (T8 option)  
 Storage and transport temperature: -25°C ... +85°C  
 PL, category: PL e, category 4

In compliance with standards: Machinery Directive 2006/42/EC, EN ISO 13849-1:2015, EN 60947-5-3:2013, EN 61508-1:2010 (SIL 3), EN 61508-2:2010 (SIL 3), EN 61508-3:2010 (SIL 3), EN 61508-4:2010 (SIL 3), IEC 62061:2005 (SIL CL3), IEC 62061:2005/AMD1:2012, IEC 62061:2005/AMD2:2015 (SIL CL3).

Please contact our technical department for the list of approved products.

### Selection table for ST G sensors with high level coded actuators

OS safety outputs	O signalling outputs	IS safety inputs	I programming inputs	EDM inputs	Programmable	with 0.2 m cable length and M12 connector		
						with cable	with M12 connector	
2	1	-	-	-	-	ST GD210M0.2-G1T	ST GD210N•-G1T	ST GD210MP-G1T
2	1	2	-	-	-	ST GD310M0.2-G1T	ST GD310N•-G1T	ST GD310MP-G1T
2	1	2	1	-	•	ST GD420M0.2-G1T	ST GD420N•-G1T	ST GD420MP-G1T
2	1	2	-	1	-	ST GD510M0.2-G1T	ST GD510N•-G1T	ST GD510MP-G1T

### Selection table for ST H sensor with high level coded actuator

Magnetic holding force	OS safety outputs	O signalling outputs	IS safety inputs	I programming inputs	EDM inputs	Programmable	with 0.2 m cable length and M12 connector		
							with cable	with M12 connector	
-	2	1	-	-	-	-	ST HD210M0.2-H1T	ST HD210N•-H1T	ST HD210MP-H1T
	2	1	2	-	-	-	ST HD310M0.2-H1T	ST HD310N•-H1T	ST HD310MP-H1T
	2	1	2	1	-	•	ST HD420M0.2-H1T	ST HD420N•-H1T	ST HD420MP-H1T
	2	1	2	-	1	-	ST HD510M0.2-H1T	ST HD510N•-H1T	ST HD510MP-H1T
25 N	2	1	-	-	-	-	ST HE210M0.2-H1TE	ST HE210N•-H1TE	ST HE210MP-H1TE
	2	1	2	-	-	-	ST HE310M0.2-H1TE	ST HE310N•-H1TE	ST HE310MP-H1TE
	2	1	2	1	-	•	ST HE420M0.2-H1TE	ST HE420N•-H1TE	ST HE420MP-H1TE
	2	1	2	-	1	-	ST HE510M0.2-H1TE	ST HE510N•-H1TE	ST HE510MP-H1TE
40 N	2	1	-	-	-	-	ST HE210M0.2-H1TF	ST HE210N•-H1TF	ST HE210MP-H1TF
	2	1	2	-	-	-	ST HE310M0.2-H1TF	ST HE310N•-H1TF	ST HE310MP-H1TF
	2	1	2	1	-	•	ST HE420M0.2-H1TF	ST HE420N•-H1TF	ST HE420MP-H1TF
	2	1	2	-	1	-	ST HE510M0.2-H1TF	ST HE510N•-H1TF	ST HE510MP-H1TF
50 N	2	1	-	-	-	-	ST HE210M0.2-H1TG	ST HE210N•-H1TG	ST HE210MP-H1TG
	2	1	2	-	-	-	ST HE310M0.2-H1TG	ST HE310N•-H1TG	ST HE310MP-H1TG
	2	1	2	1	-	•	ST HE420M0.2-H1TG	ST HE420N•-H1TG	ST HE420MP-H1TG
	2	1	2	-	1	-	ST HE510M0.2-H1TG	ST HE510N•-H1TG	ST HE510MP-H1TG

→ The 2D and 3D files are available at [www.pizzato.com](http://www.pizzato.com)

## Selection table for sensors

OS safety outputs O signalling outputs IS safety inputs I programming inputs EDM inputs Programmable	with 0.2 m cable length and M12 connector		with cable		with M12 connector	
	ST G series	ST H series	ST G series	ST H series	ST G series	ST H series
	2	1	2	1	-	•
	ST GD420M0.2	ST HD420M0.2	ST GD420N•	ST HD420N•	ST GD420MP	ST HD420MP

## Selection table for actuators

Level of coding acc. to ISO 14119	Standard actuator	Standard actuator	Standard actuator with fixing on 2 levels	Miniaturized actuator	Large actuator
low	SM G0T	SM H0T	SM D0T	SM L0T	SM E0T
high	SM G1T	SM H1T	SM D1T	SM L1T	SM E1T

Type •0T actuators are all encoded with the same code. This implies that a sensor associated with an actuator type •0T can be activated by other actuators type •0T.

Type •1T actuators are always encoded with different codes. This implies that a sensor associated with an actuator type •1T can be activated only by a specific actuator. Another •1T type actuator will not be recognised by the sensor until a new association procedure is carried out (reprogramming). After reprogramming, the old actuator type •1T will no longer be recognized.

Reprogramming of the actuator can be performed repeatedly.

## Operating states

The multicolour signalling LED, which can be seen from both sides of the device, provides easy and intuitive verification of sensor operating state.



**GREEN LED**  
Normal operating state, with actuator inside detection zone, safety inputs activated (when present), safety outputs activated.



**YELLOW LED**  
Normal operating state, with actuator outside detection zone.



**RED LED**  
Error state: the error type is indicated to the user via LED illumination sequences and colour variations.



**PURPLE LED**  
Programming state during new actuator identification procedure.

## Internal operating wiring diagram

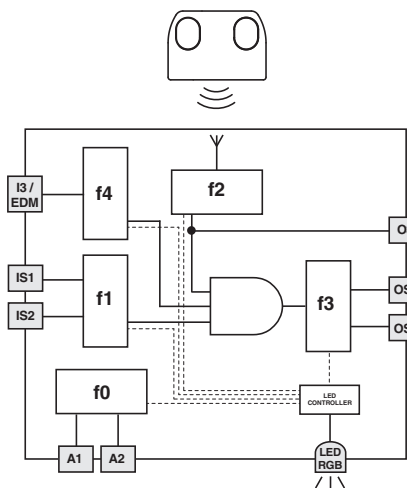

The adjacent diagram illustrates five logical, linked sub-functions of the sensor.

Function f0 is a basic function and includes the monitoring of the power supply as well as internal, cyclical tests.

Function f1 monitors the status of the inputs, whereas function f2 monitors the position of the actuator in the detection area.

Function f3 is intended to activate or deactivate the safety outputs and check for any faults or short circuits in the outputs.

The f4 function verifies the coherence of the EDM signal during safety output state changes (in versions with EDM input), or monitors the activation state of the programming input, activating the actuator replacement procedure (in versions with I3 programming input).

The safety-related function, which combines the sub-functions mentioned above, only activates the safety outputs if the input signals are correctly applied and the actuator is located within the safe zone.

The state of each function is displayed via signalling LED illumination and colour change. This immediately communicates the overall sensor state to the operator.



### Limit activation zone and safe activation zone

When aligning the sensor with the actuator, the multicolour signalling LED changes colour to indicate to the operator whether the actuator is in the limit activation zone or in the safe activation zone.

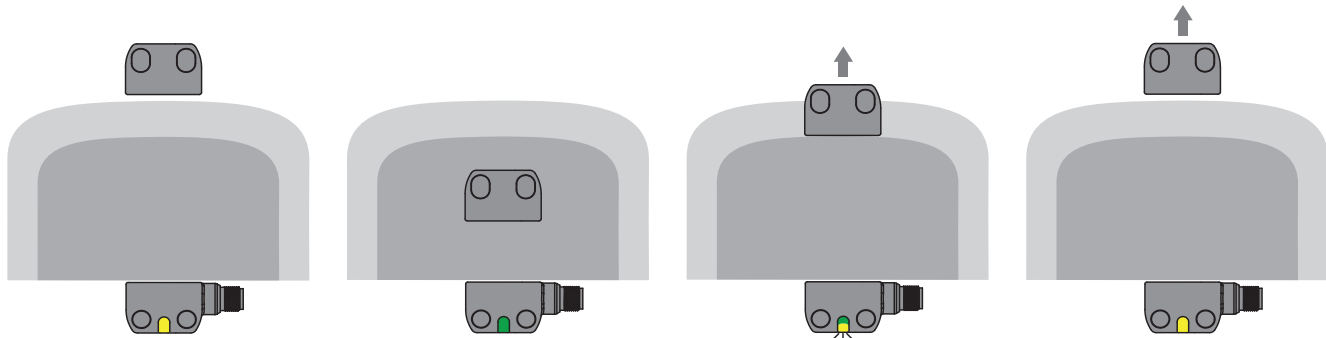

The sensor has power, the inputs are enabled, the outputs are disabled. The actuator is outside of the actuation zone. The LED is illuminated constant yellow.

If the actuator is moved inside the safe activation zone (dark grey area), the sensor activates the outputs. The LED is illuminated constant green.

When the actuator leaves the safe zone, the sensor keeps the safety outputs enabled. Entry into the limit activation zone (light grey area) is, however, indicated by the yellow LED flashing intermittently.

When the actuator leaves the limit activation zone, the sensor disables the outputs. The signalling LED illuminates again constant yellow.

### Operating distances for SM G•T, SM H•T, SM D•T, SM L•T actuators

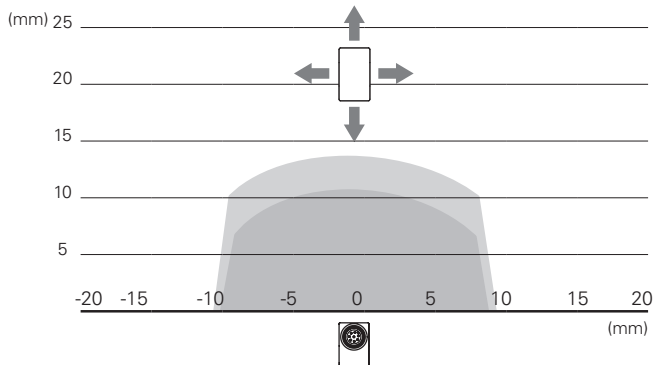
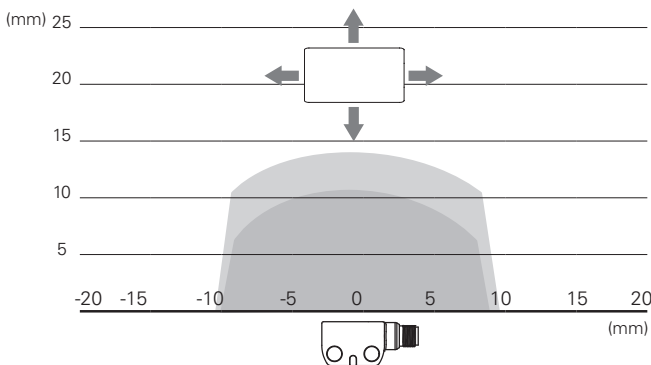

### Operating distances for SM E•T actuators

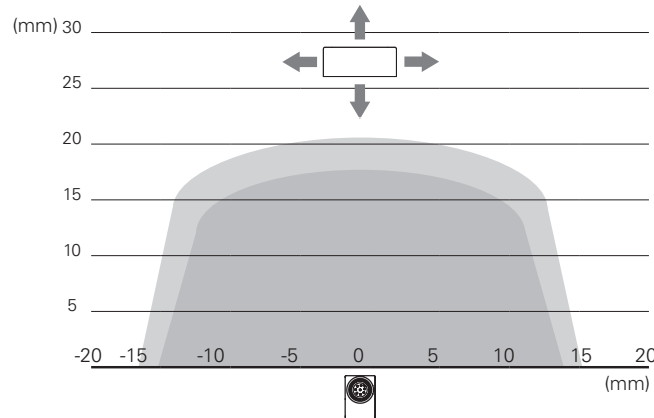
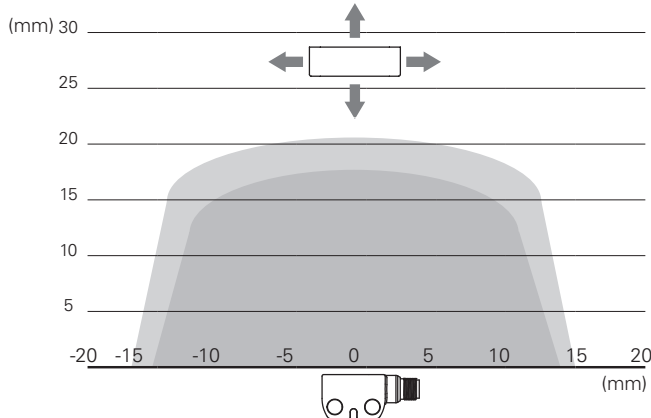

Legend:  
■ Rated operating distance  $s_n$  (mm)  
■ Rated release distance  $s_{nr}$  (mm)

**Note:** The progress of the activation areas is for reference only; the possible application on ferromagnetic surfaces can reduce the operating distances.



## Complete safety system

The use of complete and tested solutions guarantees the electrical compatibility between the sensors of the ST series and the safety modules from Pizzato Elettrica, as well as high reliability. The sensors have been tested with the modules listed in the adjacent table.

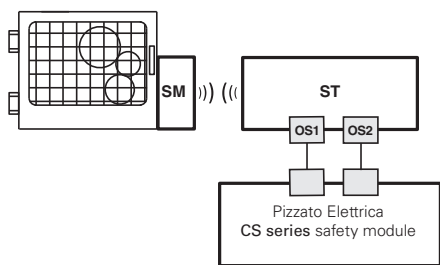

ST sensors can be used as individual devices provided that the outputs be evaluated by a Pizzato Elettrica safety module (see table for combinable safety modules).

## Compatible safety modules

Sensors	Safety modules	Safety module output contacts		
		Instantaneous safety contacts	Delayed safety contacts	Signalling contacts
ST G..... ST H.....	CS AR-01.....	2NO	/	1NC
	CS AR-02.....	3NO	/	/
	CS AR-05.....	3NO	/	1NC
	CS AR-06.....	3NO	/	1NC
	CS AR-08.....	2NO	/	/
	CS AT-0.....	2NO	2NO	1NC
	CS AT-1.....	3NO	2NO	/
	CS MP.....	see page 369		
	CS MF.....	see page 401		

All ST series sensors can be connected, provided that compatibility is checked, to safety modules or safety PLCs with OSSD inputs.

## Series connection with safety modules

Multiple ST series sensors can be **connected in series**, so as to simplify the safety system wiring. In this configuration, the safety outputs of the last sensor in the chain must be evaluated by a Pizzato Elettrica CS series safety module (see table for compatible safety modules).

Each ST sensor is additionally equipped with a **signalling output**, which – depending on the version – is activated or deactivated when the respective guard is closed. This information can be managed – according to the specific requirements of the implemented system – by a PLC or by a Pizzato Elettrica CS MP series safety module, which allows control of both safety and signalling outputs.

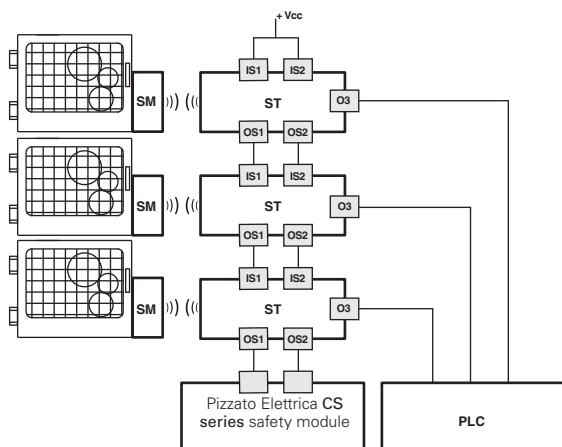

Connection with safety module and PLC

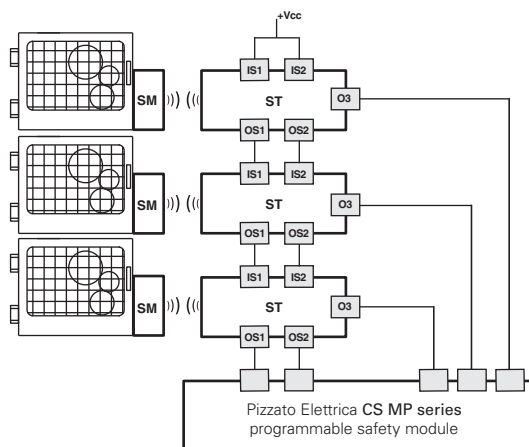

Connection with programmable safety module

## External device monitoring (EDM)

The ST \*\*5..... and ST \*\*9..... versions, in addition to maintaining the operating and safety characteristics of the ST series, allow control of **forcibly guided NC contacts of contactors or relays** controlled by the safety outputs of the sensor itself. This check is carried out by monitoring the EDM input (External Device Monitoring as defined in EN 61496-1) of the sensor.

As an alternative to the relays or contactors you can use Pizzato Elettrica expansion modules CS ME-03. See page 359.

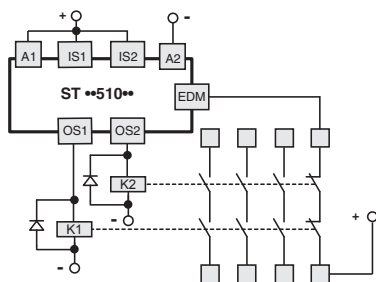

The EDM version, which is equipped with the IS safety inputs, **can be used at the end of a series** of ST sensors, **up to a maximum number of 32 devices**, while maintaining the maximum PL e safety level according to EN 13849-1.

For specific applications, this solution allows you to dispense with the safety module connected to the last device in the chain.

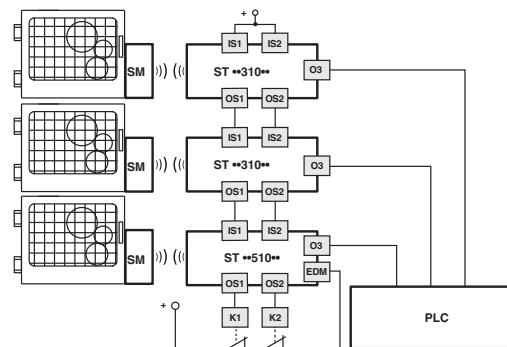

## O3 output inverted

Using versions with inverted O3 signalling output (articles ST \*\*6....., ST \*\*7....., ST \*\*8....., ST \*\*9.....) allows checking of the actual electrical connection of the sensor by an external PLC. The O3 output will be activated when the actuator is removed and the OS safety outputs are switched off.

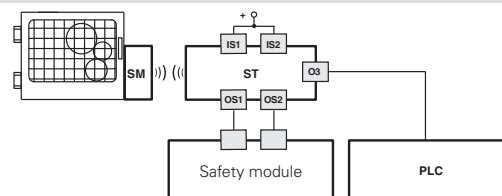



### Connection with safety modules

Connections with CS AR-08•••• safety modules

Input configuration with monitored start
2 channels / Category 4 / up to SIL 3 / PL e

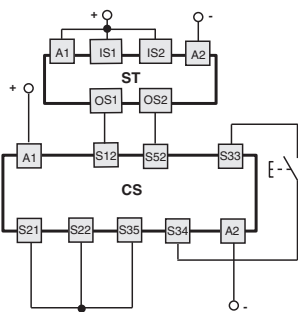

Connections with CS AT-0••••• / CS AT-1••••• safety modules

Input configuration with monitored start
2 channels / Category 4 / up to SIL 3 / PL e

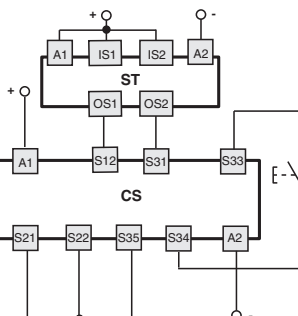

For features of the safety modules see page 305.

Connections with CS AR-05••••• / CS AR-06••••• safety modules

Input configuration with manual start (CS AR-05•••••) or monitored start (CS AR-06•••••)
2 channels / Category 4 / up to SIL 3 / PL e

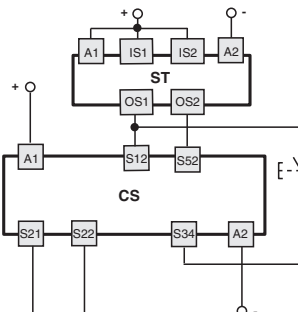

Connection with safety module CS MP•••••0

The connections vary according to the program of the module
Category 4 / up to SIL 3 / PL e

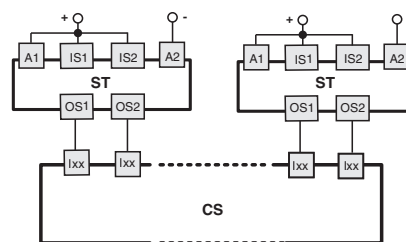

For application examples, see page 368.

### Series connection

To simplify series connections of the devices, various M12 connectors are available that allow complete wiring.

This solution significantly reduces installation times while at the same time maintaining the maximum safety levels PL e and SIL 3.

For more information see page 426.

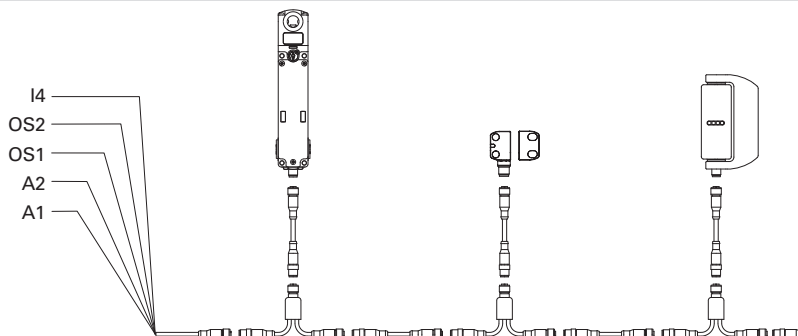

### Multitag function

This version of the device is supplied with two or more high level coded actuators, all of which can be acknowledged by the same sensor. The internal firmware of the sensor can be factory programmed, memorising up to 16 actuators and associating a different device behaviour to each of the same once the actuator has been acknowledged by the sensor.

The new multitag function lets you activate or deactivate the sensor outputs, and also send the information on which actuator is in front of the sensor, using a serial signal via the O3 signalling output. This signal can be sent and processed by a PLC.

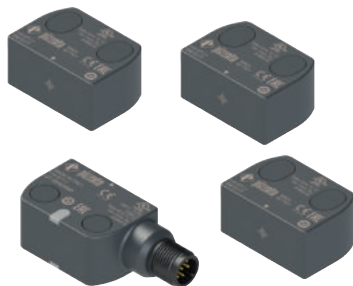

Programming code	Number of actuators	Programming
P1	2 x SM G1T	TAG0 activates the OS safety outputs TAG1 activates the O3 signalling output
P2	2 x SM G1T	TAG0 activates the OS safety outputs and sends "0" to O3 TAG1 activates the OS safety outputs and sends "1" to O3
P3	3 x SM G1T	TAG0 activates the OS safety outputs and sends "0" to O3 TAG1 activates the OS safety outputs and sends "1" to O3 TAG2 activates the OS safety outputs and sends "2" to O3
P4	4 x SM G1T	TAG0 activates the OS safety outputs and sends "0" to O3 TAG1 activates the OS safety outputs and sends "1" to O3 TAG2 activates the OS safety outputs and sends "2" to O3 TAG3 activates the OS safety outputs and sends "3" to O3

**Note:** The actuators are supplied with an indelible laser-engraved ID code.

Other programming options are available on request. Contact technical support for more information.

**Attention!** As required by EN ISO 14119 to be used in safety applications, all the actuators must be fixed immovably on the machine, and none of them can be used as a bypass to activate the device.

## Application example for ST G.....P1 articles

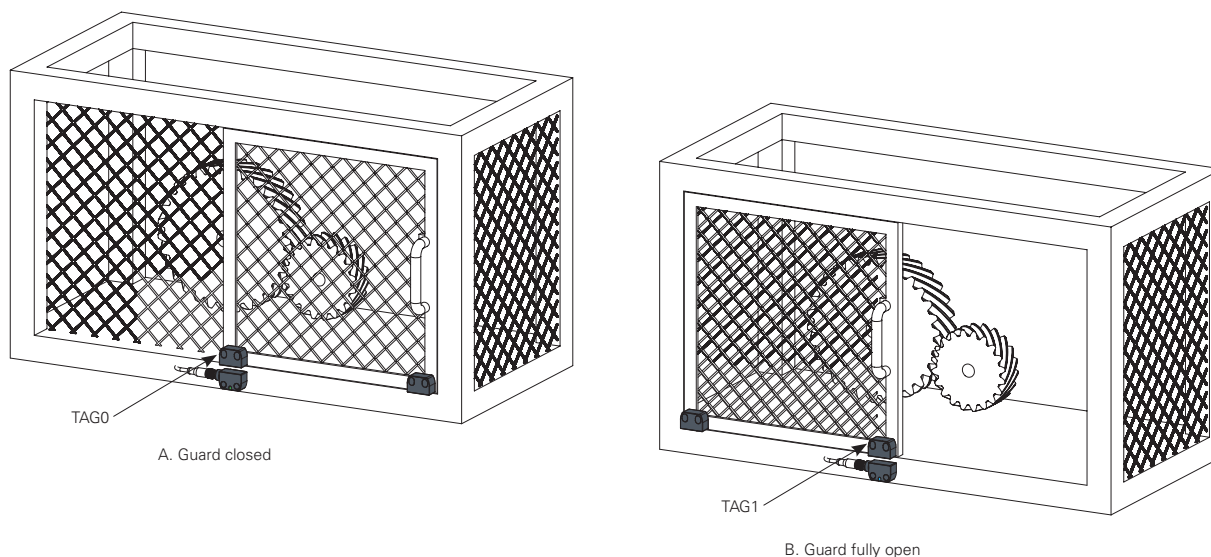

Article ST G.....P1 has a sensor with two actuators.

Compared to a traditional configuration with one single actuator, the device is able to not only recognise "guard closed" status through actuator 0 (in this case activating the OS safety outputs), but also "guard fully open" status, through actuator 1, which activates signalling output O3.

By sending this information to the machine control logic you can eliminate uncertainties caused by incomplete guard opening, increasing the precision and intrinsic safety of the machine.

This device is typically used on a press or any automatic machine in general, which uses a robot to load and unload workpieces if you want the robot to operate only when the guard is fully open.

## Application example for ST G.....P4 articles

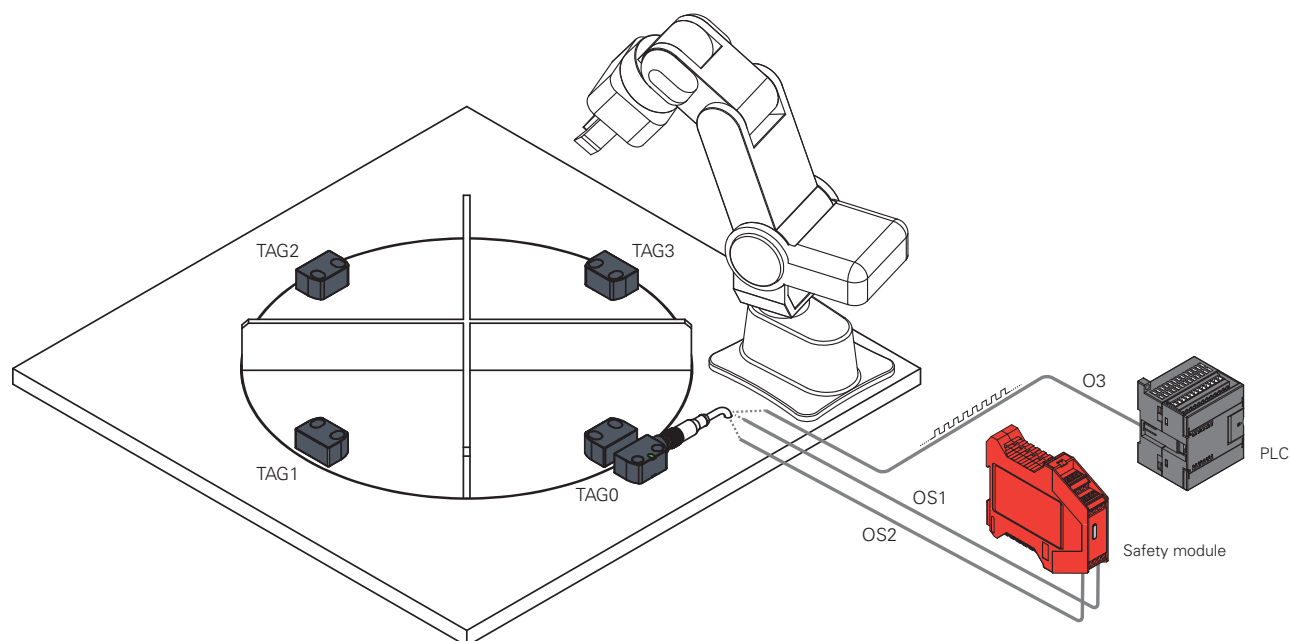

Article ST G.....P4 has a sensor with four actuators.

On a rotary table assembly station, the ST G sensor can be installed in combination with as many actuators as the available work stations (4 in the example shown).

When recognised by the sensor, each actuator activates the OS safety outputs and sends a string of bits with its ID code ("0" for TAG0, "1" for TAG1, up to "F" for TAG15, according to hexadecimal numbering). In this way, in every situation you can know which is the active work station, for example in the machine start-up phase or after an unexpected blackout.

The device has been designed for processing and assembly plants with multiple stations, robotised islands and machining centres.



## Transmission protocol on signalling output O3

The articles with multitag programming (in the special versions) can transmit an actuator identification code with a serial signal sent through the O3 signalling output when the actuator is in front of the sensor.

The information is sent in a sequence of bits (0, 1) which represents the ASCII code of the hexadecimal number associated with the actuator (TAG0 = 0, TAG1 = 1 ... TAG9 = 9, TAG10 = A ... TAG15 = F). 8 bits are required for each TAG to complete the transmission.

For example, ID code "0" of the first actuator is sent by the sensor as a sequence of the following bits:

00110000 (ASCII code: "zero" digit)

The start bit is used at the beginning of the sequence to signal the start of the transmission, while the network goes into a rest state at the end of the transmission (network idle low or equal to 0, no stop bit) for a pre-set interval of time.

All you need is a PLC with a program that can code the O3 input transmission, to process the information so it can be used in the machine control logic.

Transmission parameters		
A	Coding type:	serial
B	Bit duration:	20 ms
C	Byte length:	160 ms (8 bit)
D	Interval:	200 ms
E	Network idle:	low
F	Start bit:	1
G	Stop bit:	none

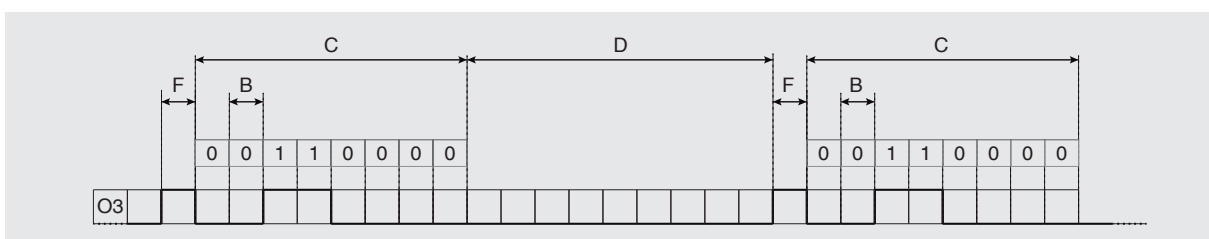

## Internal device connections

### 5-pole versions

ST ●●1●●●●, ST ●●2●●●●, ST ●●6●●●●

M12 connector	Cable	Connection
1	brown	A1 (+)
2	white	OS1
3	blue	A2 (-)
4	black	OS2
5	grey	O3 <sup>(a)</sup>

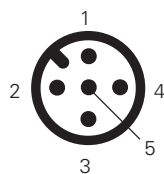

<sup>(a)</sup> deactivated output for ST ●●1●●●● articles.

### 8-pole versions

ST ●●3●●●●, ST ●●4●●●●, ST ●●5●●●●,  
ST ●●7●●●●, ST ●●8●●●●, ST ●●9●●●●

M12 connector	Cable	Connection
1	white	A1 (+)
2	brown	IS1
3	green	A2 (-)
4	yellow	OS1
5	grey	O3
6	pink	IS2
7	blue	OS2
8	red	not connected <sup>(a)</sup> I3 <sup>(b)</sup> EDM <sup>(c)</sup>

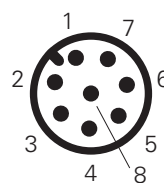

<sup>(a)</sup> for articles ST ●●3●●●●, ST ●●7●●●●.

<sup>(b)</sup> for articles ST ●●4●●●●, ST ●●8●●●●.

<sup>(c)</sup> for articles ST ●●5●●●●, ST ●●9●●●●.

### Legend

A1-A2: supply

IS1-IS2 Safety inputs

OS1-OS2: safety outputs

O3: signalling output

I3: programming input

EDM: input for monitoring of NC contacts of the contactors

**Note:** Versions with customised pin assignments are available on request.

For female connectors, see page 419.

## Ambient temperature for sensors with cable

	Connection type	Output with cable			Output with cable and M12 connector	
	Cable type	N	N	H	8x0.25 mm <sup>2</sup>	5x0.25 mm <sup>2</sup>
Cable features	Conductors	8x0.25 mm <sup>2</sup>	5x0.25 mm <sup>2</sup>	8x0.25 mm <sup>2</sup>	8x0.25 mm <sup>2</sup>	5x0.25 mm <sup>2</sup>
	Application field	General	General	General, mobile installation	General	General
	In compliance with standards	03VV5-H	03VV5-H	03E7Q-H	03VV5-H	03VV5-H
	Sheath	PVC OIL RESISTANT	PVC OIL RESISTANT	PUR Halogen Free	PVC OIL RESISTANT	PVC OIL RESISTANT
	Self-extinguishing	IEC 60332-1-2 UL 758:FT1	IEC 60332-1-2 UL 758:FT1	IEC 60332-1-2 UL 758:FT1	IEC 60332-1-2 UL 758:FT1	IEC 60332-1-2 UL 758:FT1
	Oil resistant	UL 758 CSA 22.2 N°210	UL 758 CSA 22.2 N°210	UL 758 CSA 22.2 N°210	UL 758 CSA 22.2 N°210	UL 758 CSA 22.2 N°210
	Max. speed	50 m/min.	50 m/min.	300 m/min.	50 m/min.	50 m/min.
	Max. acceleration	5 m/s <sup>2</sup>	5 m/s <sup>2</sup>	30 m/s <sup>2</sup>	5 m/s <sup>2</sup>	5 m/s <sup>2</sup>
	Minimum bending radius	90 mm	75 mm	70 mm	90 mm	75 mm
	Outer diameter	6 mm	6 mm	6 mm	6 mm	6 mm
	End stripped	80 mm	80 mm	80 mm	/	/
	Copper conductors	Class 6 IEC 60228	Class 6 IEC 60228	Class 6 IEC 60228	Class 6 IEC 60228	Class 6 IEC 60228
	Engraving	6275	6267	6284	6275	6267
Ambient temperature extended (TB) standard	Cable, fixed installation	-25°C ... +70°C	-25°C ... +70°C	-25°C ... +70°C	-25°C ... +70°C	-25°C ... +70°C
	Cable, flexible installation	-15°C ... +70°C	-15°C ... +70°C	-25°C ... +70°C	-15°C ... +70°C	-15°C ... +70°C
	Cable, mobile installation	-15°C ... +70°C	-15°C ... +70°C	-25°C ... +70°C	-15°C ... +70°C	-15°C ... +70°C
	Cable, fixed installation	-35°C ... +85°C	-35°C ... +85°C	-35°C ... +85°C	-35°C ... +85°C	-35°C ... +85°C
	Cable, flexible installation	-15°C ... +85°C	-15°C ... +85°C	-15°C ... +85°C	-15°C ... +85°C	-15°C ... +85°C
	Cable, mobile installation	-15°C ... +85°C	-15°C ... +85°C	-15°C ... +85°C	-15°C ... +85°C	-15°C ... +85°C
	Approvals	CE cULusTUV EAC	CE cULusTUV EAC	CE cULusTUV EAC	CE cULusTUV EAC	CE cULusTUV EAC

## Accessories



Article	Description
VS SP5CA1	Polyurethane foam adhesive strip for SM H•T actuators

Protective polyurethane foam strip, with adhesive, applicable on SM H•T actuators, reduces noise and force in case of impact between sensor and actuator.

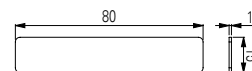

Article	Description
SM H9ZF	Door holding magnet (holding force 40 N)
SM H9ZQ	Door holding magnet (holding force 40 N, opposite polarity to SM H9ZF)

Holding magnets for use on machinery doors. The magnets are sealed inside a plastic cover and will not rust even in damp environments.

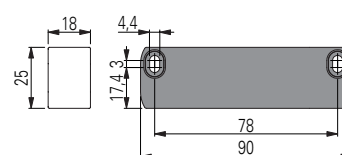



# Dimensional drawings

ST G••••N• sensor with cable

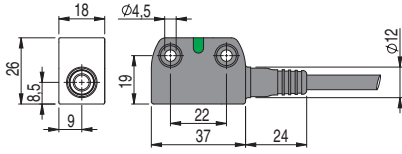

ST H••••N• sensor with cable

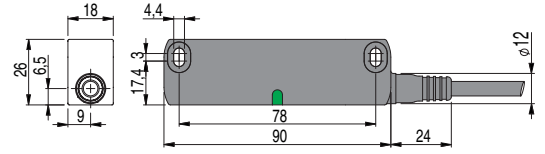

ST G••••M• sensor with M12 connector

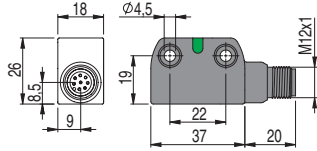

ST H••••M• sensor with M12 connector

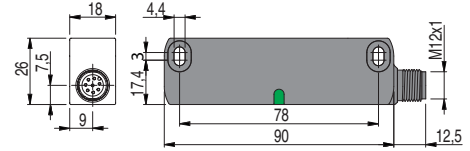

ST G••••M0.2 sensor with cable and M12 connector

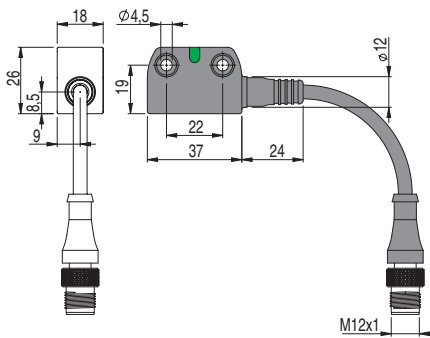

ST H••••M0.2 sensor with cable and M12 connector

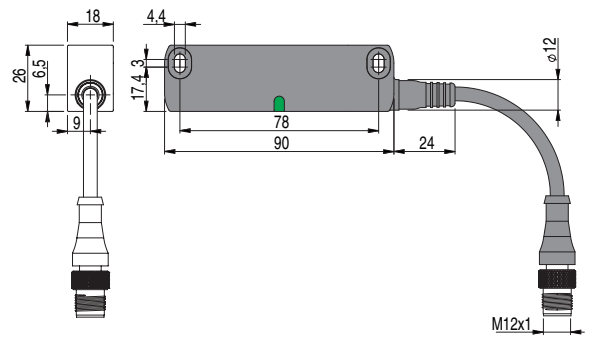

SM G•T actuator

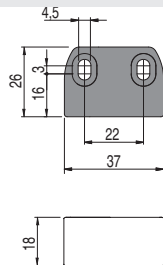

SM H•T actuator

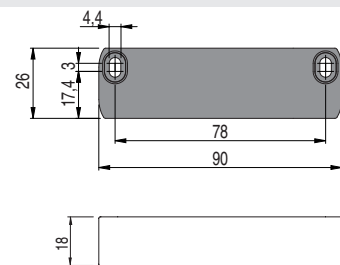

SM D•T actuator

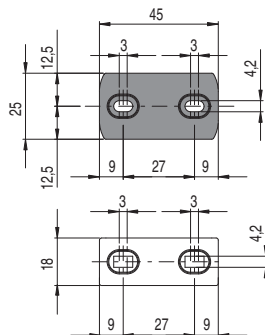

SM L•T actuator

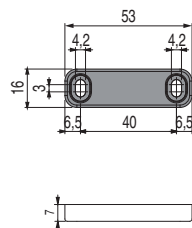

SM E•T actuator

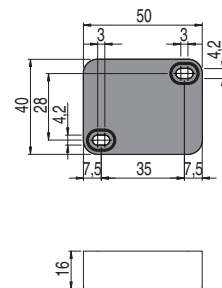

All values in the drawings are in mm

→ The 2D and 3D files are available at [www.pizzato.com](http://www.pizzato.com)