

# PRODUCT DATASHEET

## TRUSYS FLEX P 70W 865 N CL WT EM

TruSys® FLEX EMERGENCY NARROW | Luminaire inserts with narrow light distribution for standard and emergency lighting, up to 175 lm/W



### Areas of application

- Emergency illumination of escape routes
- Antipanic lighting
- Buildings requiring up to 3 h emergency light operation
- Direct replacement for luminaires with fluorescent lamps
- Industry halls, high rack warehouse, hardware stores

### Product benefits

- Seamless integration of luminaires with emergency lighting function into general lighting
- Easy wiring thanks to included prewired driver and battery for Emergency lighting function
- Simple testing of luminaires with emergency lighting function thanks to integrated automatic test function
- Convenient visualization of results of automatic test with an included control LED
- Operation of integrated emergency lighting function with long life LiFePO4 battery with 3h battery discharge time
- High luminous efficacy in normal operation
- 3 years guarantee
- Directed light distribution for high heights
- Easy installation, no tools required for connection
- Energy saving and cost-effective
- Flexible application due to a range of different lumen packages and beam angles

### Product features

- Certified according to European norms (EN 60598-1:2015; EN 60598-2-22:2014)



- Luminaire suited for normal lighting and emergency lighting
- Self-contained luminaires
- Emergency lighting function: battery discharge time of 3 h
- Function test of emergency lighting: automatic (AT)
- Battery technology: LiFePO4
- Beam angle narrow: 60°
- Click into place solution with smart click buttons
- Fixed luminaire taps
- Steel-sheet housing

## TECHNICAL DATA

### Electrical data

|   |                       |
|---|-----------------------|
| Nominal wattage   | 70.00 W               |
| Nominal voltage   | 220...240 V           |
| Mains frequency   | 50...60 Hz            |
| Nominal current   | 320.000 mA            |
| Inrush current  | 38.8 A                |
| Inrush current time $T_{h50}$                               | 230 $\mu$ s           |
| Max. number of luminaires per miniature circuit breaker B16 | 8                     |
| Max. number of luminaires per miniature circuit breaker C10 | 7                     |
| Max. number of luminaires per miniature circuit breaker C16 | 12                    |
| Power factor $\lambda$                                      | $\geq 0.95$           |
| Total harmonic distortion                                   | $\leq 15\%$           |
| Protection class  | I                     |
| Operating mode  | Integrated LED driver |

### Photometrical data

|  |                    |
|--|--------------------|
| Luminous flux                                | 12100 lm           |
| Luminous efficacy                            | 175 lm/W           |
| Color temperature                            | 6500 K             |
| Light color (designation)                    | Cool Daylight      |
| Color rendering index Ra                     | $\geq 80$          |
| Standard deviation of color matching         | 3 sdc <sub>m</sub> |
| Low flicker                                  | Yes                |
| Flickering metric (Pst LM)                   | $\leq 1$           |
| Stroboscope effect metric (SVM)              | $\leq 0.4$         |
| Photobiological safety group acc. to EN62778 | RG1                |
| Beam angle                                   | 60 °               |

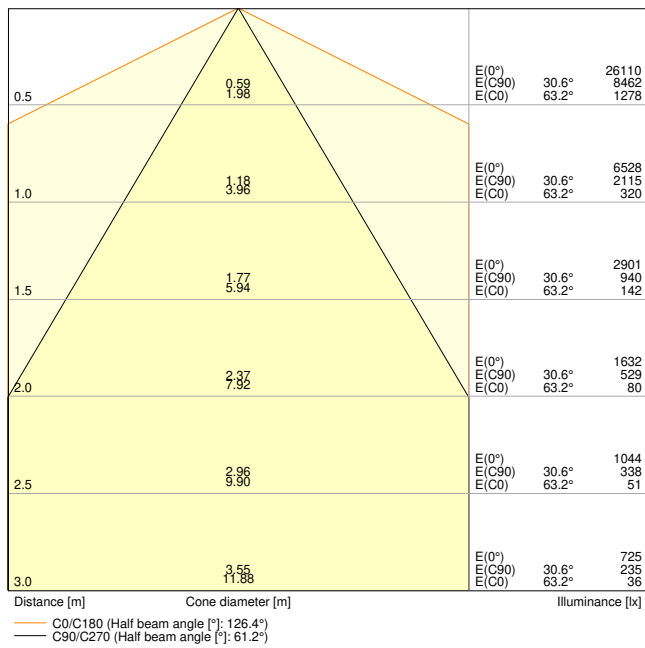

TRUSYS FLEX P 70W 865 N CL WT EM

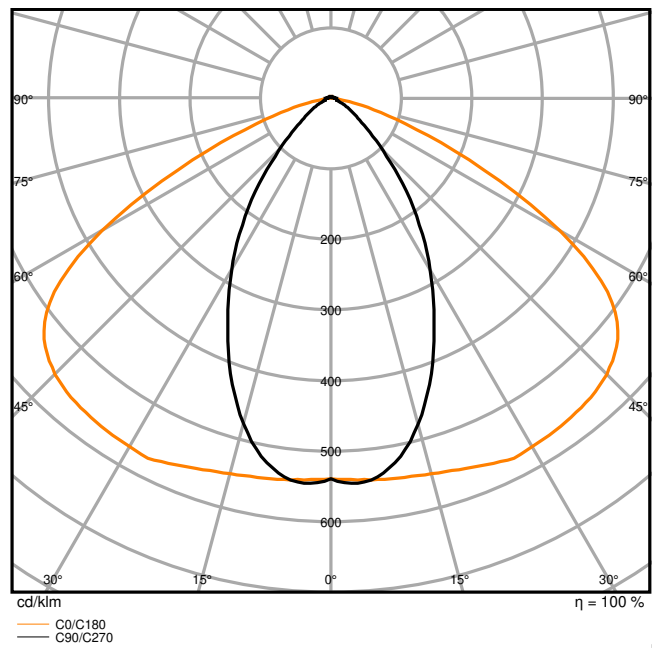

TRUSYS FLEX P 70W 865 N CL WT EM

### Dimensions & Weight

|                |            |
|----------------|------------|
| Length         | 1500.00 mm |
| Width          | 77.70 mm   |
| Height         | 39.40 mm   |
| Product weight | 2360.00 g  |

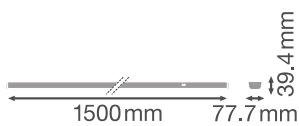

TRUSYS FLEX luminaire - clear

### Materials & Colors

|  |                               |
|--|-------------------------------|
| Product color                              | White                         |
| Housing color                              | White                         |
| Body material                              | Steel                         |
| Cover material                             | Polymethylmethacrylate (PMMA) |
| Light emitting surface material            | Polymethylmethacrylate (PMMA) |
| Glow Wire Test according to IEC 60695-2-12 | 650 °C                        |
| Mercury content                            | 0.0 mg                        |

### Application & Mounting

|  |                    |
|--|--------------------|
| Ambient temperature range              | 0...+40 °C         |
| Temperature range at storage           | -40...+80 °C       |
| Type of connection                     | Plug-In connection |
| Type of protection                     | IP40               |
| Protection class IK (shock resistance) | IK04               |
| Dimmable                               | No                 |
| Mounting type                          | Suspended/Surface  |
| Mounting location                      | Mounting rail      |
| Application environment                | Indoor             |
| Adjustable                             | No                 |
| With light source                      | Yes                |

### Lifespan

|                            |                        |
|----------------------------|------------------------|
| Lifespan L70/B50 at 25 °C  | 100000 h <sup>1)</sup> |
| Lifespan L80/B10 at 25 °C  | 76000 h <sup>1)</sup>  |
| Lifespan L80/B50 at 25 °C  | 89000 h                |
| Lifespan L90/B10 at 25 °C  | 43000 h                |
| Number of switching cycles | 100000                 |

<sup>1)</sup> t[h]: L70 / B50 @ 25 °C (Ta), t[h]: L80 / B10 @ 25 °C (Ta), t[h]: L90 / B10 @ 25 °C (Ta)

### Control gear

|                             |         |
|-----------------------------|---------|
| Output current              | 1000 mA |
| ECG - Output ripple current | < 5 %   |

### BATTERY

|                    |         |
|--------------------|---------|
| Type of Battery    | LiFePO4 |
| Battery size [GMS] | Others  |

|                             |          |
|-----------------------------|----------|
| Nominal voltage of battery  | 3.2 V    |
| Nominal capacity of battery | 9000 mAh |
| Battery charging time       | 24 h     |

### Emergency lighting

|  |   |
|--|---|
| Area of emergency application              | Anti-panic lighting / Escape route lighting |
| Type of emergency light operation          | Non-maintained / Maintained                 |
| Type of emergency operation test           | Automatic                                   |
| Wattage in maintained operation mode       | 70 W  |
| Wattage in emergency operation mode        | 4 W   |
| Luminous flux in maintained operation mode | 12100 lm                                    |
| Luminous flux in emergency operation mode  | 740 lm                                      |
| Battery life in emergency operation mode   | 3 h   |





### Certificates & Standards











|  |                             |
|--|-----------------------------|
| Standards  | CE / CB / UKCA / ENEC / EAC |
| Luminaire with limited surface temperature, "D sign" | Yes                         |
| Ball shot safe                                       | No                          |
| Replaceable light source (EPREL)                     | Not replaceable             |

### EQUIPMENT / ACCESSORIES

– Mounting rail with fixed integrated 8-pole cable

### DOWNLOAD DATA

| Documents and certificates   |  | Document name                      |
|--|--|------------------------------------|
|  | User instruction / safety instructions | TRUSYS FLEX EMERGENCY 865          |
|  | Legal information                      | Legal insert TRUSYS FLEX P EM      |
|  | Legal information                      | LSI TRUSYS FLEX 865 EM             |
|  | Legal information                      | Informationstext 18 Abs 4 ElektroG |
|  | Declarations of conformity             | TRUSYS FLEX EM                     |

| Documents and certificates   |                                     | Document name                                      |
|--|-------------------------------------|--|
|    | Declarations of conformity UKCA     | TRUSYS FLEX EM                                     |
|    | Certificates                        | ENEC Certificate Trusys Flex EM                    |
| Photometric and lighting design files  |                                     | Document name                                      |
|    | IES file (IES)                      | TRUSYS FLEX P 70W 865 N CL WT EM                   |
|    | LDT file (Eulumdat)                 | TRUSYS FLEX P 70W 865 N CL WT EM                   |
|    | ULD file (DIALux)                   | TRUSYS FLEX P 70W 865 N CL WT EM                   |
|    | ROLF file (RELUX)                   | TRUSYS FLEX P 70W 865 W CL WT EM                   |
|    | UGR file (UGR table)                | TRUSYS FLEX P 70W 865 N CL WT EM                   |
|   | Light distribution curve type cone  | TRUSYS FLEX P 70W 865 N CL WT EM                   |
|  | Light distribution curve type polar | TRUSYS FLEX P 70W 865 N CL WT EM                   |
| CAD/BIM files  |                                     | Document name                                      |
|  | CAD STEP 3D                         | TruSys FLEX  |
| Tender texts   |                                     | Document name                                      |
|  | Tender documents                    | TruSys FLEX EMERGENCY NARROW 70W 865 N CL WT EM-EN |

**LOGISTICAL DATA**

| Product code  | Packaging unit (Pieces/Unit) | Dimensions (length x width x height) | Gross weight | Volume                |
|---------------|------------------------------|--------------------------------------|--------------|-----------------------|
| 4099854191954 | Folding box<br>1             | 108 mm x 1,534 mm x 102 mm           | 2535.00 g    | 16.90 dm <sup>3</sup> |
| 4099854191961 | Shipping box<br>4            | 1,547 mm x 218 mm x 231 mm           | 10933.00 g   | 77.90 dm <sup>3</sup> |

The mentioned product code describes the smallest quantity unit which can be ordered. One shipping unit can contain one or more single products. When placing an order, for the quantity please enter single or multiples of a shipping unit.

**ADDITIONAL CATALOG INFORMATION**

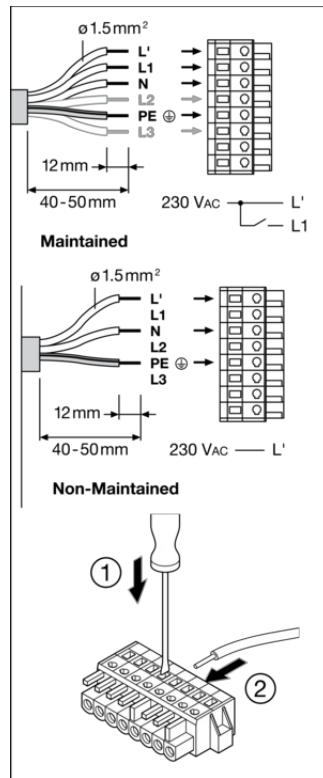

| Luminaire Status         | Control LED                |
|--------------------------|----------------------------|
| Normal                   | Green                      |
| Emergency                | OFF                        |
| Testing                  | Green:    (1s, 1s, 1s ...) |
| Battery connection fault | Red:    (1s, 1s, 1s ...)   |
| Battery capacity fault   | Red                        |
| Luminaire fault          | Red:    (4s, 4s, 4s ...)   |

| Test   |                                    |
|--|------------------------------------|
| Initialization  ≥ 48h Normal                   | Automatic                          |
| Daily check of Control LED                     | Green                              |
| Monthly/Weekly functional test (EN 50178)  30s | Automatic test once every 7 days   |
| Yearly duration test (EN 50178)  13h           | Automatic test once every 12 weeks |

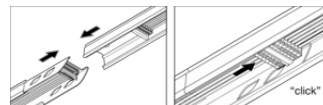

## References / Links

– For Guarantee see [www.ledvance.com/guarantee](http://www.ledvance.com/guarantee)

## DISCLAIMER

Subject to change without notice. Errors and omission excepted. Always make sure to use the most recent release.