

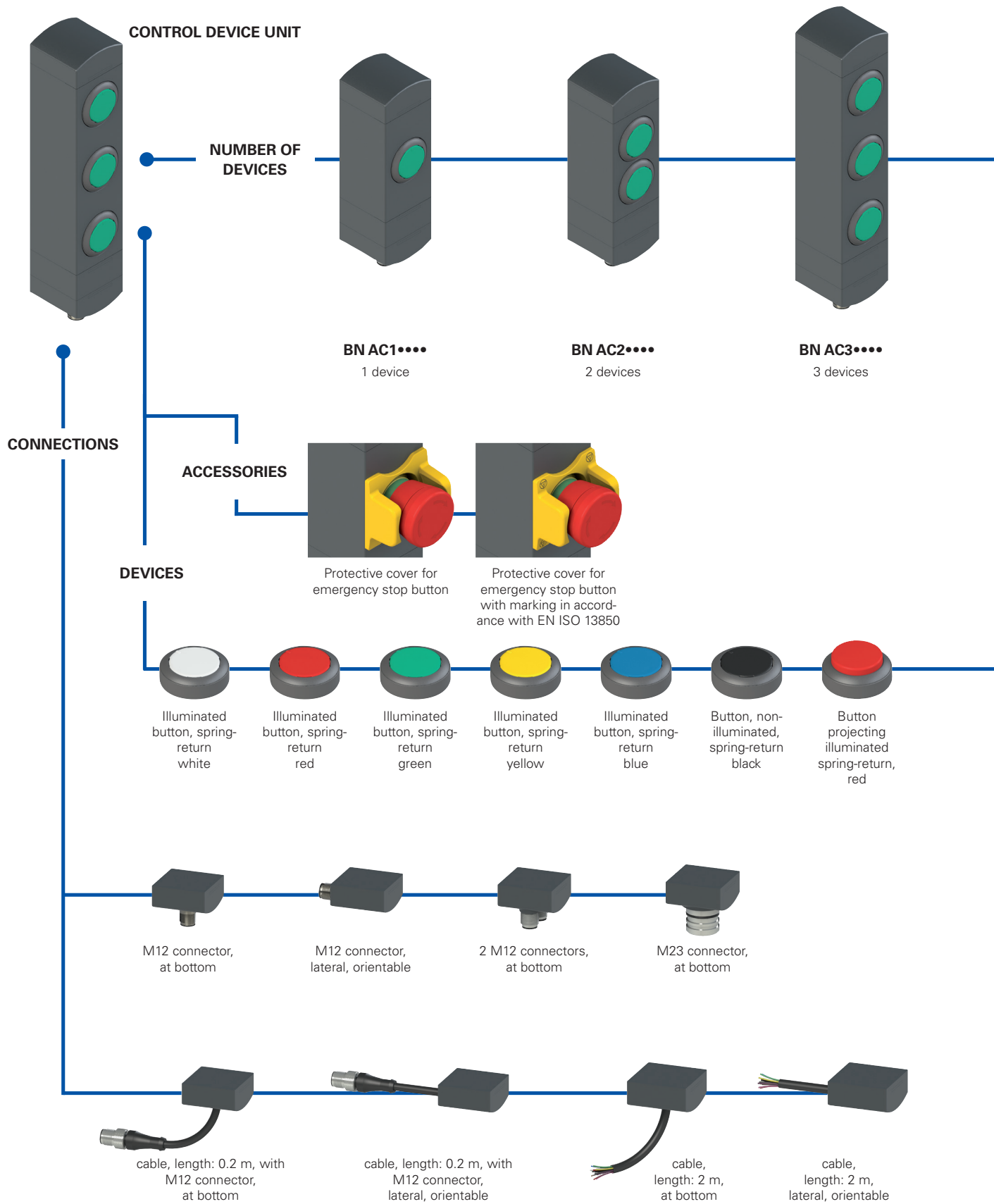

BN series control device units



Selection diagram



● product option
 → Sold separately as accessory

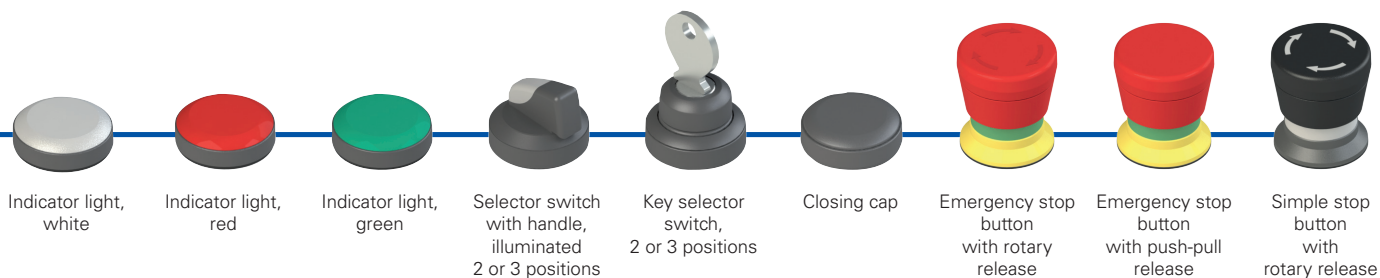
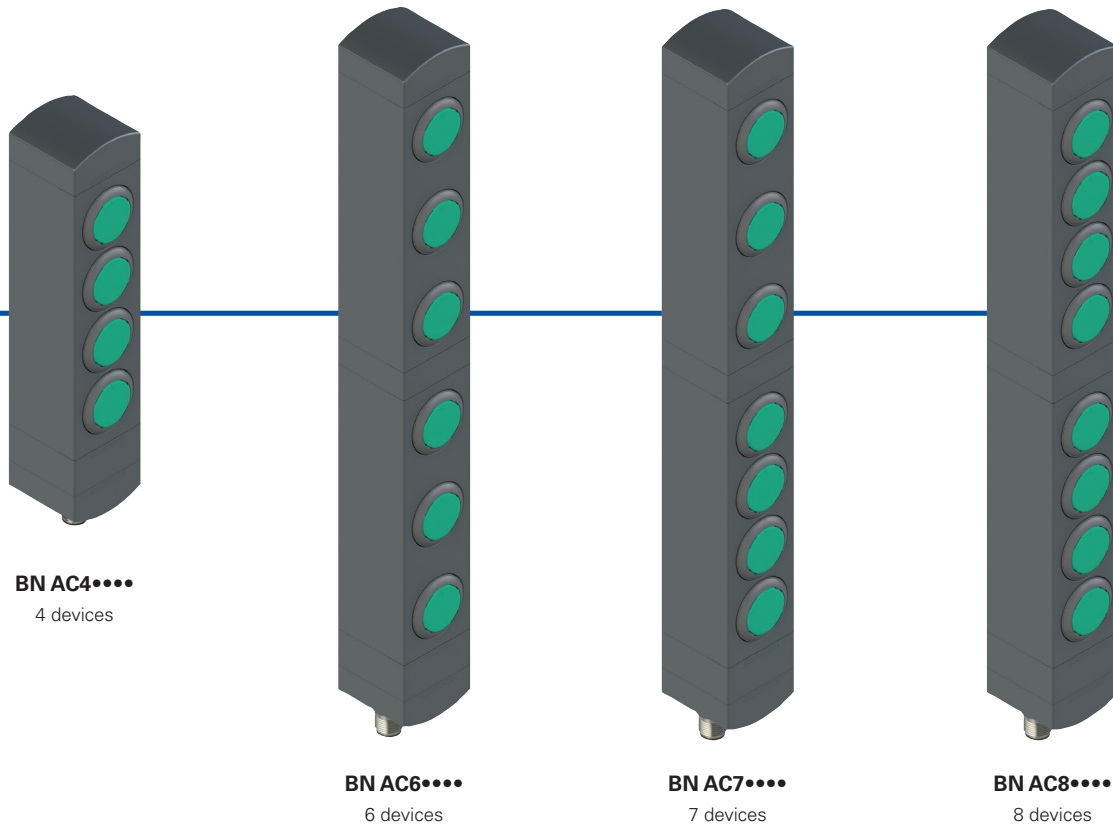

Code structure **Attention!** The feasibility of a code number does not mean the effective availability of a product. Please contact our sales office.

BN AC3ZA01

Number of devices	
1	1 device
2	2 devices
3	3 devices
4	4 devices
6	6 devices
7	7 devices
8	8 devices

Button and connector configuration	
A01	A01 configuration
A02	A02 configuration
A03	A03 configuration
...	other configurations on request



Main features

- Modular control device unit for 1 to 8 devices
- Rotatable fixing position
- Flush-mounted control devices
- Compact dimensions, minimal housing width
- Numerous control devices available

Quality marks:



UL approval: E131787

Features approved by UL

Electrical ratings: 24 Vdc Class 2, 0,1 A

Model BN with base module dimensions 40 mm by 38.5 mm by 145.5 mm:

Input Supplied by 24 Vdc, Class 2 Source or limited voltage limited energy, 0,096 A max. (Maximum eight leds).

Output 24 Vac/dc "Class 2" 0,25 A Pilot Duty (Maximum eight Actuators, with maximum twelve contacts, NO or NC or both) or 0,18 A Pilot Duty (Maximum eight Actuators, with maximum sixteen contacts, NO or NC or both)

Model BN with base module dimensions 40 mm by 38.5 mm by 82.1 mm:

Input Supplied by 24 Vdc, Class 2 Source or limited voltage limited energy, 0,048 A max. (Maximum four leds).

Output 24 Vac/dc "Class 2" 0,25 A Pilot Duty (Maximum four Actuators, with maximum eight contacts, NO or NC or both) or 0,18 A Pilot Duty (Maximum four Actuators, with maximum eight contacts, NO or NC or both)

Environmental ratings: Type 1

Technical data

Housing made of glass fibre reinforced technopolymer, self-extinguishing and shock-proof.
Versions with 12x0.14 mm² or 8x0.25 mm² integrated cable, length 2 m, other lengths from 0.5 to 10 m on request

Versions with integrated M12 stainless steel connector, single or double, or with M23 connector
Versions with 2 m cable and M12 connector, other lengths from 0.1 ... 3 m on request
Protection degree: IP65 acc. to EN 60529

General data

Ambient temperature:	-25°C ... +70°C
Storage temperature:	-40°C ... +80°C
Fixing screws for the housing:	2 x M5, tightening torque 3 Nm
Fixing screws for turnable modules:	Tightening torque of 0.8 ... 1.2 Nm
External protection fuse:	1 A type Gg or equivalent device

Technical data of control devices

Mechanical endurance:	
Spring-return button:	1 million operating cycles
Emergency stop button:	50,000 operating cycles
Selector switch:	300,000 operating cycles
Key selector switch:	50,000 operating cycles
	30,000 operating cycles including removal of the key
	130,000 (emergency stop button)

Safety parameter B_{10D} :

Actuating force:

Spring-return button:	min. 4 N	max. 100 N
Emergency stop button:	min. 20 N	max. 100 N
Selector switch:	min. 0.1 Nm	max. 1.5 Nm
Key selector switch:	min. 0.1 Nm	max. 1.3 Nm

Material of the contacts:

Contact type:

	silver contacts
	Self-cleaning contacts with double interruption
Thermal current I_{th} :	1 A
Rated insulation voltage U_i :	32 Vac/dc
Rated impulse withstand voltage U_{imp} :	1.5 kV
Utilization category of the contact block:	DC-13; $U_e = 24 V$, $I_e = 0.55 A$
LED supply voltage:	24 Vdc $\pm 15\%$
Single LED supply current:	12 mA

M12 connector electrical data

Max. operating voltage:	32 Vac/dc
Max. operating current:	max. 1.5 A

M23 connector electrical data

Max. operating voltage:	32 Vac/dc
Max. operating current:	max. 3 A

In compliance with standards:

IEC 60947-5-1, IEC 60947-5-5, EN ISO 13850, UL 508, CSA C22.2 No. 14.

Compliance with the requirements of:

Machinery Directive 2006/42/EC, Low Voltage Directive 2014/35/EU, EMC Directive 2014/30/EU, RoHS Directive 2011/65/EU.

⚠ Installation for safety applications:

Always connect the safety circuit to the NC contacts (normally closed contacts) as stated in standard EN 60947-5-1.

Actuation of the control devices from various directions

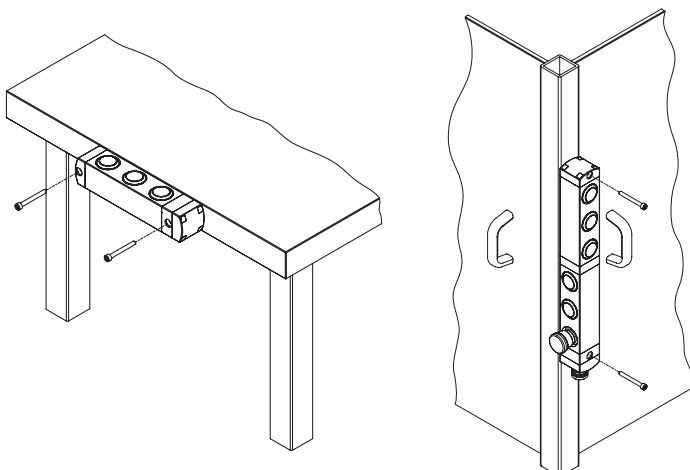

Thanks to the design with turnable modules, the control device units of the BN series offer the user many different options for fixing to the machine.

The orientation of the control devices can be selected independent of the fastening.

With the configurations for 6, 7 and 8 devices, the upper and lower part can be oriented independent of one another. This is especially useful if it should be possible to achieve a command state from two different sides of the machine. In these cases, a single device and single wiring harness can be used, thereby saving time and money.



General data



The new modular control device units of the BN series from Pizzato Elettrica can be combined perfectly with the RFID safety switches with lock of the NS series. Machine manufacturers who already use these products thereby have the possibility to attach a control device unit directly next to the safety switch that is identical in shape and dimensions.

The control device units of the BN series are available in configurations with 1 to 8 devices.

The unique design with individually turnable modules allows the user to select from a number of combinations. He receives a very versatile product that is immediately ready for use.

Compatibility with NS series switches

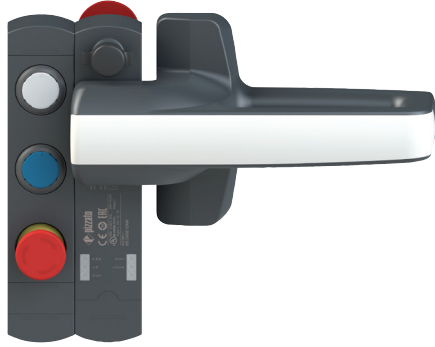

The control device units of the BN series have the same dimensions as the RFID safety switches with lock of the NS series. When mounted directly to the side of the switch, one obtains an integrated safety device whose components are made of the same material and have identical dimensions.

Minimal dimensions



One special feature of the control device units of the BN series is the slim thickness of just 40 mm.

The control devices are embedded in the housing of the unit and protrude only slightly out of the front.

This protects the control devices from unintended impacts, thereby increasing the service life of the devices and, at the same time, giving the devices an attractive design, making them predestined for use on modern machines in which this aspect is also given special consideration.

Turnable and non-detachable modules

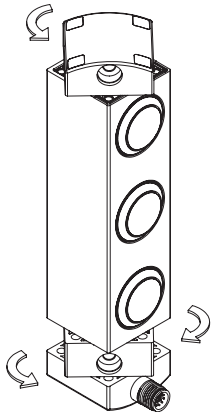

During installation, the fixing modules can be turned on the top and bottom of the device to enable variable orientation of the control devices.

Operation is very simple: after loosening the fixing screws, the device body can be turned in steps of 90° and fixed in the desired position. Another advantage for the installer is that the fixing modules cannot be detached from the device body. Disassembly of the individual parts is not necessary and there is no risk of losing parts or reassembling incorrectly.

Protection against tampering

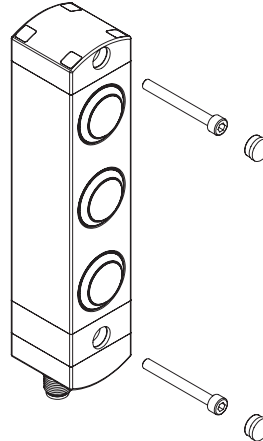

Each control device unit of the BN series is supplied complete with snap-on protection caps to be applied on the holes of the fixing screws. Not only do the caps prevent deposits of dirt from accumulating and simplify cleaning, they also prevent access to the fixing screws of the device, thereby offering increased protection against tampering.

Individually and freely configurable

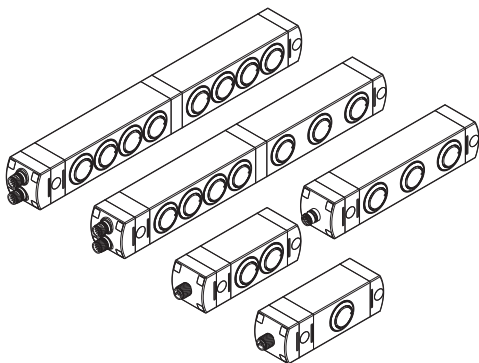

The control device unit is available in various configurations: for standard applications there are configurations with 1 to 4 devices, while configurations with 6, 7 or 8 devices are available for more complex applications that allow a larger number of control and signalling devices to be attached at the same location for the user.

Removable and laser-markable lenses



With all product configurations, a number of devices can be installed that can also be illuminated via LEDs integrated in the device.

The buttons are equipped with removable lenses that can be laser-marked for a resistant, indelible engraving. This allows customization of the lenses with a wide range of text and symbols, and replacement with lenses of a different colour or with different markings. For a full list of available markings, see the tables on pp. 165-168 of the General Catalogue HMI 2023-2024.

Protection guard for emergency stop button





The mushroom-shaped emergency stop button can be combined with a yellow protection guard that serves to protect the device from shocks. The protection guard can also be provided with a laser marking in accordance with EN ISO 13850.

Examples of available configurations

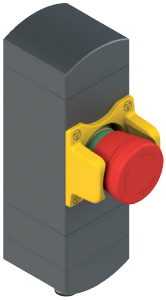
BN AC1ZA12

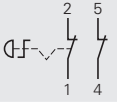

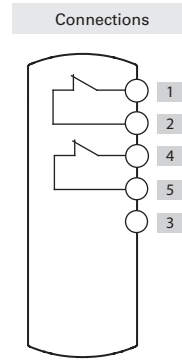

	Description	Colour	Diagram
Device 1	Emergency stop button with rotary release 2NC, with laser-marked protection guard "Ⓢ"	 red	
Connector	M12, 5-pole at bottom	/	



BN AC1ZA02



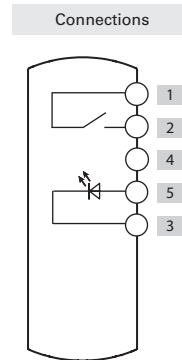

	Description	Colour	Diagram
Device 1	Illuminated button, spring-return 1NO	 white	
Connector	M12, 5-pole, at bottom	/	



BN AC1ZA03

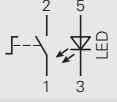

	Description	Colour	Diagram
Device 1	Illuminated selector switch with handle with two positions 1NO	 black	
Connector	M12, 5-pole, at bottom	/	

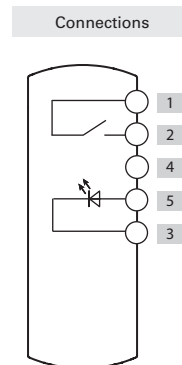



BN AC2ZA26

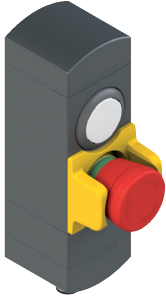

	Description	Colour	Diagram
Device 1	Illuminated button, spring-return 1NO	white	
Device 2	Emergency stop button with rotary release 2NC, with protection guard	red	
Connector	M12, 8-pole, at bottom	/	

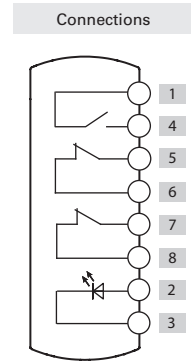

BN AC2ZA02

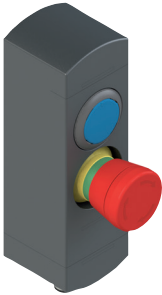

	Description	Colour	Diagram
Device 1	Illuminated button, spring-return 1NO	blue	
Device 2	Emergency stop button with rotary release 2NC	red	
Connector	M12, 8-pole, at bottom	/	

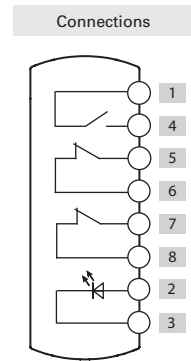

BN AC2ZA03



	Description	Colour	Diagram
Device 1	Illuminated button, spring-return 1NO	white	
Device 2	Illuminated button, spring-return 1NO	blue	
Connector	M12, 8-pole, at bottom	/	

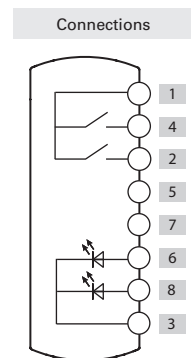

BN series control device units

BN AC3ZA01



	Description	Colour	Diagram
Device 1	Illuminated button, spring-return 1NO	white	
Device 2	Illuminated button, spring-return 1NO	blue	
Device 3	Illuminated button, spring-return 1NO	yellow	
Connector	M12, 12-pole, at bottom	/	

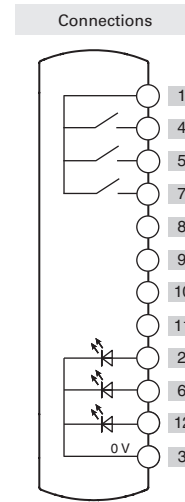

BN AC3ZB59



	Description	Colour	Diagram
Device 1	Illuminated button, spring-return 1NO	white	
Device 2	Illuminated button, spring-return 1NO	blue	
Device 3	Emergency stop button with rotary release 2NC, with laser-marked protection guard "⊗"	red	
Connector	M12, 12-pole, at bottom	/	

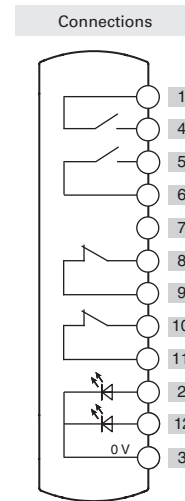

BN AC3ZA03



	Description	Colour	Diagram
Device 1	Illuminated button, spring-return 1NO	white	
Device 2	Illuminated button, spring-return 1NO	yellow	
Device 3	Emergency stop button with rotary release 2NC	red	
Connector	M12, 12-pole, at bottom	/	

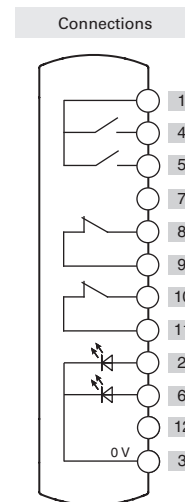



BN AC4ZA01

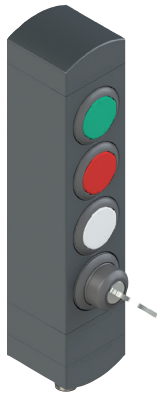

	Description	Colour	Diagram
Device 1	Illuminated button, spring-return 1NO	green	
Device 2	Illuminated button, spring-return 1NO	red	
Device 3	Illuminated button, spring-return 1NO	white	
Device 4	Two-position key selector switch 1NO	black	
Connector	M12, 12-pole, at bottom	/	

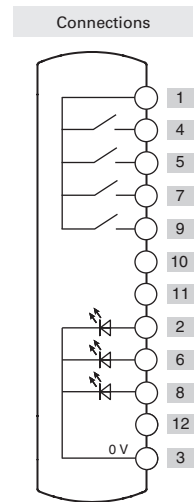

BN AC4ZB19

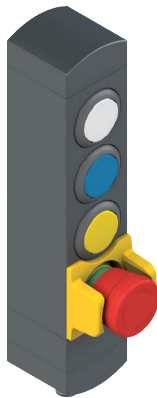

	Description	Colour	Diagram
Device 1	Illuminated button, spring-return 1NO	white	
Device 2	Illuminated button, spring-return 1NO	blue	
Device 3	Illuminated button, spring-return 1NO	yellow	
Device 4	Emergency stop button with rotary release 2NC, with protection guard	red	
Connector	M12, 12-pole, at bottom	/	

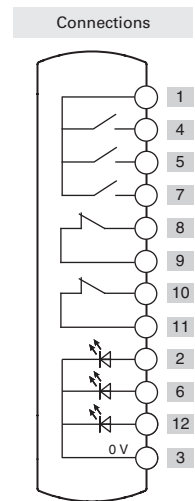

BN AC4ZA03

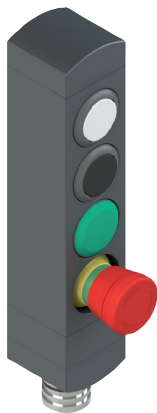

	Description	Colour	Diagram
Device 1	Illuminated button, spring-return 1NO	white	
Device 2	Spring-return button 1NO	black	
Device 3	Indicator light	green	
Device 4	Emergency stop button with rotary release 2NC	red	
Connector	M23, 12-pole, at bottom	/	

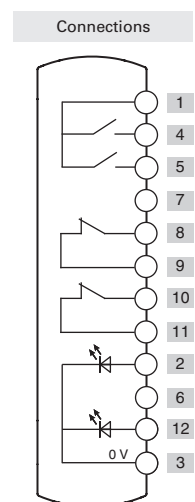

BN series control device units

BN AC6ZA40

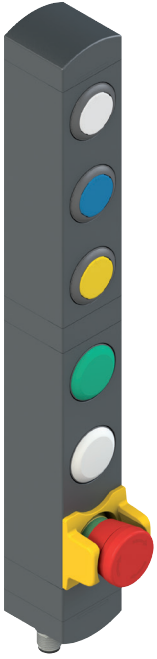

	Description	Colour	Diagram
Device 1	Illuminated button, spring-return 1NO	white	
Device 2	Illuminated button, spring-return 1NO	blue	
Device 3	Illuminated button, spring-return 1NO	yellow	
Device 4	Indicator light	green	
Device 5	Indicator light	white	
Device 6	Emergency stop button with rotary release 2NC, with protection guard	red	
Connector	Two M12, 12-pole, at bottom	/	

Connections

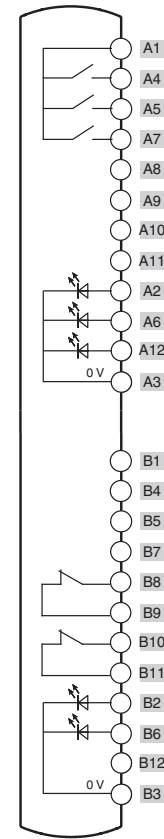

BN AC6ZA02

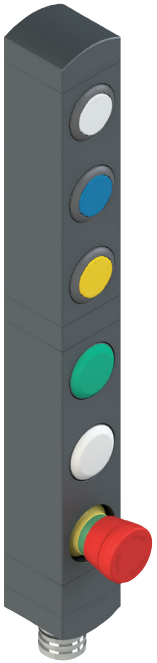

	Description	Colour	Diagram
Device 1	Illuminated button, spring-return 1NO	white	
Device 2	Illuminated button, spring-return 1NO	blue	
Device 3	Illuminated button, spring-return 1NO	yellow	
Device 4	Indicator light	green	
Device 5	Indicator light	white	
Device 6	Emergency stop button with rotary release 2NC	red	
Connector	M23, 19-pole, at bottom	/	

Connections

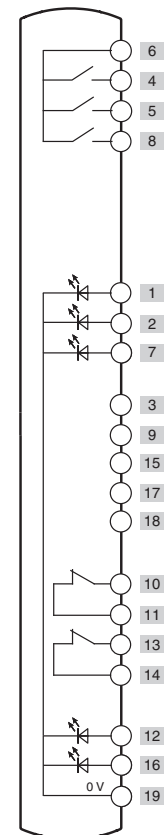



BN AC7ZA07

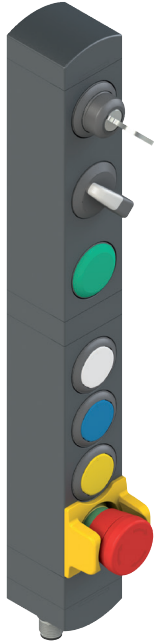

	Description	Colour	Diagram
Device 1	Two-position key selector switch 1NO	black	
Device 2	Illuminated selector switch with handle with two positions 1NO	black	
Device 3	Indicator light	green	
Device 4	Illuminated button, spring-return 1NO	white	
Device 5	Illuminated button, spring-return 1NO	blue	
Device 6	Illuminated button, spring-return 1NO	yellow	
Device 7	Emergency stop button with rotary release 2NC, with protection guard	red	
Connector	Two M12, 12-pole, at bottom	/	

Connections

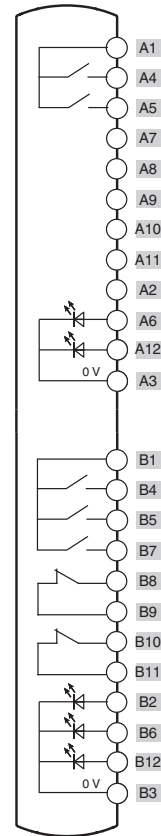

BN AC8ZA01

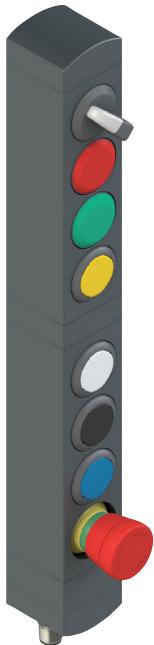





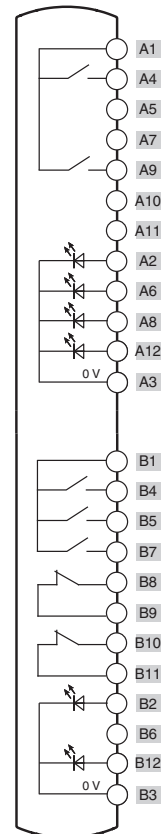



	Description	Colour	Diagram
Device 1	Illuminated selector switch with handle with two positions 1NO	black	
Device 2	Indicator light	red	
Device 3	Indicator light	green	
Device 4	Illuminated button, spring-return 1NO	yellow	
Device 5	Illuminated button, spring-return 1NO	white	
Device 6	Spring-return button 1NO	black	
Device 7	Illuminated button, spring-return 1NO	blue	
Device 8	Emergency stop button with rotary release 2NC	red	
Connector	Two M12, 12-pole, at bottom	/	

Connections



For pin assignments of the connectors, see page 12

Available control devices

	Description	Colour	Spare part number	Combinable with contacts ⁽¹⁾	Protrusion (x) mm
	Illuminated button, spring-return	<ul style="list-style-type: none"> ● White ● Red ● Green ● Yellow ● Blue 	VN NG-AC27121 VN NG-AC27123 VN NG-AC27124 VN NG-AC27125 VN NG-AC27126	1NO (1NC) (2NO) (1NO+1NC)	3
	Non-illuminated button, spring-return	● Black	VN NG-AC27122	1NO (1NC) (2NO) (1NO+1NC)	3
	Non-laser-markable, illuminated, projecting spring-return push button	● Red	VN NG-AC26018	1NO (1NC) (2NO) (1NO+1NC)	6,1
	Indicator light	<ul style="list-style-type: none"> ● Red ● Yellow ● Green ● Blue ● White 	VN NG-AC26060 VN NG-AC26061 VN NG-AC26062 VN NG-AC26063 VN NG-AC26064	/	2,7
	Emergency stop button acc. to EN ISO 13850 Rotary release Push-pull release	<ul style="list-style-type: none"> ● Red ● Red 	VN NG-AC26052 VN NG-AC26055	2NC	26,4
	Emergency stop button acc. to EN ISO 13850 for 2NC + 1NO contacts, spring-return ⁽²⁾ Rotary release	● Red	VN NG-AC26056	2NC + 1NO, spring-return	26,4
	Illuminated emergency stop button acc. to EN ISO 13850 Rotary release Push-pull release	<ul style="list-style-type: none"> ● Red ● Red 	VN NG-AC26051 VN NG-AC26054	2NC	26,4
	Simple stop button Rotary release Push-pull release	<ul style="list-style-type: none"> ● Black ● Black 	VN NG-AC26053 VN NG-AC26057	2NC	26,4
	Illuminated selector switch with handle with 2 or 3 positions and transparent lens for LED <ul style="list-style-type: none"> ✓ ▷ ▽ ◁▷ 	<ul style="list-style-type: none"> ● Black ● Black ● Black ● Black 	VN NG-AC26033 VN NG-AC26030 VN NG-AC26034 VN NG-AC26031	1NO (1NC) (2NO) (1NO+1NC)	16,8
	Key selector switch, 2 or 3 positions <ul style="list-style-type: none"> ⌘ ▷ ◁▷ 	<ul style="list-style-type: none"> ● Black ● Black ● Black 	VN NG-AC26043 VN NG-AC26040 VN NG-AC26041	1NO (1NC) (2NO) (1NO+1NC)	39 (a) 14 (b)
	Closing cap	● Black	VN NG-AC26020	/	2,7
	Fixing key	● Black	VN NG-AC26080	/	/

Legend: ✓ Maintained ▷ Spring-return ⌘ Key extraction position (a) with key (b) without key

⁽¹⁾ The contacts in brackets are on request. Contact our technical department to verify the effective feasibility of the control device unit with the chosen combination of control devices.

⁽²⁾ The NO contact with spring-return is only activated if the emergency stop button reaches the limit of travel. The signal of the NO contact is captured by analysing the rising edge.

To order buttons with marking:

add the marking code indicated in the tables on pp. 165-168 of the General Catalogue HMI 2023-2024 to the article codes.

Example: Black spring-return button with "O" engraving.

VN NG-AC27122 → VN NG-AC27122-L1



Technical data of the control devices

General data

Protection degree:	IP65 acc. to EN 60529	
Mechanical endurance:		
Spring-return button:	1 million operating cycles	
Emergency stop button:	50,000 operating cycles	
Selector switch:	300,000 operating cycles	
Key selector switch:	50,000 operating cycles 30,000 operating cycles including removal of the key	
Safety parameter B_{10D} :	130,000 (emergency stop button)	

Actuating force

Spring-return button:	min. 4 N	max. 100 N
Emergency stop button:	min. 20 N	max. 100 N
Selector switch:	min. 0.1 Nm	max. 1.5 Nm
Key selector switch:	min. 0.1 Nm	max. 1.3 Nm

Contact blocks of the control devices

Material of the contacts:	silver contacts
Contact type:	Self-cleaning contacts with double interruption

Electrical data:

Thermal current I_{th} :	1 A
Rated insulation voltage U_i :	32 Vac/dc
Rated impulse withstand voltage U_{imp} :	1.5 kV
LED supply voltage:	24 Vdc \pm 15%
LED supply current:	10 mA per LED

Utilization category of the contact block:

Direct current: DC13
U_e (V) 24
I_e (A) 0,55

Signalling contact with spring return:

Direct current: DC13
U_e (V) 24
I_e (mA) 10

In compliance with standards:

IEC 60947-5-1, IEC 60947-5-5, EN ISO 13850

⚠ Installation for safety applications:

Always connect the safety circuit to the **NC contacts** (normally closed contacts) as stated in standard EN 60947-5-1.

Internal connections for versions with connector

M12 connector, 5-pole

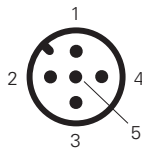

M12 connector, 8-pole

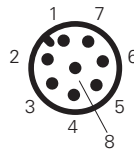

M12 connector, 12-pole

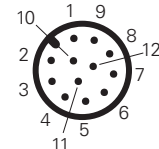

Two M12 connectors, 12-pole

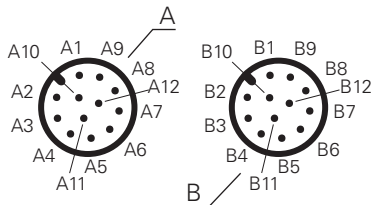

M23 connector, 12-pole

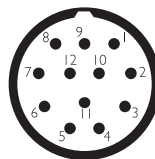

M23 connector, 19-pole

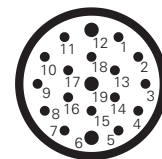

Internal connections for versions with cable

5 poles

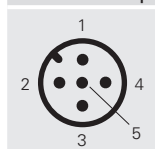

Cable
5x0.34 mm²

8 poles

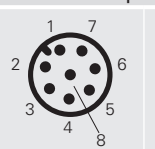

Cable
8x0.25 mm²

12 poles

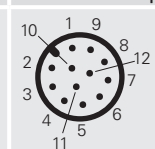

Cable
12x0.14 mm²

Pin	Wire colour	Pin	Wire colour	Pin	Wire colour
1	Brown	1	White	1	Brown
2	White	2	Brown	2	Blue
3	Blue	3	Green	3	White
4	Black	4	Yellow	4	Green
5	Grey	5	Grey	5	Pink
		6	Pink	6	Yellow
		7	Blue	7	Black
		8	Red	8	Grey
				9	Red
				10	Purple
				11	Grey-Pink
				12	Red-Blue

Lenses for VN NG-AC series buttons

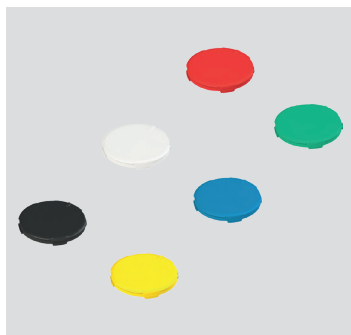

Lenses without engraving			
Article	Description	Colours	Pieces/package
VN NG-AC01	Lens for flush button, black, without engraving	●	10
VN NG-AC02	Lens for flush button, white, without engraving	○	10
VN NG-AC03	Lens for flush button, red, without engraving	●	10
VN NG-AC04	Lens for flush button, green, without engraving	●	10
VN NG-AC05	Lens for flush button, yellow, without engraving	●	10
VN NG-AC06	Lens for flush button, blue, without engraving	●	10
VN NG-ACA0	6 lenses for flush button without engraving, colours: black, white, red, green, yellow and blue	●●●●●●	1

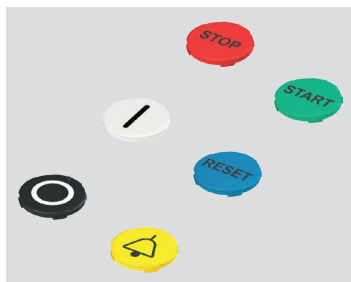

Lenses with engraving			
Article	Description	Colours	Pieces/package
VN NG-AC01-●●●●	Lens for flush button, black, with engraving	●	1
VN NG-AC02-●●●●	Lens for flush button, white, with engraving	○	1
VN NG-AC03-●●●●	Lens for flush button, red, with engraving	●	1
VN NG-AC04-●●●●	Lens for flush button, green, with engraving	●	1
VN NG-AC05-●●●●	Lens for flush button, yellow, with engraving	●	1
VN NG-AC06-●●●●	Lens for flush button, blue, with engraving	●	1

The black lens cannot be used with illuminated buttons.

For ordering lenses for buttons with marking: replace the dots ●●●● in the article codes with the marking code indicated in the tables on pp. 165-168 of the General Catalogue HMI 2023-2024. Example: white lens for flush button with "O" engraving. VN NG-AC02-●●●● → VN NG-AC02-L1

How to replace lenses on buttons

The buttons in the BN series control device units feature replaceable lenses. When replacing the lens on a button, work must be performed with care to avoid irreversibly damaging the button. It is therefore recommended to carefully follow the sequence of steps described below for replacing the button lenses, and to avoid applying excessive force:

- 1 Locate one of the four slots on the lens.
- 2 Insert a small flathead screwdriver or cutter into one of the slots and gently pry off the old lens. Be careful not to scratch or damage the button during this step.
- 3 Position the new lens parallel to the button, using the reference notch on the button to align the lens correctly. For proper lens installation, make sure the reference notch faces upwards, as shown in the figure, or turn the lens in 90° steps with respect to the vertical axis. If the notch is not positioned correctly, the lens will not fit into the button and could be damaged.
- 4 Press down lightly and evenly on the lens until you hear a "click" confirming that the lens has snapped into place. Once properly installed, the lens should be perfectly horizontal and slightly raised — about 0.5 mm — above the edge of the button.

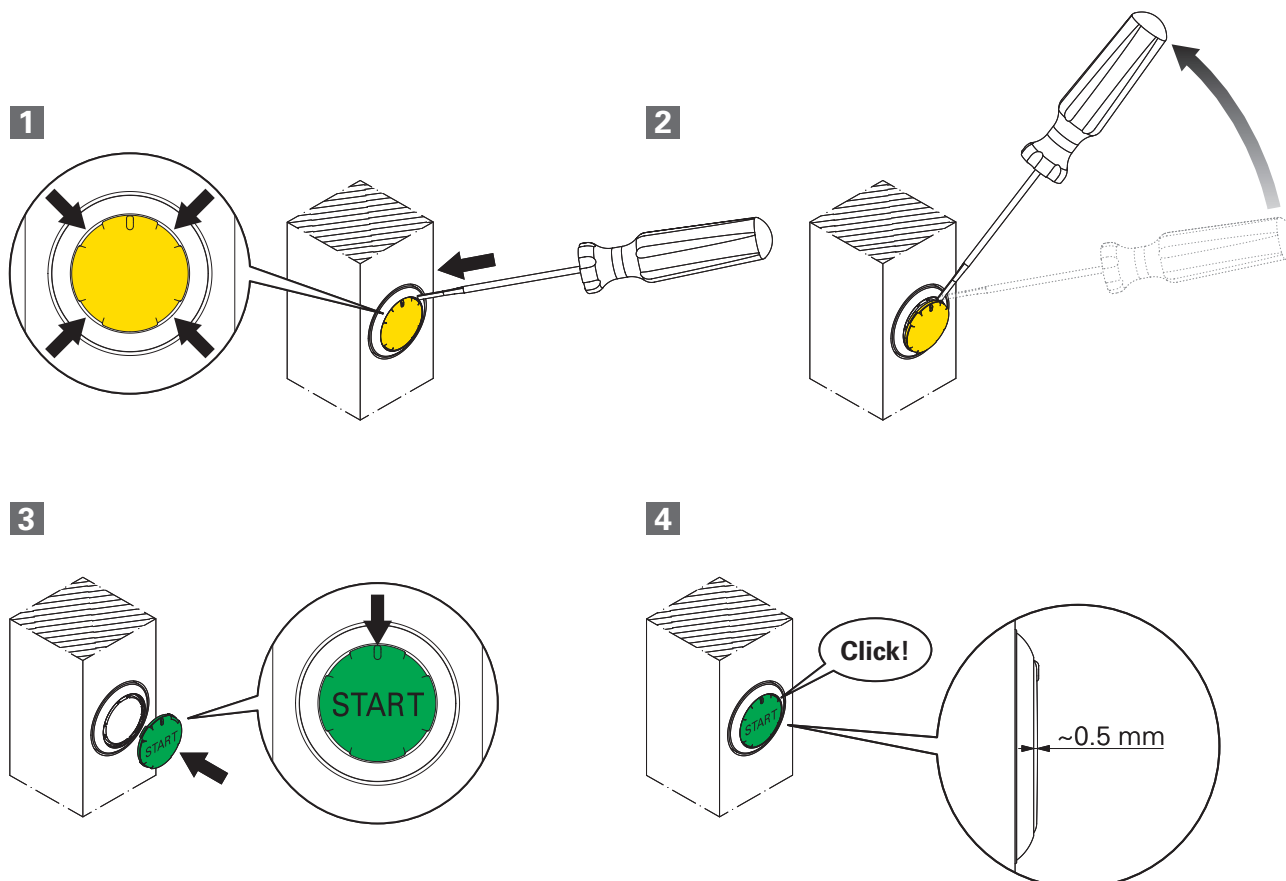



Dimensional drawings

BN AC1●●●●

BN AC2●●●●

BN AC3●●●●

BN AC4●●●●

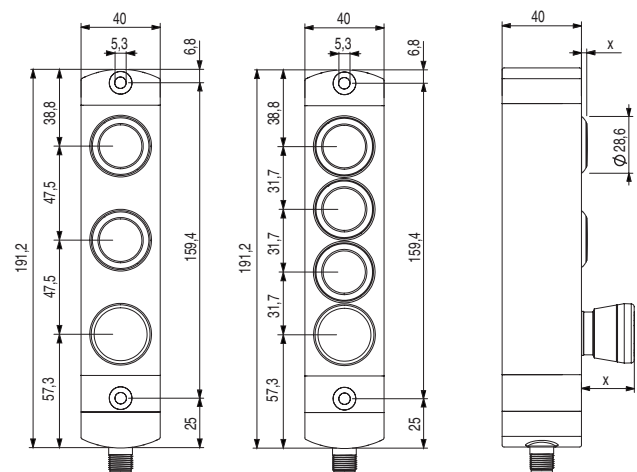
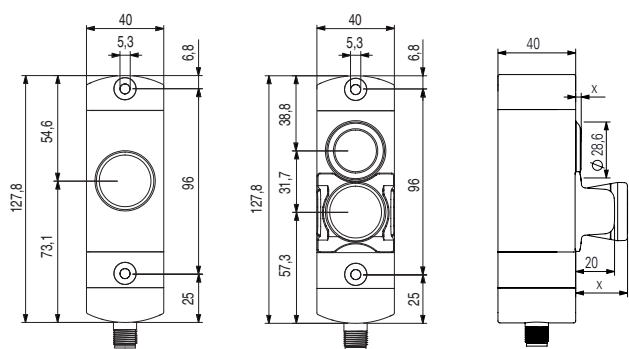

BN AC6●●●●

BN AC7●●●●

BN AC8●●●●

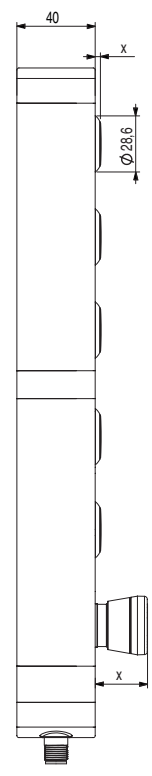
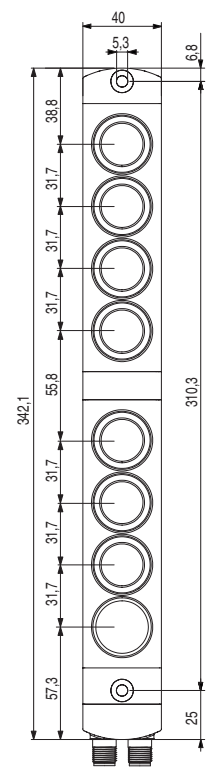
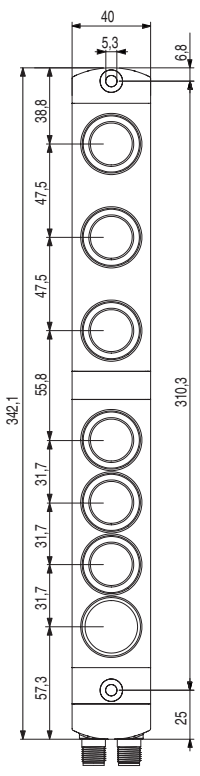
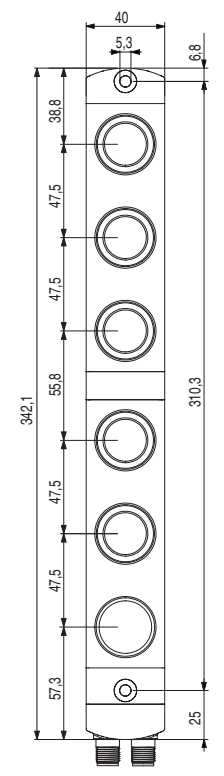

Output type

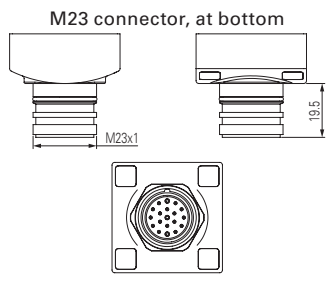
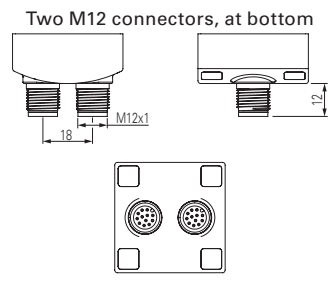
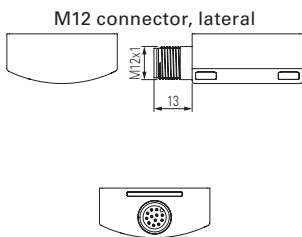
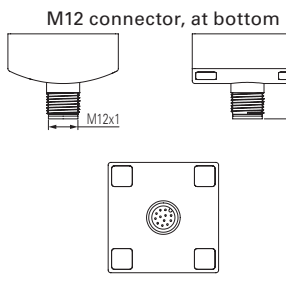

All values in the drawings are in mm

→ The 2D and 3D files are available at www.pizzato.com



General Catalogue
Detection

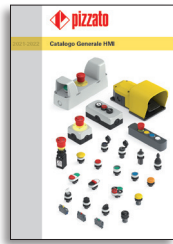

General Catalogue
HMI



General Catalogue
Safety



General Catalogue
Lift



Website
www.pizzato.com



Pizzato Elettrica s.r.l. via Torino, 1 - 36063 Marostica (VI) Italy
Phone: +39 0424 470 930
E-mail: info@pizzato.com
Website: www.pizzato.com

ZE FGL28A24-ENG

