

PRODUCT DATASHEET

PL PFM 625 36 W 4000 K

PANEL PERFORMANCE 625 | Square recessed panel luminaires, tool-free installation, for 625 x 625 mm ceiling system



Areas of application

- Direct replacement for luminaires with fluorescent lamps
- Offices, conference rooms
- Reception areas, foyers, corridors, elevators
- Suitable for recessed ceiling systems with grid size of 625 x 625 mm

Product benefits

- Tool-free electrical connection due to push button connector
- Through-wiring possible with included connector box
- Energy savings thanks to high system efficacy: up to 120 lm/W
- Comfortable light and high color consistency
- Extended services such as energy monitoring and remote maintenance possible with DALI versions
- External driver for extended flexibility and easy installation
- Low flicker light thanks to special electronic control gear
- 5 years guarantee

Product features

- Extruded aluminum frame
- Polystyrene diffuser
- 3-pole terminal block, cable cross section up to 3 x 2.5 mm² (25 W and 30 W versions)
- 5-pole terminal block, cable cross section up to 5 x 2.5 mm² (36 W versions and DALI types)



- Luminaire versions with IoT-ready DALI-2 driver available
- Lifetime (L80/B10): up to 60,000 h (at 25 °C)

TECHNICAL DATA

Electrical data

Nominal wattage	36.00 W
Nominal voltage	220...240 V
Mains frequency	50...60 Hz
Nominal current	160 mA
Inrush current	30 A
Inrush current time T_{h50}	200 μ s
Max. number of luminaires per miniature circuit breaker B16	13
Max. number of luminaires per miniature circuit breaker C10	12
Max. number of luminaires per miniature circuit breaker C16	19
Power factor λ	> 0.95
Total harmonic distortion	< 10 %
Protection class	II
Operating mode	External LED driver

Photometrical data

Luminous flux	4320 lm
Luminous efficacy	120 lm/W
Color temperature	4000 K
Light color (designation)	Cool White
Color rendering index Ra	> 80
Standard deviation of color matching	3 sdc _m
Luminous intensity	-
Low flicker	Yes
Flickering metric (Pst LM)	-
Stroboscope effect metric (SVM)	-
Photobiological safety group acc. to EN62778	RG0
Photobiological safety group acc. to EN62471	RG0
Beam angle	120 °
UGR	< 22



PL PFM 625 36W 4000K LDT

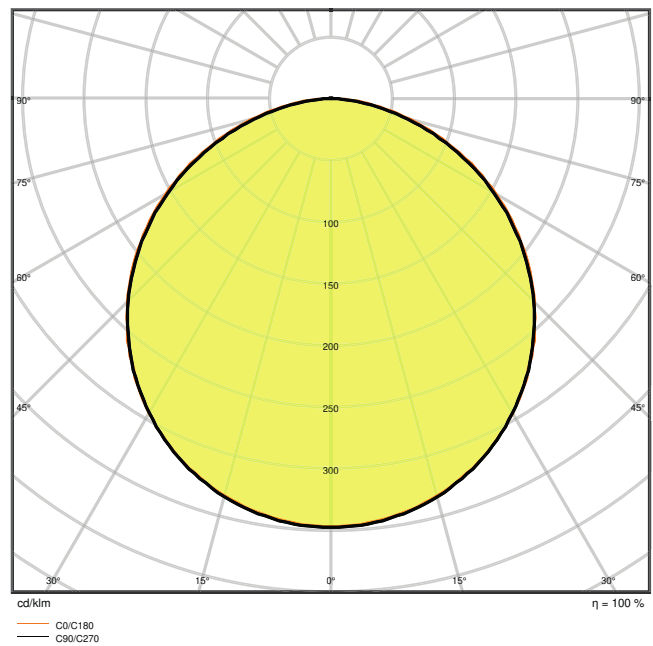

PL PFM 625 36W 4000K LDT

Dimensions & Weight

Length	620.00 mm
Width	620.00 mm
Height	32.00 mm
Product weight	1800.00 g

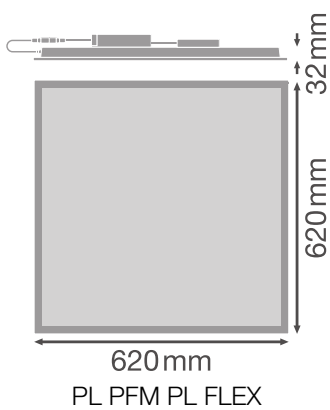

Materials & Colors

Product color	White
Housing color	White
Body material	Steel
Cover material	Polystyrene (PS)
Light emitting surface material	Polystyrene
Glow Wire Test according to IEC 60695-2-12	650 °C
Mercury content	0.0 mg

Application & Mounting

Ambient temperature range	-10...+50 °C
Type of connection	Screwless terminal
Type of protection	IP40/IP20
Protection class IK (shock resistance)	IK02
Dimmable	No
Mounting type	Recessed/Suspended/Surface
Mounting location	Ceiling / Wall
Application environment	Indoor
Mounting length	600,0 mm
Mounting width	600,0 mm
Mounting depth	80,0 mm
With light source	Yes

Lifespan

Lifespan L70/B50 at 25 °C	100000 h ¹⁾
Lifespan L80/B10 at 25 °C	60000 h ¹⁾
Lifespan L80/B50 at 25 °C	60000 h
Lifespan L90/B10 at 25 °C	35000 h
Number of switching cycles	50000

¹⁾ t[h]: L70 / B50 @ 25 °C (Ta), t[h]: L80 / B10 @ 25 °C (Ta), t[h]: L90 / B10 @ 25 °C (Ta)







Control gear

Output current	760 mA
ECG - Output ripple current	< 5 %
Recommended control gear	OSRAM OTI DALI 50/220-240/1A4 NFC

Certificates & Standards

Standards	CE / CB / ENEC / EAC
Luminaire with limited surface temperature, "D sign"	No
Ball shot safe	No
Replaceable light source (EPREL)	Not replaceable







Accessories Optional







Product image	Product name	EAN
	PANEL SECURITY KIT 4x	4058075472990
	PANEL 625 SURFACE MOUNT KIT H70 VAL	4058075402867
	PANEL 625 SURFACE MOUNT KIT H75	4058075472938
	PANEL Suspension Kit	4058075402928
	PANEL 625 RECESSED MOUNT FRAME	4058075402904
	PANEL RECESSED MOUNT CLIPS VAL 4x	4058075409859



EQUIPMENT / ACCESSORIES

- Accessories for several mounting options available
- Connector box with 3-pole or 5-pole terminal included
- Security brackets included
- External control gear included
- Not suitable for use with Emergency Conversion Box

DOWNLOAD DATA

Documents and certificates		Document name
	User instruction / safety instructions	PANEL PFM 600 625
	User instruction / safety instructions	PANEL PERFORMANCE 600/625
	Legal information	Legal insert
	Legal information	LSI PL PFM AND PL PFM DALI
	Legal information	LSI PL PFM AND PL PFM DALI
	Declarations of conformity	PL PFM 600_625

Photometric and lighting design files		Document name
	IES file (IES)	PL PFM 625 36W 4000K
	LDT file (Eulumdat)	PL PFM 625 36W 4000K
	ULD file (DIALux)	PL PFM 625 36W-4000K
	ROLF file (RELUX)	PL PFM 625
	UGR file (UGR table)	PL PFM 625 36W 4000K LDT
	Light distribution curve type cone	PL PFM 625 36W 4000K LDT
	Light distribution curve type polar	PL PFM 625 36W 4000K LDT

CAD/BIM files		Document name
	BIM Revit 3D	PL PFM gen3
	CAD STEP 3D	PL PFM gen3 625

Tender texts		Document name
	Tender documents	PANEL PERFORMANCE 625 36 W 4000 K-EN

LOGISTICAL DATA

Product code	Packaging unit (Pieces/Unit)	Dimensions (length x width x height)	Gross weight	Volume
4058075440692	Folding box 1	52 mm x 647 mm x 719 mm	2320.00 g	24.19 dm ³
4058075440708	Shipping box 4	665 mm x 220 mm x 735 mm	10648.00 g	107.53 dm ³

The mentioned product code describes the smallest quantity unit which can be ordered. One shipping unit can contain one or more single products. When placing an order, for the quantity please enter single or multiples of a shipping unit.

ADDITIONAL CATALOG INFORMATION

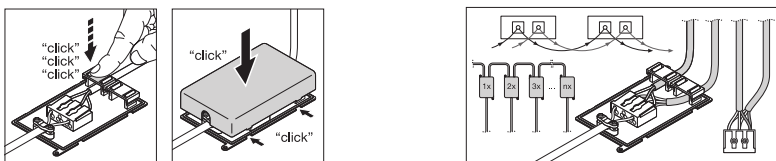

References / Links

– For Guarantee see www.ledvance.com/guarantee

DISCLAIMER

Subject to change without notice. Errors and omission excepted. Always make sure to use the most recent release.