

AI-based defect detection that exceeds the ability of expert inspectors



A better option for inspections requiring high sensitivity

Meeting sensory inspection needs amid a shortage of skilled inspectors

Skilled inspectors are hard to come by these days, and labor costs have risen sharply. Manufacturers are now facing intense pressure to automate processes that rely on the senses of experienced human workers. Particularly when it comes to visual inspection, it's important to reliably identify subtle defects even on flexible lines producing a wide range of items. Traditionally, the sensitivity and knowledge of technicians with long-term experience has been key. However, artificial intelligence is now reaching the stage where it can recognize object features as well as humans and automatically learn criteria. While a lot of AI solutions faces challenges with large amounts of image data, specialized hardware and engineering expertise, Omron is making great progress in enabling its widespread use.





Barriers to automation

1

Defect detection dependent on human senses

2

Inspection criteria dependent on workers' expertise

3

Shortage of engineers who examine automation

AI reproduces human sensibility and experience

To solve these challenges, Omron developed new defect detection AI that reproduces the techniques of skilled inspectors. This AI is now part of the FH Vision System.



AI captures defects with human-like sensitivity

AI identifies good products as well as experienced inspectors

No special environment is required

AI captures defects with human-like sensitivity

Defect detection tasks that rely on human sensibility are a challenge to automate. Fortunately, powerful new AI technology can match the skills and capabilities of experienced inspectors.



Automating human vision-based inspection with the FH Series

The latest capabilities of the FH Vision System include a new AI-based image filter that reproduces the technique that skilled inspectors use to identify a defect on any product background. Scratches and blemishes that were once difficult to capture can now be identified even without the use of samples or adjustment.

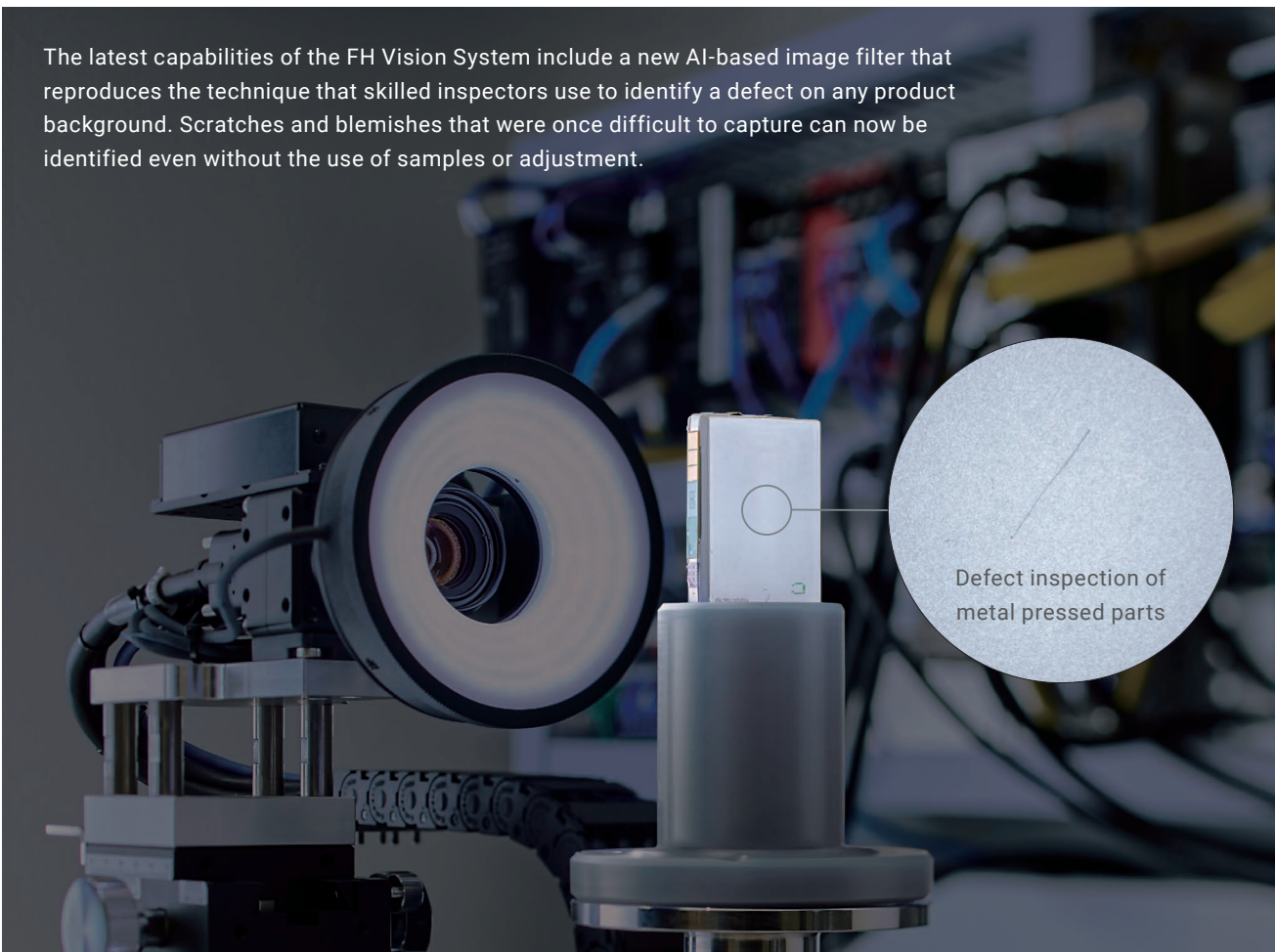

Defect inspection of metal pressed parts



Captured image

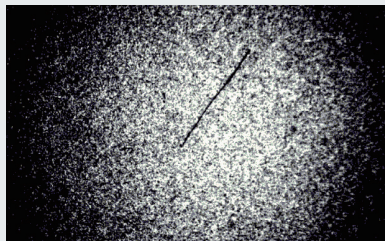

Previous detection image
Cannot separate a scratch from noise



Detection image
Can detect a scratch only

AI

AI reproduces human expertise through learned criteria

AI Scratch Detect Filter *1

The AI Scratch Defect Filter learns by means of images in which human inspectors noticed defects. Whereas previous inspection methods found the unexpected size, shape or color of a particular defect to be a barrier to automation, AI successfully extracts abnormalities by judging their features without definition. The learned data facilitates defect detection on processed surfaces and other uneven backgrounds that previously posed an insurmountable challenge.

Captured image



Extracted scratch (internal image)

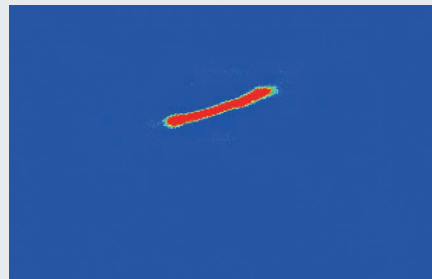

*1. The FH-UMAI1 Scratch Detect AI Software Installer is required to use AI Scratch Detect Filter.

Automatic detection of various defects without definition and learning

Regardless of material type, color, or size, defects can be extracted reliably without previously required definition and adjustment.

Scratch on sandblasted metal

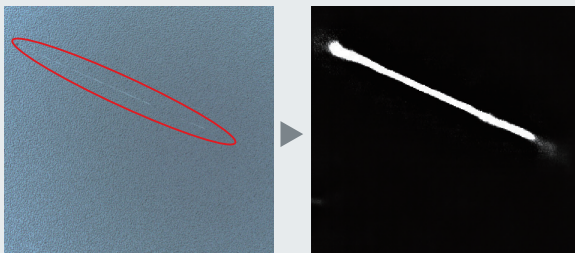

Scratch on resin products



Black scratch on hairline finish

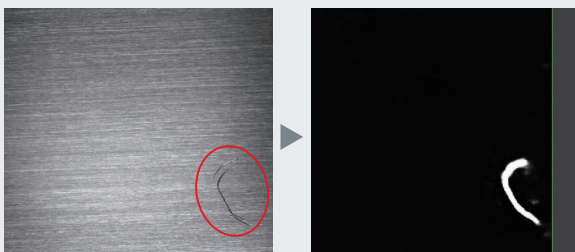

White scratch on shaded hairline finish

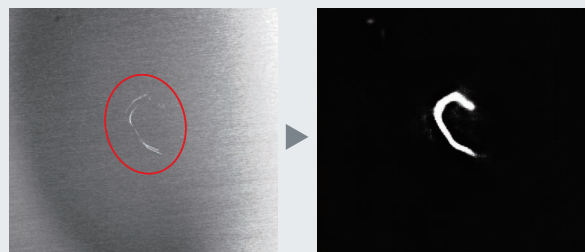

AI identifies good products as well as experienced inspectors

Sensory inspection requires a certain tolerance for variations that don't pass a certain threshold. Determining what variations are acceptable is a key capability of expert inspectors and poses a challenge for automated inspection systems.



The FH Series can determine acceptable variation tolerances.

Omron's AI Fine Matching tool learns from the image data of non-defective products to quickly acquire the "expertise" that inspectors develop over the course of many years. This reduces costs and boosts productivity through automation.

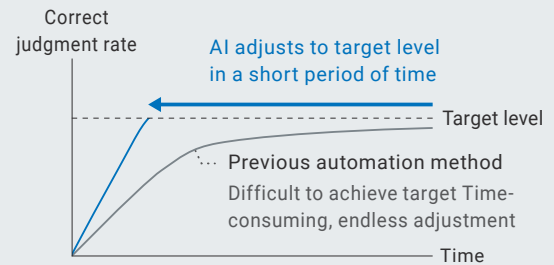

Target inspection level: Reduce over-detection

		Difference image	
		Previous automation method	AI automation method
Contamination inspection of LED modules	Captured image	Detects position differences, not foreign materials, as defects	Detects foreign materials only and ignores position differences
Defective product With foreign materials		 Overdetection	 Detects foreign material only
Non-defective product Position difference of die		 Overdetection	 Judges as non-defective product
Non-defective product Position difference and light variation of surrounding part		 Overdetection	 Judges as non-defective product

AI reduces overdetection

AI Fine Matching

AI Fine Matching identifies a feature that is not included in good products as a defect.

AI learns images of good products with variations, and generates an AI model.

Every time an inspection is carried out, AI reconstructs a model that is presumed to be a good product.

AI extracts a difference between the reconstructed good product image and a captured image to identify a defect, reducing overdetection.

Captured image



Shifted to upper right



Shifted to lower left

AI model

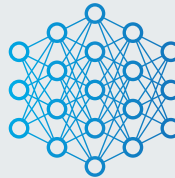

Reconstructed good product image

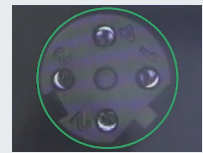

Reconstructs a good product image considering different views of holes

AI makes it easy to avoid overdetection

PATENT PENDING *1

Three quick steps on the settings screen guide the user through the process of creating the good product model with the minimum number of images.

1 Prepare images

Although standard AI processing requires a huge number of images for learning, the FH Series requires only 100 to 200 images.

Good product image



Defective product image



2 Create model

The system suggests images to learn, helping to complete the good product model.

AI makes it easy



AI model

3 Check results

Test is automatically performed using images prepared in Step 1. You don't need to adjust parameters for differential inspections.

AI makes it easy



Correlation score
Image A:10
Image B:150
...

When a good product is judged as defective, AI gives each image a correlation score to visualize the degree of overdetection. This facilitates selecting images that need to be learned to reduce overdetection.

*1. "Patent pending" means that we applied for a patent in Japan, and "Patented" means that we obtained a patent in Japan. (as of May 2020)

No special environment is required

With the FH Series, there's no need for high-end hardware or specialized engineers who can configure the system to suit your needs. Our general-purpose vision system makes it easier than ever to introduce AI into production sites.

Vision controller with AI functionality

Artificial intelligence has traditionally required a high-end environment, but our lightweight creative solution comes in the form of user-friendly processing items that have been integrated into our popular FH Series hardware.

No special hardware for AI required

It used to be difficult to introduce AI technology to many inspection processes because of its hardware requirements. The FH Series does not require special hardware, facilitating the introduction of this technology. The FH Series does not require special hardware, facilitating introduction.

No AI engineer required

In order to reliably use AI technology in processes, the engineer used to have not only image processing skills but also programming and maintenance skills. With the FH Series, however, you can use AI technology just like operating a standard vision sensor. No dedicated AI engineer is required.

FH-5550/5050
High-speed,
Large-capacity Controller
with AI



Intel® Core™ i7 processor



Outstanding processing speed

Ultra-high-speed CPU



4 times faster*1 than our previous models

Large-capacity RAM

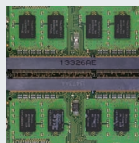

10 times larger*1 than our previous models

- 1 Machine control network Cycle: 125 μs

EtherCAT

- 2 Data output High-speed interface: USB 3.0

*1. The FH-5550 Controller is compared with the FH-3050 Controller.

High-resolution cameras

We offer a range of cameras that can capture high-resolution images suitable for sensory inspection at high speeds.



Ultra-high-speed sensing technology in a compact design

There was a trade-off between high-resolution image capture like the human eye and inspection processing speed. We use new CMOS image elements and dual transfer technology to capture high-resolution images while transferring images at high speeds. This facilitates applications that previously required multiple cameras or a mechanism to move a camera.

MDMC light with flexible lighting patterns

This light can be adjusted to defects by combining the illumination colors and angles like humans do. Even if new objects or inspection items are added after installation, there is no need to add or change the light—just change the illumination pattern. The illumination patterns can be registered as settings, facilitating duplicating production lines.

Illumination structure

You can choose the best pattern by combining illumination directions x full color RGB x 128 brightness levels of 13 blocks.

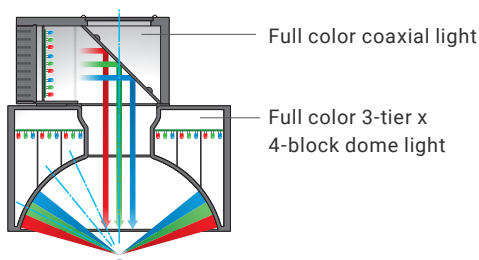

*2. MDMC...Multi-Direction Multi-Color

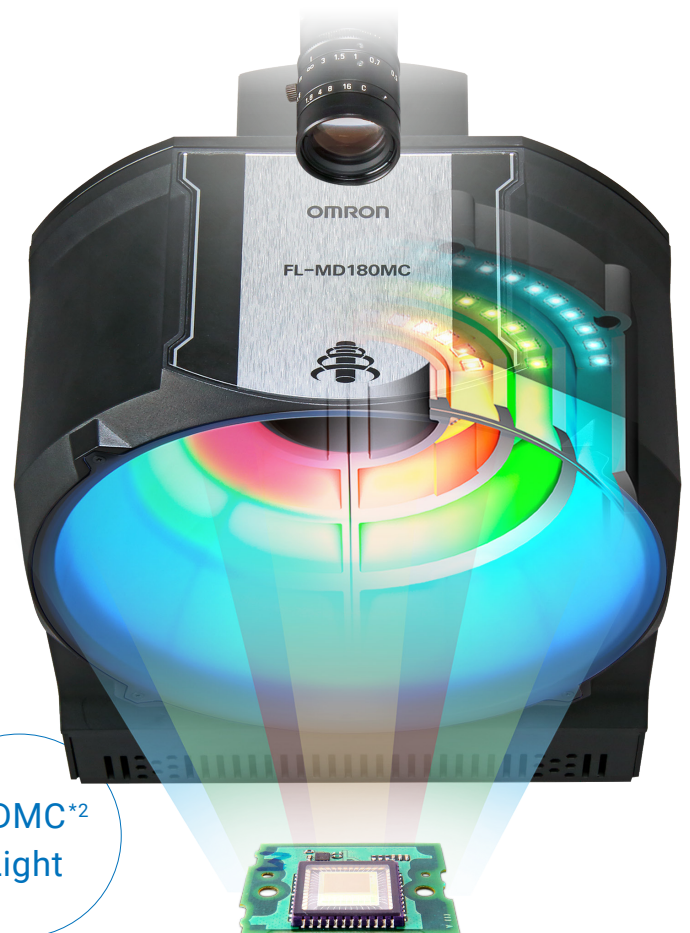

Software for flexible automation

Flexible image capture



Multi-Trigger Imaging captures long objects at high speeds

The Multi-Trigger Imaging function can capture images and process them in parallel, leveraging the speed of the multi-core processor to capture long objects at high speeds.

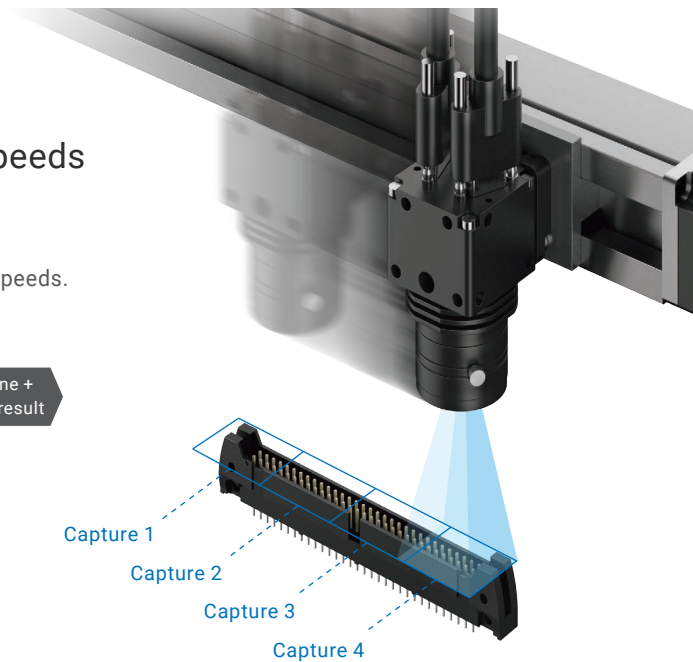
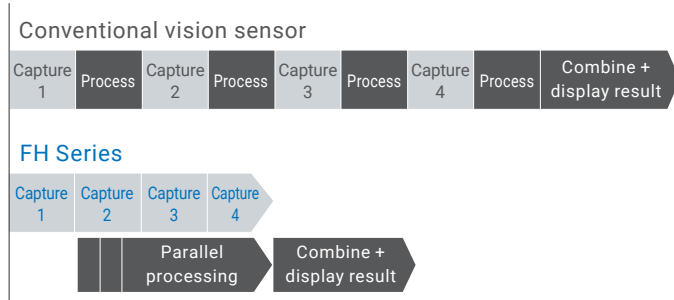

Camera Image Input HDR optimizes contrast

Camera Image Input HDR helps create optimized HDR images under variable ambient conditions. Once you specify the optimum area to capture on the image, the FH Series automatically adjusts the shutter speed while capturing images and combining the images.

Adjusts brightness to suit your specified area

Optimized for the entire field of view

While the contrast around the pins is low, reduced reflection enables capturing a clear image of the entire connector.

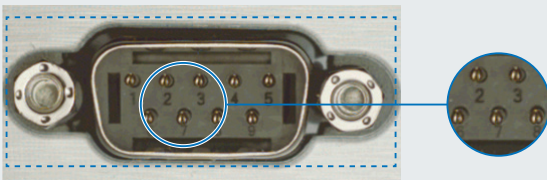

Optimized for the connector

Although reflection occurs at the surrounding part, a clear image of the pins can be captured.

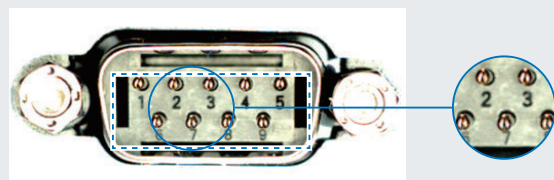

Detects low-contrast defects in high-contrast mode

Previously

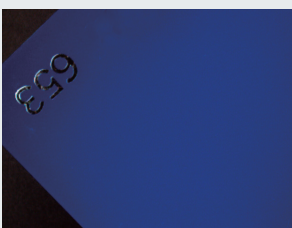

Low contrast makes the surface appear uniform.

HDR high-contrast image

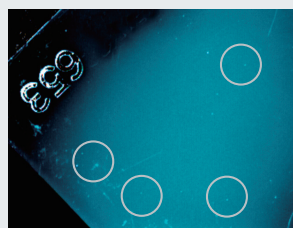

Increased contrast reveals many scratches and blemishes.

Parallel processing for different inspections

Multi-Line Random-Trigger inspects at up to four different timings

A single controller can perform inspections at different points at different timings. Controllers installed for each process can be integrated into one, reducing initial costs and saving space.

Packaging process of pharmaceuticals

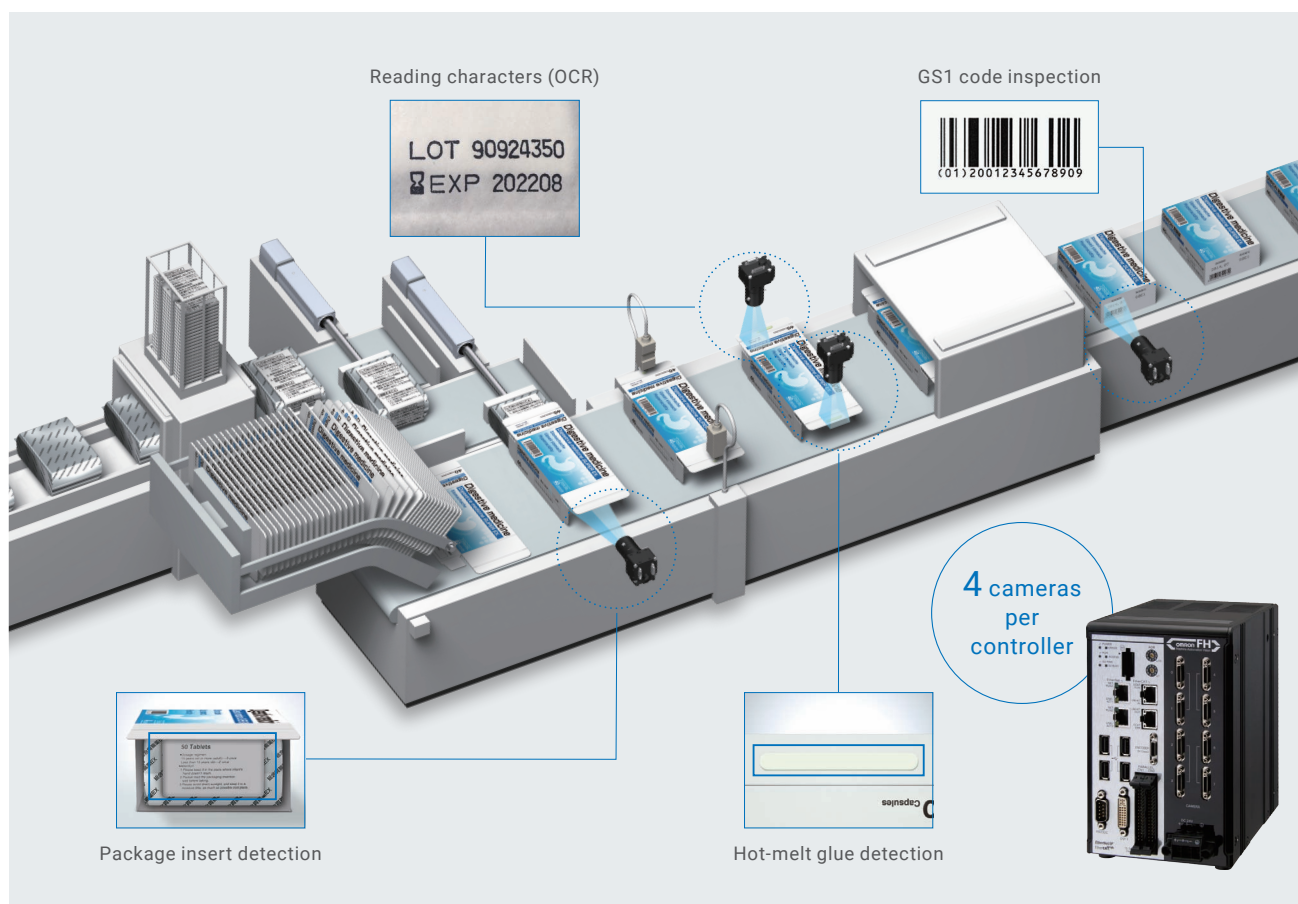

Contamination inspection of beverage containers

A single controller that can control each line saves initial costs and space.

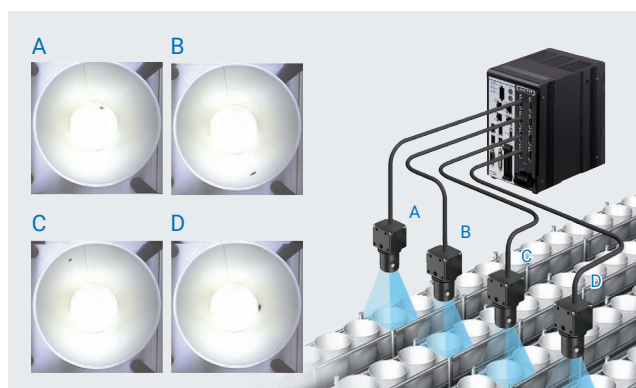

Appearance inspection of rechargeable battery cells

Four cameras can be connected to one controller, enabling simultaneous inspection of dents and scratches from four directions.

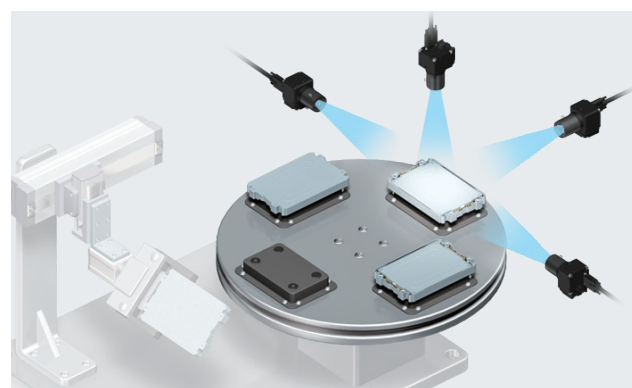

High-speed, high-precision positioning



Shape Search III is robust against shape variations

High-precision and robust positioning is possible even under the adverse conditions, such as changes in environments and materials.

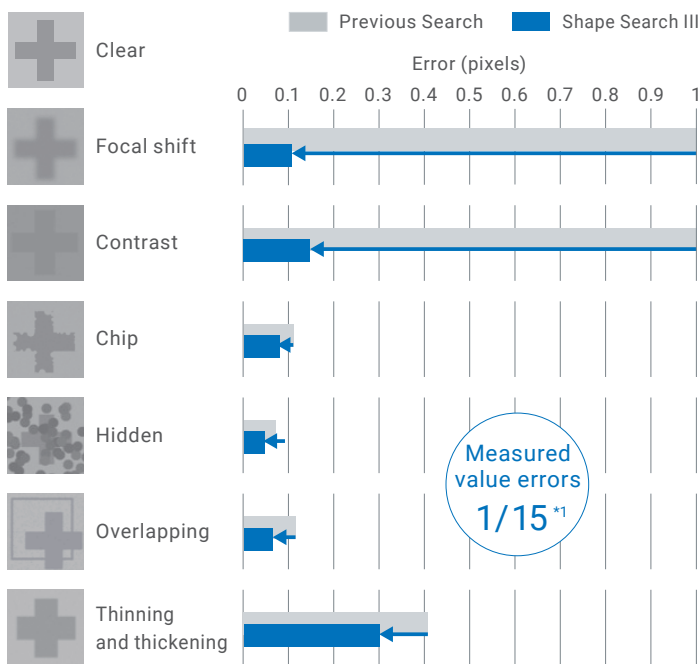

A 20.4 Mpix camera can search a positioning mark in as fast as 12 ms*2, and a 5 Mpix camera, widely used for alignment applications, in as fast as 2 ms.

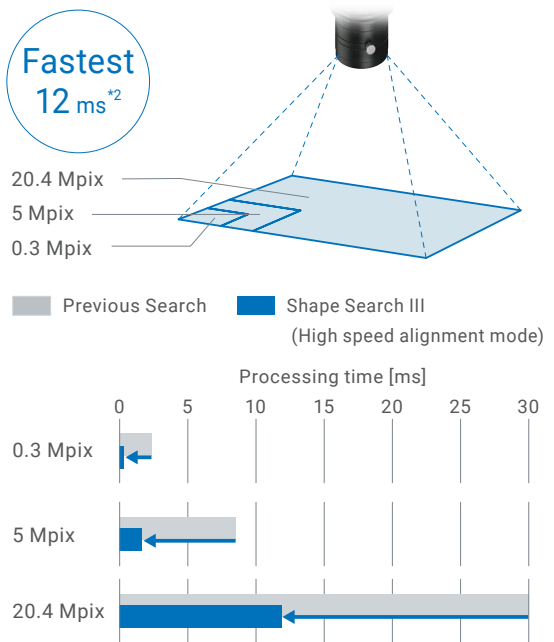

*1. The value measured under our specified conditions is provided for reference. *2. The value measured under our specified conditions is provided for reference. 20.4 Mpix camera.



Circular Scan Edge Position accurately estimates the center and radius of a circle

The new algorithm accurately detects a whole circle from a part of the circle.

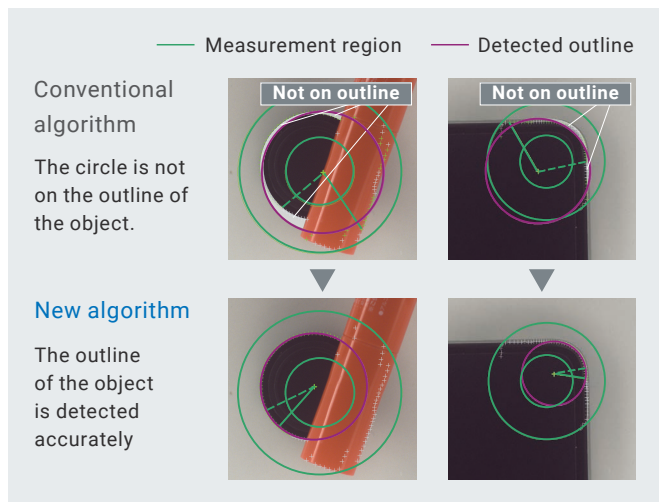

Scan Edge Position removes noise to detect edges

This algorithm accurately estimates lines even when the edges are unclear due to variations in objects or disturbance.

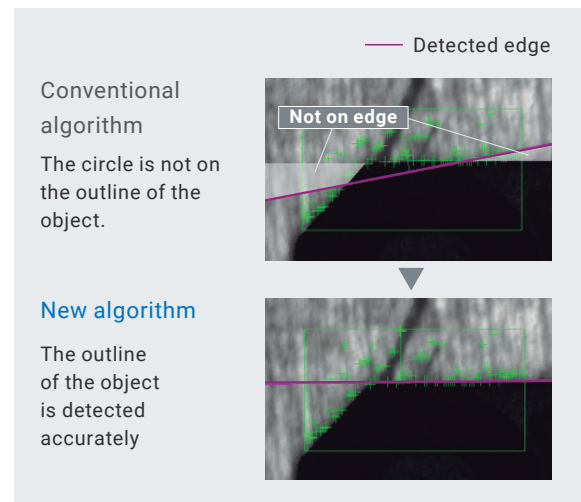



Stage Data calculates for various stages

The popular single axis + θ axis stages as well as UVW stages can be used. The use of the same axis for both handling and positioning simplifies machine configuration.

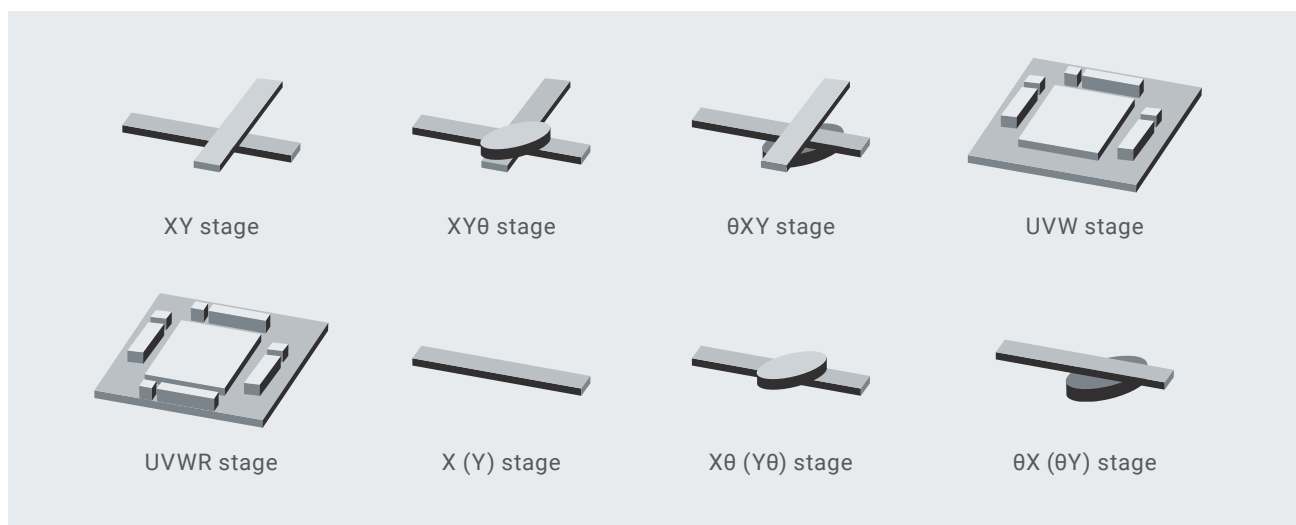

Robot Setting Tool simplifies connecting robots

Communication programs to connect robots from various vendors and FH flowcharts required for robot applications are provided free of charge. You can quickly set up robot vision applications.

Applications

Pick

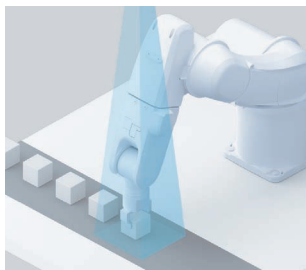

Offset compensation

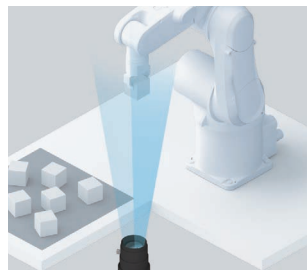

Place

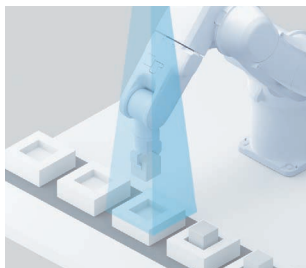

Combination

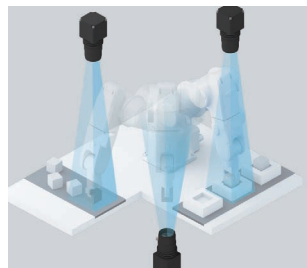

Simple set-up steps

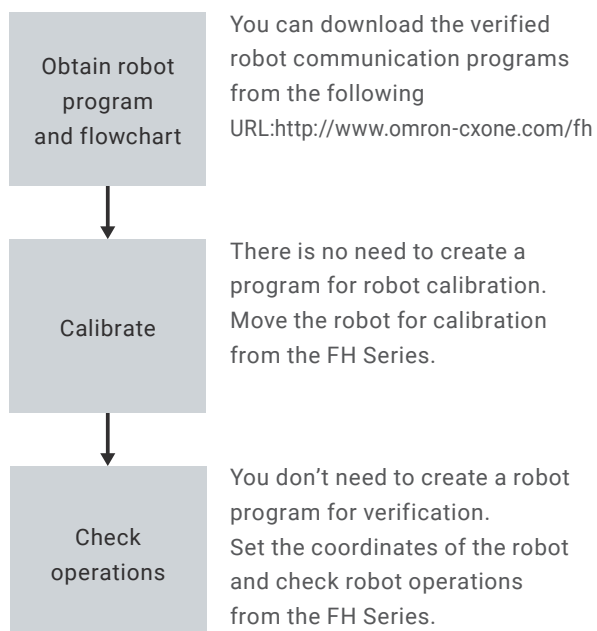

Unique identification and quality control

Unique ID associated with inspection image and result

The FH Series can associate a unique ID with the inspection image and result, and then output them to the host device. You can immediately find required inspection images and quickly identify causes of fails.

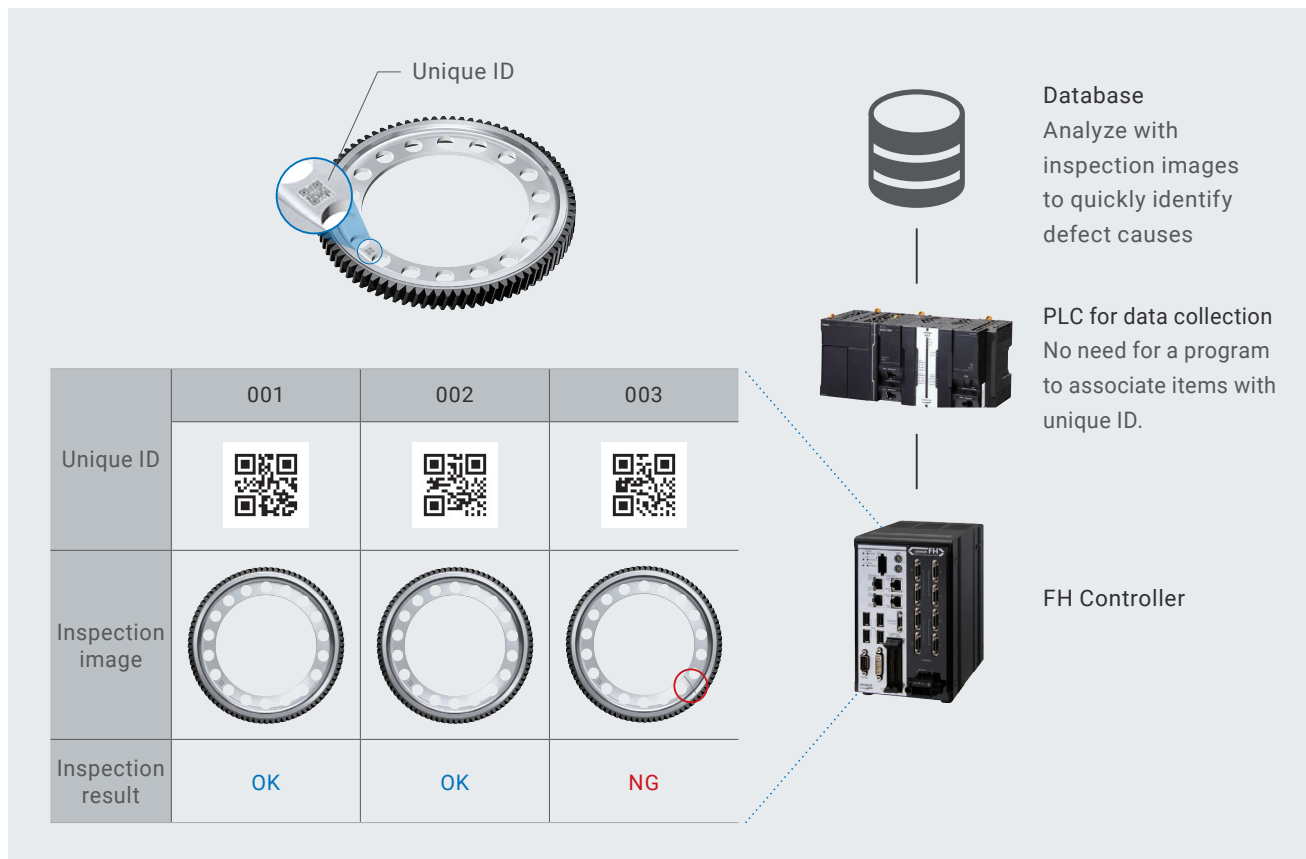

High-speed image storage

The amount of inspection image data required for defect cause analysis can be so large that conventional controllers are unable to store it given their storage time and capacity constraints.

The high-speed, large-capacity controller has USB 3.0 ports and the improved algorithm to compress image data at high speeds, enabling all images to be stored to meet increasing needs in quality control.

The times in the right figure provided for reference only and their accuracy cannot be guaranteed. They are measured under the following conditions:

- FH-5050 Controller
- 5 Mpix monochrome images
- Size of converted JPEG file: 0.6 MB

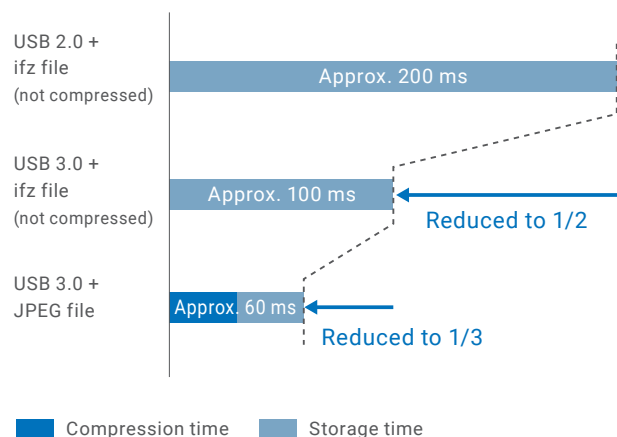



2D Code II provides powerful code reading

Recognition rate
2 times*1

3 times
faster*1

The FH Series incorporates a dedicated algorithm for reliable and fast 2D code reading even under variable ambient brightness or adverse conditions such as after processing or washing.

<p>Changing ambient brightness</p> <p>Chips due to reflection</p> <p>Low contrast</p>	<p>Poor printing quality in high-speed line</p> <p>Variations in start positions</p> <p>Uneven line spacing</p>	<p>After processing or washing</p> <p>Waterdrops and oil stains</p> <p>Scratched damage</p>	<p>Poor printing quality on coarse surface</p> <p>Molding variations of forged object</p> <p>Print Quality Grading Function</p> <ul style="list-style-type: none"> · ISO/IEC 15415 · ISO/IEC TR29158
---	---	---	--

*1. The average value measured under our specified conditions is provided for reference.



OCR reliably reads difficult-to-read characters

OCR can reliably read characters printed too close to each other or on curved surfaces. Also plus signs can be read.

<p>Touching characters</p>	<p>Curved character string including plus sign</p>	<p>Curved character strings</p>
----------------------------	--	---------------------------------

NEW



Character Inspection reads special fonts

Character Inspection recognizes special fonts and non-alphanumeric characters based on pattern search using the dictionary set up by the user.

<p>Special fonts</p>	<p>Japanese characters</p>
----------------------	----------------------------

Design interface for quick setup

Integrated development environment Sysmac Studio

Sysmac Studio is a unique environment that integrates logic, motion and drives, robotics, safety, visualization, and information technologies in a single project, thus reducing the learning curve and the intra-operative software costs.

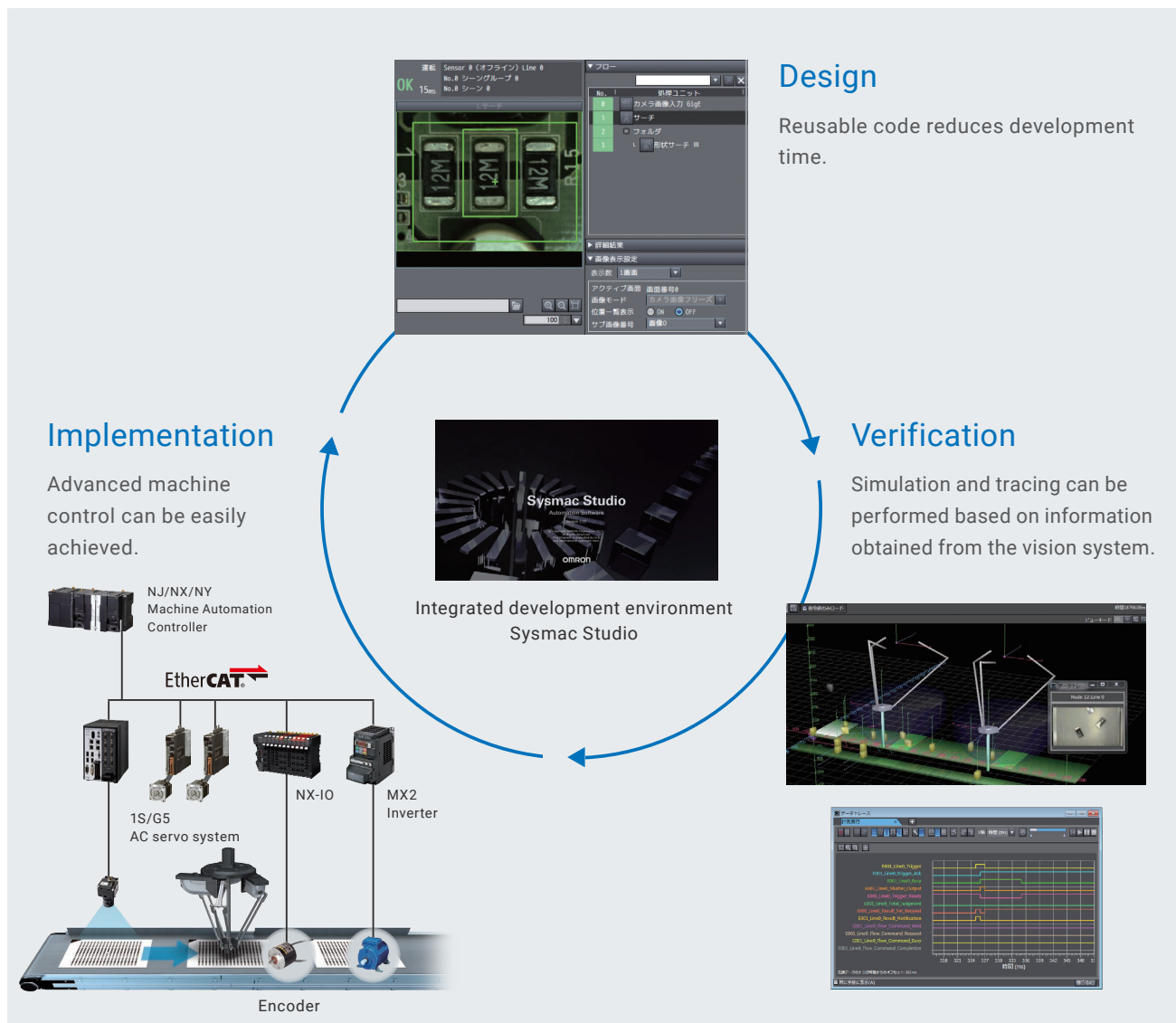

EtherCAT® for high-speed data transfer to control various devices

Data communications cycle: 125 μs

You can use EtherCAT® to connect NJ/NX Machine Automation Controllers and 1S/G5 AC Servo System to increase the control speed of everyday communications protocols from position detection to starting axis motion.

Communications cycle

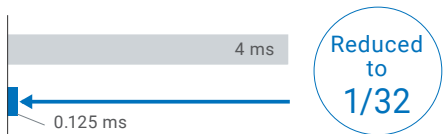

Time from trigger input to producing measurement results

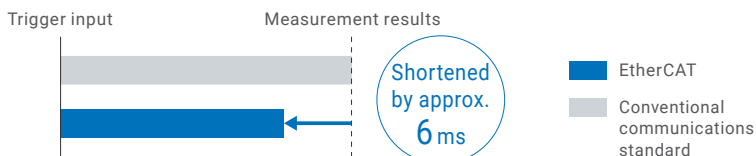

Note: The times given above are typical times. They depend on parameter settings.

Total Design Management Editor simplifies complex processing design

This design interface includes pre-installed screens for all phases, from design through to setting and operation. Just select processing items and determine the order to manage variables. Time-consuming calculations and inputs are no longer required.

Easy setting

All the common settings of multiple scenes can be made at once. Simplified inspection flowcharts reduce setting errors and prevent from forgetting to change settings.

Efficient setting

To inspect aligned parts, the FH Series can repeat the same measurements while shifting the measurement region within the same image. This reduces setting times.

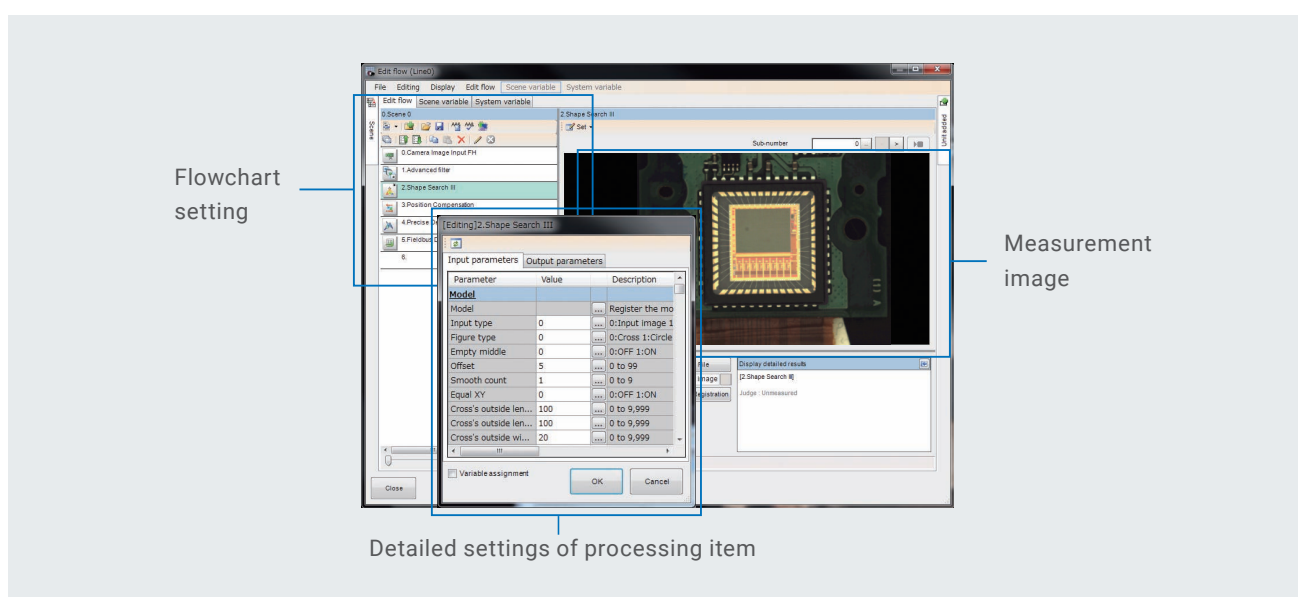

Customizable user interface simplifies operations at production sites

Showing only necessary screens for production makes the interface easier to use. Screen layout can be customized just by selecting and placing objects, without programming.

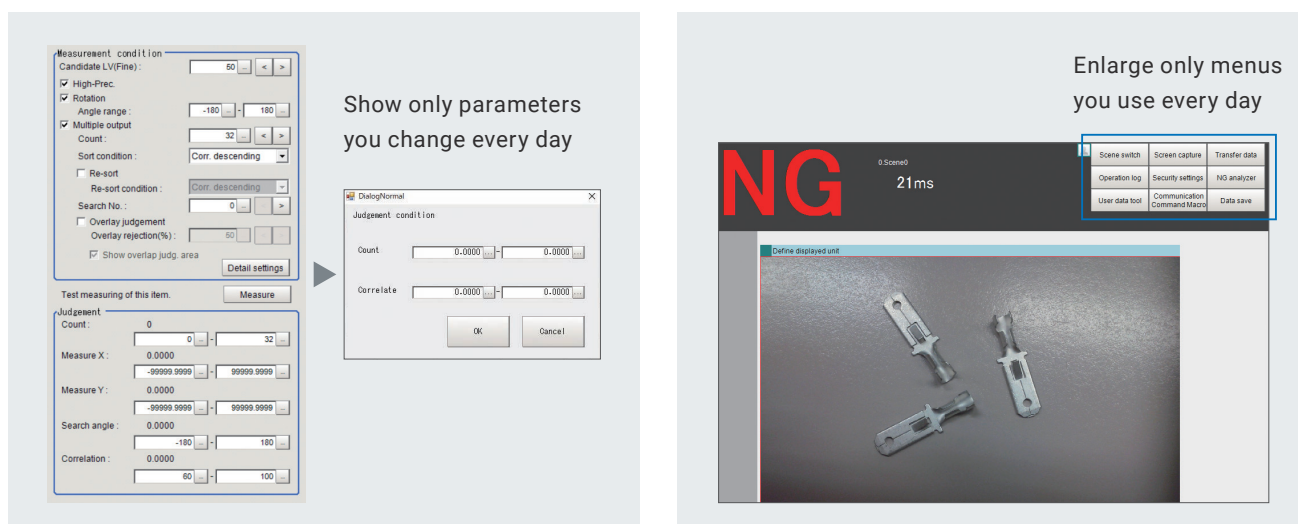

Vision System FH-Series

AI-based automated visual inspection

- AI reproduces human sensibility and experience
- Software for flexible automation
- Design interface for quick setup



System configuration

EtherCAT connections for FH series

Example of the FH Sensor Controllers (4-camera type)

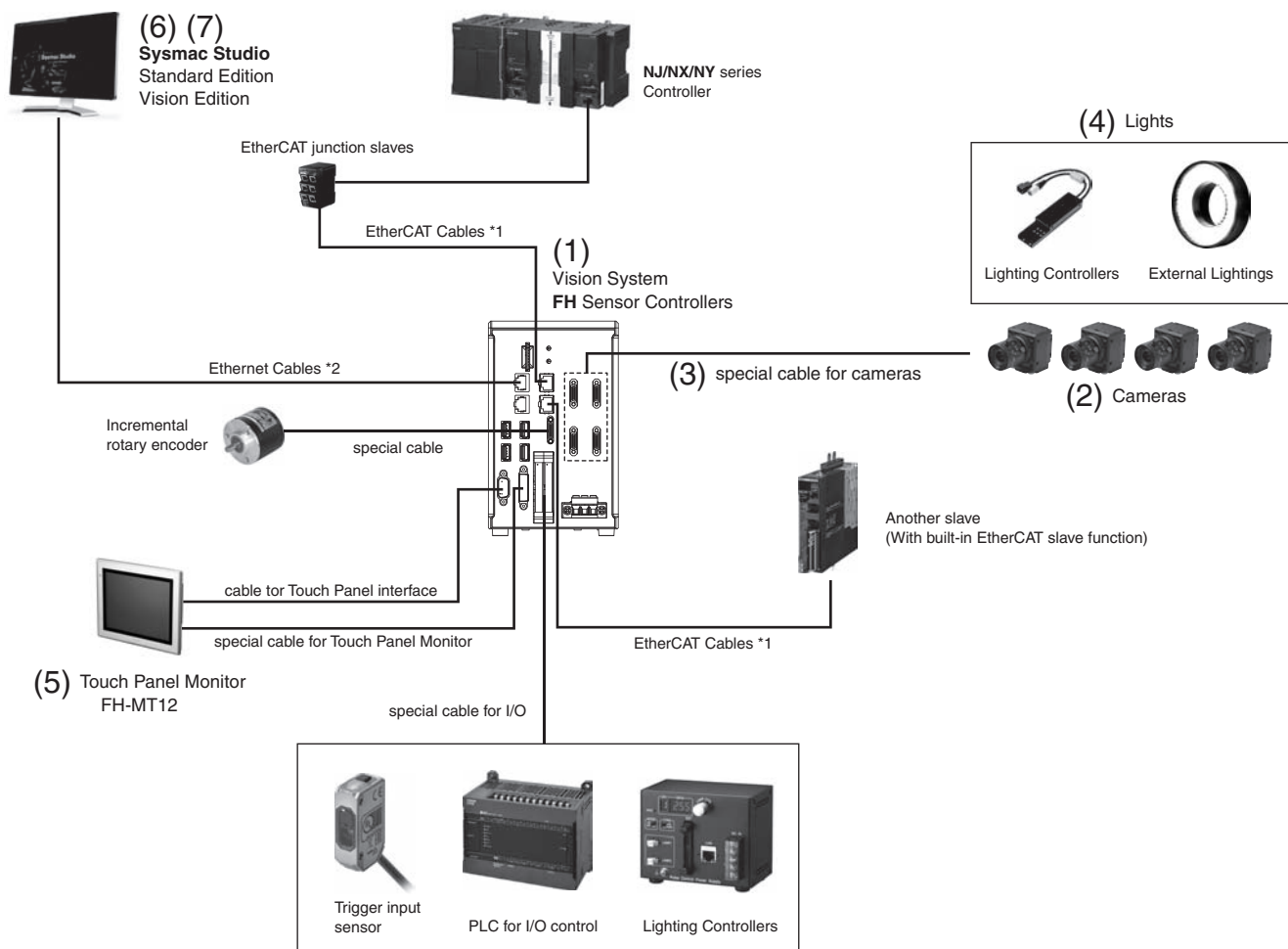

*1. To use STP (shielded twisted-pair) cable of category 5 or higher with double shielding (braiding and aluminum foil tape) for EtherCAT and RJ45 connector.
*2. To use STP (shielded twisted-pair) cable of category 5 or higher for Ethernet and RJ45 connector.



(1) Controllers

Select a controller based on the required processing speed and network.

	Series	CPU	Performance	Memory	No. of connectable cameras	Fieldbus
High-speed, Large-capacity Controller	FH-5550 Series	Intel® Core™ i7 processor 4 cores	★★★★★	RAM 32 GB, ROM 64 GB	8 max.	PROFINET, EtherNet/IP™, EtherCAT
High-speed Controller	FH-5050 Series	Intel® Core™ i7 processor 4 cores	★★★★★	RAM 8 GB, ROM 32 GB	8 max.	PROFINET, EtherNet/IP™, EtherCAT
Standard Controller	FH-2050 Series	Intel® Celeron® processor 2 cores	★★★	RAM 8 GB, ROM 32 GB	8 max.	PROFINET, EtherNet/IP™, EtherCAT
Lite Controller	FH-L550 Series	Intel® Atom® processor 2 cores	★	RAM 4 GB, ROM 4 GB	4 max.	PROFINET, EtherNet/IP™

★: The more stars, the higher the performance.

Optional product (sold separately)	Model
Scratch Detect AI Software Installer*	FH-UAI1

* This product can be installed on the FH-500-series Controller (version 6.40 or later).

(2) Cameras

Choose the right camera to suit your required number of pixels. Easy-to-use cameras with built-in light are also available.



No. of pixels	High-speed camera	Standard camera	Rolling shutter camera	Camera with built-in light
20.4 Mpix*	---	---	FH-S□21R	---
12 Mpix	FH-S□X12	---	---	---
5 Mpix	FH-S□X05	FZ-S□5M3	FH-S□05R	---
2 Mpix	FH-S□02	FZ-S□2M	---	---
0.4 Mpix/0.3 Mpix	FH-S□X	FZ-S□	---	FZ-SQ□□□□

* 20.4 Mpix Cameras can be used with the FH-5050/2050-series High-speed, Large-capacity Controllers.

(4) Lights

Omron offers a complete line-up of lights required for image processing. The use of the camera-mount lighting controller allows you to control lighting conditions from the FH Controller, making system configuration simple.



External lighting controller

Description	LED	High-brightness LED
Camera-mount Lighting Controller	FLV-TCC	FL-TCC
Bar Light	FLV-BR	FL-BR
Direct Ring Light	FLV-DR	FL-DR
Low Angle Ring Light	FLV-DL	---
Coaxial Light	FLV-CL	---
Shadowless Light	FLV-FR/FP/FS/FQ	---
Spot Light	FLV-EP	---
Direct Back/Edge Type Light	FLV-DB/FB	---
Dome Light	FLV-DD	---
Photometric Stereo Light *	---	FL-PS

* The FL-TCC Camera-mount Lighting Controller cannot be used. Use the FL-TCC1PS Lighting Controller for Photometric Stereo Light.

Built-in lighting controller

Description	Model
MDMC Light	FL-MD

Refer to the Vision Accessory Catalog (Cat. No. Q198) for details.

(5) Touch panel monitor

The touch panel monitor is optimized for the operation of the FH Series.



Description	Model
Touch Panel Monitor 12.1 inches	FH-MT12
DVI-Analog Conversion Cable for Touch Panel Monitor	FH-VMDA □□
USB Cable for Touch Panel Monitor	FH-VUAB □□

* RS-232C cables for long-distance connections are also available. Refer to Ordering Information for details.

(3) Camera cables

The cable line-up includes bend-resistant cables and right-angle cables. Use the FZ-VSJ Cable Extension Unit for cable extensions.



Description	Model
Camera Cable	FZ-VS□ □□M
Right-angle Camera Cable	FZ-VSL□ □□M
Bend-resistant Camera Cable	FZ-VSB3 □□M
Bend-resistant Right-angle Camera Cable	FZ-VSLB3 □□M
Cable Extension Unit	FZ-VSJ

(6) Sysmac Studio

The development environment for the Sysmac platform allows you to configure and simulate the FH Series on your PC.



Description	Model
DVD for installation	SYSMAC-SE200D
Software license (Vision Edition)	SYSMAC-VE001L

(7) Application producer

This development environment enables you to customize FH functions. It includes sample codes and wizards that will help you develop your own interfaces and processing items.





Description	Model
DVD for installation	FH-AP1
Software license	FH-AP1L

FH-Series

Ordering Information

FH Series Sensor Controllers

Item	CPU	AI function		No. of cameras	Output	Model	
		AI Scratch Detect Filter*	AI FineMatching				
	High-speed, Large-capacity Controller	Intel® Core™ i7 processor 4 cores	Available	Available	2	NPN/PNP	FH-5550
					4	NPN/PNP	FH-5550-10
					8	NPN/PNP	FH-5550-20
	High-speed Controller	Intel® Core™ i7 processor 4 cores	Available	Available	2	NPN/PNP	FH-5050
					4	NPN/PNP	FH-5050-10
					8	NPN/PNP	FH-5050-20
	Standard Controller	Intel® Celeron® processor 2 cores	Not available	Available	2	NPN/PNP	FH-2050
					4	NPN/PNP	FH-2050-10
					8	NPN/PNP	FH-2050-20
	Box-type controllers	Intel® Atom® processor 2 cores	Not available	Not available	2	NPN/PNP	FH-L550
					4	NPN/PNP	FH-L550-10









* Optional FH-UMA11 Scratch Detect AI Software Installer is required.

Optional Products (Sold Separately)

Item	Model
Scratch Detect AI Software Installer *	FH-UMA11

* This product can be installed on the FH-5□50-series Controller (version 6.40 or later).

Cameras

Item	Lens mount	Descriptions	Color / Monochrome	Image Acquisition Time *1	Model
	C mount	20.4 million pixels (Supported controller: FH-5□50(-□)/2050(-□) Series) *2	Color	42.6 ms *3	FH-SC21R
			Monochrome		FH-SM21R
	C mount	12 million pixels *2	Color	24.9 ms *3	FH-SCX12
			Monochrome		FH-SMX12
		5 million pixels	Color	10.3 ms *3	FH-SCX05
			Monochrome		FH-SMX05
		0.4 million pixels	Color	1.9ms	FH-SCX
			Monochrome		FH-SMX
	M42 mount	12 million pixels *2	Color	25.7 ms *3	FH-SC12
			Monochrome		FH-SM12
	C mount	4 million pixels	Color	8.5 ms *3	FH-SC04
			Monochrome		FH-SM04
		2 million pixels	Color	4.6 ms *3	FH-SC02
			Monochrome		FH-SM02
		0.3 million pixels	Color	3.3 ms	FH-SC
			Monochrome		FH-SM
	C mount	5 million pixels	Color	71.7ms	FH-SC05R
			Monochrome		FH-SM05R
	C mount	5 million pixels	Color	38.2 ms	FZ-SC5M3
			Monochrome		FZ-S5M3
	C mount	2 million pixels	Color	33.3 ms	FZ-SC2M
			Monochrome		FZ-S2M
		0.3 million pixels	Color	12.5 ms	FZ-SC
			Monochrome		FZ-S
	Lenses for small camera required	300,000-pixel flat type	Color	12.5 ms	FZ-SFC
			Monochrome		FZ-SF
		300,000-pixel pen type	Color	12.5 ms	FZ-SPC
			Monochrome		FZ-SP

Item		Lens mount	Descriptions	Color / Monochrome	Image Acquisition Time *1	Model
	Intelligent Compact Digital CMOS Camera	Built-in lens	Narrow view	Color	16.7 ms	FZ-SQ010F
			Standard view	Color		FZ-SQ050F
			Wide View (long-distance)	Color		FZ-SQ100F
			Wide View (short-distance)	Color		FZ-SQ100N

*1 The image acquisition time does not include the image conversion processing time of the sensor controller.

The camera image input time varies depending on the sensor controller model, number of cameras, and camera settings. Check before you use the camera.

*2 Up to four cameras of this model can be connected to one controller. Up to eight cameras including other models can be connected to an FH-5550-20, 5050-20 or 2050-20.

*3 Frame rate in high speed mode when the camera is connected using two camera cables. For other conditions, refer to the table on the next page.







Model			FH-SM02	FH-SC02	FH-SM04	FH-SC04	FH-SM12	FH-SC12	FH-SMX	FH-SCX	FH-SMX05	FH-SCX05	FH-SMX12	FH-SCX12	FH-SM21R	FH-SC21R
Image Acquisition Time *4	2 Cables *5	High Speed Mode *6	4.6 ms		8.5 ms		25.7 ms		---		10.3 ms		24.9 ms		42.6 ms	
		Standard Mode	9.7 ms		17.9 ms		51.3 ms		---		22.1 ms		53.5 ms		90.1 ms	
	1 Cables	High Speed Mode *6	9.2 ms		17.0 ms		51.3 ms		1.9 ms		20.6 ms		50.0 ms		83.3 ms	
		Standard Mode	19.3 ms		35.8 ms		102.0 ms		3.8 ms		44.1 ms		106.4 ms		175.4 ms	

*4 The image acquisition time does not include the image conversion processing time of the sensor controller.

*5 Two Camera ports of the controller are used per one camera.

*6 Up to 5 m Camera Cable length.

Camera Cables

Item	Descriptions	Model *3
	Camera Cable Cable length: 2 m, 3 m, 5m, or 10 m *2	FZ-VS3 □M
	Bend resistant Camera Cable Cable length: 2 m, 3 m, 5m, or 10 m *2	FZ-VSB3 □M
	Right-angle Camera Cable *1 Cable length: 2 m, 3 m, 5m, or 10 m *2	FZ-VSL3 □M
	Bend resistant Right-angle Camera Cable *1 Cable length: 2 m, 3 m, 5 m, or 10 m *2	FZ-VSLB3 □M
	Long-distance Camera Cable Cable length: 15 m *2	FZ-VS4 15M
	Long-distance Right-angle Camera Cable *1 Cable length: 15 m *2	FZ-VSL4 15M
	Cable Extension Unit Up to two Extension Units and three Cables can be connected. (Maximum cable length: 45 m *2)	FZ-VSJ

*1 This Cable has an L-shaped connector on the Camera end.

*2 The maximum cable length depends on the camera being connected, and the model and length of the cable being used. For further information, refer to the Cameras / Cables Connection Table and Maximum Extension Length Using Cable Extension Units FZ-VSJ table.

When a High-speed Digital CMOS Camera FH-S□02/-S□04/-S□12/-S□21R is used in the high speed mode of transmission speed, two camera cables are required.

*3 Insert the cables length into □ in the model number as follows. 2 m = 2, 3 m = 3, 5 m = 5, 10 m = 10

Cameras / Cables Connection Table

Camera Cables	Model	Cable length	High-speed Digital CMOS cameras						
			300,000-pixel	2 million-pixel		4 million-pixel		12 million-pixel	
			FH-SM/SC	FH-SM02/SC02		FH-SM04/SC04		FH-SM12/SC12	
			High speed mode of transmission speed select	Standard mode of transmission speed select	High speed mode of transmission speed select	Standard mode of transmission speed select	High speed mode of transmission speed select	Standard mode of transmission speed select	
Camera Cables Right-angle camera cables	FZ-VS3 FZ-VSL3	2 m	Yes	Yes	Yes	Yes	Yes	Yes	Yes
		3 m	Yes	Yes	Yes	Yes	Yes	Yes	Yes
		5 m	Yes	Yes	Yes	Yes	Yes	Yes	Yes
		10 m	Yes	No	Yes	No	Yes	No	Yes
Bend resistant camera cables Bend resistant Right-angle Camera Cable	FZ-VSB3 FZ-VSLB3	2 m	Yes	Yes	Yes	Yes	Yes	Yes	Yes
		3 m	Yes	Yes	Yes	Yes	Yes	Yes	Yes
		5 m	Yes	Yes	Yes	Yes	Yes	Yes	Yes
		10 m	Yes	No	Yes	No	Yes	No	Yes
Long-distance camera cable Long-distance right-angle camera cable	FZ-VS4 FZ-VSL4	15 m	Yes	No	Yes	No	Yes	No	Yes

Camera Cables	Model	Cable length	High-speed Digital CMOS cameras						
			400,000-pixel		5 million-pixel		12 million-pixel		
			FH-SMX/SCX		FH-SMX05/SCX05		FH-SMX12/SCX12		
			High speed mode of transmission speed select	Standard mode of transmission speed select	High speed mode of transmission speed select	Standard mode of transmission speed select	High speed mode of transmission speed select	Standard mode of transmission speed select	
Camera Cables Right-angle camera cables	FZ-VS3 FZ-VSL3	2 m	Yes	Yes	Yes	Yes	Yes	Yes	Yes
		3 m	Yes	Yes	Yes	Yes	Yes	Yes	Yes
		5 m	Yes	Yes	Yes	Yes	Yes	Yes	Yes
		10 m	No	Yes	No	Yes	No	Yes	
Bend resistant camera cables Bend resistant Right-angle Camera Cable	FZ-VSB3 FZ-VSLB3	2 m	Yes	Yes	Yes	Yes	Yes	Yes	Yes
		3 m	Yes	Yes	Yes	Yes	Yes	Yes	Yes
		5 m	Yes	Yes	Yes	Yes	Yes	Yes	Yes
		10 m	No	Yes	No	Yes	No	Yes	
Long-distance camera cable Long-distance right-angle camera cable	FZ-VS4 FZ-VSL4	15 m	No	Yes	No	Yes	No	Yes	

Camera Cables	Model	Cable length	Digital CMOS Camera			Digital CCD cameras		
			5 million-pixel	20.4 million-pixel		5 million-pixel	300,000-pixel	2 million-pixel
			FH-SM05R/ SC05R	FH-SM21R/SC21R		FZ-S5M3/ SC5M3	FZ-S/SC	FZ-S2M/SC2M
			High speed mode of transmission speed select	Standard mode of transmission speed select				
Camera Cables Right-angle camera cables	FZ-VS3 FZ-VSL3	2 m	Yes	Yes	Yes	Yes	Yes	Yes
		3 m	Yes	Yes	Yes	Yes	Yes	Yes
		5 m	Yes	Yes	Yes	Yes	Yes	Yes
		10 m	Yes	No	Yes	No	Yes	Yes
Bend resistant camera cables Bend resistant Right-angle Camera Cable	FZ-VSB3 FZ-VSLB3	2 m	Yes	Yes	Yes	Yes	Yes	Yes
		3 m	Yes	Yes	Yes	Yes	Yes	Yes
		5 m	Yes	Yes	Yes	Yes	Yes	Yes
		10 m	Yes	No	Yes	No	Yes	Yes
Long-distance camera cable Long-distance right-angle camera cable	FZ-VS4 FZ-VSL4	15 m	Yes	No	Yes	No	Yes	Yes

Camera Cables	Model	Cable length	Small digital CCD cameras Pen type / flat type		Intelligent Compact Digital CMOS Camera	
			FZ-SF/SFC FZ-SP/SPC		FZ-SQ□	
Camera Cables Right-angle camera cables	FZ-VS3 FZ-VSL3	2 m		Yes		Yes
		3 m		Yes		Yes
		5 m		Yes		Yes
		10 m		Yes		Yes
Bend resistant camera cables Bend resistant Right-angle Camera Cable	FZ-VSB3 FZ-VSLB3	2 m		Yes		Yes
		3 m		Yes		Yes
		5 m		Yes		Yes
		10 m		Yes		Yes
Long-distance camera cable Long-distance right-angle camera cable	FZ-VS4 FZ-VSL4	15 m		Yes		Yes

Maximum Extension Length Using Cable Extension Units FZ-VSJ

Item	Model	Transmission speed (*1)	No. of CH used for connection (*2)	Maximum cable length using 1 Camera Cable (*1)	Max. number of connectable Extension Units	Using Cable Extension Units FZ-VSJ		
						Max. cable length	Connection configuration	
High-speed Digital CMOS Cameras	FH-SM/SC	---	---	15 m (Using FZ-VS4/VSL4)	2	45 m	[Configuration 1] Camera cable: 15 m × 3 Extension Unit: 2	
	FH-SMX/SCX	Standard	---	15 m (Using FZ-VS4/VSL4)	2	45 m	[Configuration 1] Camera cable: 15 m × 3 Extension Unit: 2	
		High speed	---	5 m (Using FZ-VS□/VSL□)	2	15 m	[Configuration 3] Camera cable: 5 m × 3 Extension Unit: 2	
	FH-SM02/SC02 FH-SM04/SC04 FH-SM12/SC12 FH-SMX05/SCX05 FH-SMX12/SCX12	Standard	1	15 m (Using FZ-VS4/VSL4)	2	45 m	[Configuration 1] Camera cable: 15 m × 3 Extension Unit: 2	
			2	15 m (Using FZ-VS4/VSL4)	4 (*3)	45 m	[Configuration 2] Camera cable: 15 m × 6 Extension Unit: 4	
		High speed	1	5 m (Using FZ-VS□/VSL□)	2	15 m	[Configuration 3] Camera cable: 5 m × 3 Extension Unit: 2	
			2	5 m (Using FZ-VS□/VSL□)	4 (*3)	15 m	[Configuration 4] Camera cable: 5 m × 6 Extension Unit: 4	
	Digital CMOS Cameras	FH-SM21R/SC21R	Standard	1	15 m (Using FZ-VS4/VSL4)	2	45 m	[Configuration 1] Camera cable: 15 m × 3 Extension Unit: 2
2				15 m (Using FZ-VS4/VSL4)	4 (*3)	45 m	[Configuration 2] Camera cable: 15 m × 6 Extension Unit: 4	
High speed			1	5 m (Using FZ-VS□/VSL□)	2	15 m	[Configuration 3] Camera cable: 5 m × 3 Extension Unit: 2	
			2	5 m (Using FZ-VS□/VSL□)	4 (*3)	15 m	[Configuration 4] Camera cable: 5 m × 6 Extension Unit: 4	
FH-SM05R/SC05R		---	---	15 m (Using FZ-VS□/VSL□)	2	45 m	[Configuration 1] Camera cable: 15 m × 3 Extension Unit: 2	
FZ-S5M3/SC5M3		---	---	5 m (Using FZ-VS□/VSL□)	2	15 m	[Configuration 3] Camera cable: 5 m × 3 Extension Unit: 2	
Digital CCD Cameras		FZ-S/SC FZ-S2M/SC2M	---	---	15 m (Using FZ-VS4/VSL4)	2	45 m	[Configuration 1] Camera cable: 15 m × 3 Extension Unit: 2
Small Digital CCD Cameras Flat type/ Pen type		FZ-SF/SFC FZ-SP/SPC	---	---	15 m (Using FZ-VS4/VSL4)	2	45 m	[Configuration 1] Camera cable: 15 m × 3 Extension Unit: 2
Intelligent Compact Digital CMOS Camera	FZ-SQ□	---	---	15 m (Using FZ-VS4/VSL4)	2	45 m	[Configuration 1] Camera cable: 15 m × 3 Extension Unit: 2	

- *1 The FH-S□□□ enables switching between standard and high speed modes. In high speed mode, images can be transferred approximately two times faster than in standard mode, but the connectable cable length will be shorter.
- *2 The FH-S□□□ has two channels to connect Camera Cables. Connection to two channels makes image transfer two times faster than connection to one channel: high speed mode using two channels can transfer approximately four times as many images as standard mode using one channel.
- *3 Each channel can be used to connect up to two Cable Extension Units: up to four extension units, two channels x two units, can be connected by using two channels.

Connection Configuration

	Connection configuration using the maximum length of Camera Cables	Remarks
Configuration 1		
Configuration 2		
Configuration 3		
Configuration 4		

*4 Select the Camera Cables between the Controller and Extension Unit, between the Extension Units, and between the Extension Unit and Camera according to the connected Camera.
Different types or lengths of Camera Cables can be used for (1), (2), and (3) as well as for (4), (5), and (6). However, the type and length of Camera Cable (1) must be the same as those of Camera Cable (4), (2) must be the same as (5), and (3) must be the same as (6).

Monitor

Item	Descriptions	Model
	Touch Panel Monitor 12.1 inches For FH Sensor Controllers *	FH-MT12
	LCD Monitor 8.4 inches	FZ-M08

* FH Series Sensor Controllers version 5.32 or higher is required.

Monitor Cables

Item	Descriptions	Model
	DVI-Analog Conversion Cable for Touch Panel Monitor/LCD Monitor Cable length: 2 m, 5 m or 10 m	FH-VMDA □□ *1
	RS-232C Cable for Touch Panel Monitor Cable length: 2 m, 5 m or 10 m	XW2Z-□□□PP-1 *2
	USB Cable for Touch Panel Monitor Cable length: 2 m or 5 m	FH-VUAB □□ *1

*1 Insert the cables length into □ in the model number as follows. 2 m = 2, 5 m = 5, 10 m = 10

*2 Insert the cables length into □□□ in the model number as follows. 2 m = 200, 5 m = 500, 10 m = 010.

A video signal cable and an operation signal cable are required to connect the Touch Panel Monitor.

Signal	Cable	2 m	5 m	10 m
Video signal	DVI-Analog Conversion Cable	Yes	Yes	Yes
Touch panel operation signal	USB Cable	Yes	Yes	No
	RS-232C Cable	Yes	Yes	Yes

Parallel I/O Cables/Encoder Cable

Item	Descriptions	Model
	Parallel I/O Cable *1 Cable length: 2m, 5m or 15m	XW2Z-S013-□ *2
	Parallel I/O Cable for Connector-terminal Conversion Unit *1 Cable length: 0.5 m, 1 m, 1.5 m, 2 m, 3 m, 5 m Connector-Terminal Block Conversion Units can be connected (Terminal Blocks Recommended Products: OMRON XW2R-□34G-T)	XW2Z-□□□EE *3
	Connector-Terminal Block Conversion Units, General-purpose devices	XW2R-□34GD-T *4
	Encoder Cable for line-driver Cable length: 1.5 m	FH-VR 1.5M

*1 2 Cables are required for all I/O signals.





*2 Insert the cables length into □ in the model number as follows. 2 m = 2, 5 m = 5, 15 m = 15

*3 Insert the cables length into □□□ in the model number as follows. 0.5 m = 050, 1 m = 100, 1.5 m = 150, 2 m = 200, 3 m = 300, 5 m = 500

*4 Insert the wiring method into □ in the model number as follows. Phillips screw = J, Slotted screw (rise up) = E, Push-in spring = P
Refer to the XW2R Series catalog (Cat. No. G077) for details.

Parallel Converter Cable

When you change to connect the F series, FZ5 series, or FZ5-L series to FH series Sensor Controller, you can convert by using the appropriate parallel converter cable of FH-VPX series under the usable condition.

Item	Applicable Model	Usable Condition	Model	
	FZ□ series	<ul style="list-style-type: none"> Do not use RESET signal. * Use with COMIN and COMUT are same power source. 	FH-VPX-FZ	
	FZ□-L35x series	<ul style="list-style-type: none"> Do not use RESET signal. * 	FH-VPX-FZL	
	F160 series	F160-C10	<ul style="list-style-type: none"> Do not use RESET signal. * Use with COMIN and COMOUT are same power source. Do not use DI5 and DI6. 	FH-VPX-F160
	F210 series	F210-C10	<ul style="list-style-type: none"> Do not use RESET signal. * Use with COMIN and COMOUT are same power source. Do not use DI8 and DI9. 	FH-VPX-F210
		F210-C10-ETN		
	F500 series	F500-C10		

* Even if RESET signal cannot be use by conversion, conversion is possible to convert satisfying other usable condition.





Note: Cannot be used for the F160-C10CP/-C10CF.

Recommended EtherCAT and EtherNet/IP Communications Cables

Use Straight STP (shielded twisted-pair) cable of category 5 or higher with double shielding (braiding and aluminum foil tape) for EtherCAT.

Use Straight or cross STP (shielded twisted-pair) cable of category 5 or higher for EtherNet/IP.

Cable with Connectors

Item	Appearance	Recommended manufacturer	Cable length (m)	Model
Cable with Connectors on Both Ends (RJ45/RJ45) Standard RJ45 plugs type *1 Wire Gauge and Number of Pairs: AWG26, 4-pair Cable Cable Sheath material: LSZH *2 Cable color: Yellow *3		OMRON	0.3	XS6W-6LSZH8SS30CM-Y
			0.5	XS6W-6LSZH8SS50CM-Y
			1	XS6W-6LSZH8SS100CM-Y
			2	XS6W-6LSZH8SS200CM-Y
			3	XS6W-6LSZH8SS300CM-Y
			5	XS6W-6LSZH8SS500CM-Y
Cable with Connectors on Both Ends (RJ45/RJ45) Rugged RJ45 plugs type *1 Wire Gauge and Number of Pairs: AWG22, 2-pair Cable Cable color: Light blue		OMRON	0.3	XS5W-T421-AMD-K
			0.5	XS5W-T421-BMD-K
			1	XS5W-T421-CMD-K
			2	XS5W-T421-DMD-K
			5	XS5W-T421-GMD-K
			10	XS5W-T421-JMD-K
Cable with Connectors on Both Ends (M12 Straight/M12 Straight) Shield Strengthening Connector cable *4 M12/Smartclick Connectors Wire Gauge and Number of Pairs: AWG22, 2-pair Cable Cable color: Black		OMRON	0.5	XS5W-T421-BM2-SS
			1	XS5W-T421-CM2-SS
			2	XS5W-T421-DM2-SS
			3	XS5W-T421-EM2-SS
			5	XS5W-T421-GM2-SS
			10	XS5W-T421-JM2-SS
Cable with Connectors on Both Ends (M12 Straight/RJ45) Shield Strengthening Connector cable *4 M12/Smartclick Connectors Rugged RJ45 plugs type Wire Gauge and Number of Pairs: AWG22, 2-pair Cable Cable color: Black		OMRON	0.5	XS5W-T421-BMC-SS
			1	XS5W-T421-CMC-SS
			2	XS5W-T421-DMC-SS
			3	XS5W-T421-EMC-SS
			5	XS5W-T421-GMC-SS
			10	XS5W-T421-JMC-SS

*1 Cables with standard RJ45 plugs are available in the following lengths: 0.2 m, 0.3 m, 0.5 m, 1 m, 1.5 m, 2 m, 3 m, 5 m, 7.5 m, 10 m, 15 m, 20 m. Cables with rugged RJ45 plugs are available in the following lengths: 0.3 m, 0.5 m, 1 m, 2 m, 3 m, 5 m, 10 m, 15 m. For details, refer to the Industrial Ethernet Connectors Catalog (Cat. No. G019).

*2 The lineup features Low Smoke Zero Halogen cables for in-cabinet use and PUR cables for out-of-cabinet use. Although the LSZH cable is single shielded, its communications and noise characteristics meet the standards.

*3 Cables colors are available in yellow, green, and blue.

*4 For details, contact your OMRON representative.

Cables / Connectors

Item	Recommended manufacturer	Model
Products for EtherCAT or EtherNet/IP (1000BASE-T/100BASE-TX) Wire gauge and number of pairs: AWG24, 4-pair cable	Cable	Hitachi Metals, Ltd. NETSTAR-C5E SAB 0.5 x 4P CP *1
		Kuramo Electric Co. KETH-SB *1
		SWCC Showa Cable Systems Co. FAE-5004 *1
Products for EtherCAT or EtherNet/IP (100BASE-TX/10BASE-T) Wire gauge and number of pairs: AWG22, 2-pair cable	RJ45 Connector	Panduit Corporation MPS588-C *1
	Cable	Kuramo Electric Co. KETH-PSB-OMR *2
		JMACS Japan Co., Ltd. PNET/B *2
	RJ45 Assembly Connector	OMRON XS6G-T421-1 *2

*1 We recommend you to use the above Cable and RJ45 Connector together.

*2 We recommend you to use the above Cable and RJ45 Assembly Connector together.

Automation Software Sysmac Studio

Please purchase a DVD and licenses the first time you purchase the Sysmac Studio. DVDs and licenses are available individually. The license does not include the DVD.

Item	Specifications			Model
		Number of licenses	Media	
Sysmac Studio Standard Edition Ver.1.□□□	The Sysmac Studio is the software that provides an integrated environment for setting, programming, debugging and maintenance of machine automation controllers including the NJ/NX-series CPU Units, NY-series Industrial PC, EtherCat Slave, and the HMI. Sysmac Studio runs on the following OS. Windows 7 (32-bit/64-bit version) / Windows 8 (32-bit/64-bit version) / Windows 8.1 (32-bit/64-bit version) / Windows 10 Pro (32/64bit) or Enterprise (32/64bit) *1 This software provides functions of the Vision Edition. Refer to OMRON website for details such as supported models and functions.	-- (Media only)	Sysmac Studio (32bit) DVD *2	SYSMAC-SE200D
		-- (Media only)	Sysmac Studio (64bit) DVD *2	SYSMAC-SE200D-64
		1 license	—	SYSMAC-SE201L
		3 license	—	SYSMAC-SE203L
		10 license	—	SYSMAC-SE210L
		30 license	—	SYSMAC-SE230L
		50 license	—	SYSMAC-SE250L
Sysmac Studio Vision Edition Ver.1.□□□ *3 *4	Sysmac Studio Vision Edition is a limited license that provides selected functions required for Vision Sensor FH-series/ Smart Camera FHV7-series/FQ-M-series settings.	1 license	—	SYSMAC-VE001L
Sysmac Studio Robot Additional Option *4	Sysmac Studio Robot Additional Option is a license to enable the Vision & Robot integrated simulation.	1 license	—	SYSMAC-RA401L

Note: 1. Site licenses are available for users who will run Sysmac Studio on multiple computers. Ask your OMRON sales representative for details.
2. Sysmac Studio version 1.07 or higher supports the FH Series. Sysmac Studio does not support the FH-L550/L550-10.

*1 Model "SYSMAC-SE200D-64" runs on Windows 10 (64bit).

*2 The same media is used for both the Standard Edition and the Vision Edition.

*3 With the Vision Edition, you can use only the setup functions for FH-series/FQ-M-series Vision Sensors.











*4 This product is a license only. You need the Sysmac Studio Standard Edition DVD media to install it.

Development Environment

Please purchase a CD-ROM and licenses the first time you purchase the Application Producer. CD-ROMs and licenses are available individually. The license does not include the CD-ROM.

Product	Specifications			Model
		Number of Model Standards licenses	Media	
Application Producer	Software components that provide a development environment to further customize the standard controller features of the FH Series. System requirements: CPU: Intel Pentium Processor (SSE2 or higher) OS: Windows 7 Professional (32/64bit) or Enterprise(32/64bit) or Ultimate (32/64bit), Windows 8 Pro (32/64bit) or Enterprise (32/64bit), Windows 8.1 Pro (32/64bit) or Enterprise (32/64bit), Windows 10 Pro (32/64bit) or Enterprise (32/64bit) .NET Framework: .NET Framework 3.5 SP1 or higher Memory: At least 2 GB RAM Available disk space: At least 2 GB Browser: Microsoft® Internet Explorer 6.0 or later Display: XGA (1024 × 768), True Color (32-bit) or higher Optical drive: CD/DVD drive The following software is required to customize the software: Microsoft® Visual Studio® 2008 Professional or Microsoft® Visual Studio® 2010 Professional or Microsoft® Visual Studio® 2012 Professional	-- (Media only)	CD-ROM	FH-AP1
		1 license	—	FH-AP1L

Accessories

Item	Descriptions			Model		
	USB Memory	2 GB		FZ-MEM2G		
		8 GB		FZ-MEM8G		
	SD Card	2 GB		HMC-SD291		
		4 GB		HMC-SD491		
	Display/USB Switcher			FZ-DU		
—	Mouse Recommended Products Driverless wired mouse (A mouse that requires the mouse driver to be installed is not supported.)			---		
	EtherCAT junction slaves	3 port	Power supply voltage: 20.4 to 28.8 VDC (24 VDC -15 to 20%)	Current consumption: 0.08 A	GX-JC03	
		6 port		Current consumption: 0.17 A	GX-JC06	
	Industrial Switching Hubs for EtherNet/IP and Ethernet	5 port		Current consumption: 0.07 A	W4S1-05D	
—	Calibration Plate			FZD-CAL		
	Common items related to DIN rail (for FH-L550/-L550-10)	DIN rail mounting bracket (For Lite Controllers)		<ul style="list-style-type: none"> • Length: 75.5/95.5/115.5/200 cm • Height: 7.5mm • Material: Iron • Surface: Conductive 	FH-XDM-L	
		DIN 35mm rail	PHOENIX CONTACT		<ul style="list-style-type: none"> • Length: 75.5/95.5/115.5/200 cm • Height: 15mm • Material: Iron • Surface: Conductive 	NS 35/7,5 PERF
		End plate	PHOENIX CONTACT		Need 2 pieces each Sensor Controller	CLIPFIX 35
—		External Lights	External lighting controller		LED	FLV Series
—	External Lights	External lighting controller	High-brightness LED	FL-BR/DR Series		
—	External Lights	External lighting controller	Photometric Stereo Light	FL-PS Series		
—	External Lights	Built-in lighting controller	MDMC Light	FL-MD Series		
	For Intelligent Compact Digital CMOS Camera	Mounting Bracket		FQ-XL		
		Mounting Brackets		FQ-XL2		
		Polarizing Filter Attachment		FQ-XF1		
—	Mounting Bracket for FZ-S□, FH-S□05R, FZ-S□X			FZ-S-XLC		
	Mounting Bracket for FZ-S□2M			FZ-S2M-XLC		
	Mounting Bracket for FH-S□, FZ-S□5M□, FH-S□X05, FH-S□X12, FH-S□21R			FH-SM-XLC		
	Mounting Bracket for FH-S□12			FH-SM12-XLC		
—	M42 - F Mount Conversion Adapter			FH-ADF/M42-10		

* Refer to the Vision Accessory Catalog (Cat. No. Q198) for details.

FH-Series

Lenses

Refer to the *Vision Accessory Catalog* (Cat. No. Q198) for details.

Resolution	Camera Model	Size of image element	Recommended lens				
			Standard Lens	Telecentric Lens	Vibrations and Shocks Resistant Lens		
300,000-pixel	FZ-SF/SFC	1/3" equivalent	FZ-LES Series	---	---		
	FZ-SP/SPC						
	FZ-S/SC		SV-V Series	VS-TCH Series	VS-MCA Series Non-telecentric Macro VS-MC Series		
	FH-SM/SC						
400,000-pixel	FH-SMX/SCX	1/2.9" equivalent	SV-H Series			VS-H1 Series	VS-MCA Series VS-MCH1 Series
2 million-pixel	FZ-S2M/SC2M	1/1.8" equivalent	SV-H Series			VS-TEV Series	VS-MCA Series VS-MCH1 Series
4 million-pixel	FH-SM02/SC02	2/3" equivalent	VS-H1 Series	VS-TEV Series	VS-MCA Series VS-MCH1 Series		
5 million-pixel	FH-SM04/SC04	1" equivalent	SV-H Series	VS-TCH Series	VS-MCA Series Non-telecentric Macro VS-MC Series		
	FH-SM05R/SC05R	1/2.5" equivalent					
	FZ-S5M3/SC5M3	2/3" equivalent					
12 million-pixel	FH-SMX05/SCX05	2/3" equivalent	VS-LLD Series	VS-TEV Series	---		
	FH-SMX12/SCX12	1.1" equivalent	VS-L/M42-10 Series	---	VS-MCL/M42-10 Series		
20.4 million-pixel	FH-SM12/SC12	1.76" equivalent	VS-LLD Series	VS-TEV Series	VS-MCH1 Series		
20.4 million-pixel	FH-SM21R/SC21R	1" equivalent	VS-LLD Series	VS-TEV Series	VS-MCH1 Series		

Ratings and Specifications (FH Sensor Controllers)

High-speed, Large-capacity Controller

Sensor Controller Series		FH-5550/5050 Series			FH-2050 Series			
Sensor Controller Model		FH-5550/5050	FH-5550/5050-10	FH-5550/5050-20	FH-2050	FH-2050-10	FH-2050-20	
Parallel IO		NPN/PNP (common)						
Memory, Storage		FH-5550 series : 32GB RAM, 64GB ROM FH-5050 series : 8GB RAM, 32GB ROM			8GB RAM, 32GB ROM			
Number of cores		4 cores			2 cores			
Main Functions	Operation Mode	Standard	Yes					
		Double Speed Multi-input	Yes					
		Non-stop adjustment mode	Yes					
		Multi-line random-trigger mode	Yes (Maximum 8 lines) *1					
	Parallel Processing		Yes					
	Number of Connectable Camera		2	4	8	2	4	8
	Supported Camera	FH-S series camera	All of the FH-S series cameras are connectable.		All of the FH-S series cameras are connectable. *2	All of the FH-S series cameras are connectable.		All of the FH-S series cameras are connectable. *2
		FZ-S series camera	All of the FZ-S series cameras are connectable.					
	Camera I/F		OMRON I/F					
	Possible Number of Captured Images		Refer to page 31.					
	Possible Number of Logging Images to Sensor Controller		Refer to the <i>Vision System FH/FZ5 Series User's Manual</i> (Cat. No. Z365).					
	Possible Number of Scenes		128					
	Operating on UI	USB Mouse	Yes (wired USB and driver is unnecessary type)					
		Touch Panel	Yes (RS-232C/USB connection: FH-MT12)					
Setup		Create the processing flow using Flow editing.						
Language		Japanese, English, Simplified Chinese, Traditional Chinese, Korean, German, French, Spanish, Italian, Vietnamese, Polish						
Serial Communication		RS-232C × 1						
Ethernet Communication	Protocol	Non-procedure (TCP/UDP)						
	I/F	1000BASE-T × 2						
EtherNet/IP Communication		Yes (Target/Ethernet port)						
PROFINET Communication		<ul style="list-style-type: none"> • Yes (Slave/Ethernet port) • Conformance class A 						
EtherCAT Communication		Yes (slave) Refer to page 36 about EtherCAT Communications Specifications.						
External Interface	Parallel I/O	<ul style="list-style-type: none"> • 12 inputs/31 outputs: <ul style="list-style-type: none"> • Use 1 Line. • Operation mode: Except Multi-line random-trigger mode. • 17 inputs/37 outputs: <ul style="list-style-type: none"> • Use 2 Lines. • Operation mode: Multi-line random-trigger mode. • 14 inputs/29 outputs: <ul style="list-style-type: none"> • Use 3 to 4 Lines. • Operation mode: Multi-line random-trigger mode. • 19 inputs/34 outputs: <ul style="list-style-type: none"> • Use 5 to 8 Lines. • Operation mode: Multi-line random-trigger mode. 						
		Encoder Interface		Input voltage: 5 V ± 5% Signal: RS-422A Line Driver Level Phase A/B/Z: 1 MHz				
		Monitor Interface		DVI-I output (Analog RGB & DVI-D single link) × 1				
		USB I/F		USB3.0 host × 2 (BUS Power: Port5 V/0.5 A) USB2.0 host × 4 (BUS Power: Port5 V/0.5 A)				
	SD Card I/F		SDHC × 1					
Indicator Lamps	Main	POWER: Green ERROR: Red RUN: Green ACCESS: Yellow						
	Ethernet	NET RUN1: Green LINK/ACT1: Yellow NET RUN2: Green LINK/ACT2: Yellow						
	SD Card	SD POWER: Green SD BUSY: Yellow						
	EtherCAT	ECAT RUN: Green LINK/ACT IN: Green LINK/ACT OUT: Green ECAT ERR: Red						
Power-supply voltage		20.4 VDC to 26.4 VDC						
Current consumption	When connecting an intelligent compact digital camera • When connecting the following light or lighting controller without an external power supply FLV-TCC1, FLV-TCC4, FLV-TCC3HB FLV-TCC1EP, FL-TCC1 • When connecting the following light or lighting controller FL-TCC1PS, FL-MD□MC	5.6 A max.	7.7 A max.	12.2 A max.	4.6 A max.	6.6 A max.	11.2 A max.	
	Other than above	4.5 A max.	5.5 A max.	7.3 A max.	3.5 A max.	4.3 A max.	6.3 A max.	
Built-in FAN		Yes						
Usage Environment	Ambient temperature range		Operating: 0°C to +45°C Storage: -20 to +65°C (with no icing or condensation)			Operating: 0°C to +50°C Storage: -20 to +65°C (with no icing or condensation)		
	Ambient humidity range		Operating: 35 to 85%RH Storage: 35 to 85%RH (with no condensation)					
	Ambient atmosphere		No corrosive gases					
	Vibration tolerance		Oscillation frequency: 10 to 150 Hz Half amplitude: 0.1 mm Acceleration: 15 m/s ² Sweep time: 8 minute/count Sweep count: 10 Vibration direction: up and down/front and behind/left and right					
	Shock resistance		Impact force: 150 m/s ² Test direction: up and down/front and behind/left and right					
	Noise immunity	Fast Transient Burst	<ul style="list-style-type: none"> • DC power Direct infusion: 2kV, Pulse rising: 5ns, Pulse width: 50ns, Burst continuation time: 15ms/0.75ms, Period: 300ms, Application time: 1 min • I/O line Direct infusion: 1kV, Pulse rising: 5ns, Pulse width: 50ns, Burst continuation time: 15ms/0.75ms, Period: 300ms, Application time: 1 min 					
Grounding			Type D grounding (100 Ω or less grounding resistance) *3					
External Features	Dimensions		190 mm × 115 mm × 182.5 mm Note Height: Including the feet at the base.					
	Weight		Approx. 3.4 kg	Approx. 3.6 kg	Approx. 3.6 kg	Approx. 3.4 kg	Approx. 3.6 kg	
	Degree of protection		IEC60529 IP20					
Case material		Cover: zinc-plated steel plate Side plate: aluminum (A6063)						
Accessories		Instruction Sheet (Japanese and English): 1, Installation Instruction Manual for FH series:1, General Compliance Information and Instructions for EU:1, Member registration sheet: 1, Power source (FH-XCN): 1 (male), Ferrite core for camera cable: 2 (FH-S□50, FH-2050), 4 (FH-S□50-10, FH-2050-10), 8 (FH-S□50-20, FH-2050-20)						

*1 According to the CPU performance, FH-2050 series is recommended to use up to two lines in this mode.

*2 Up to eight cameras can be connected in total including up to four 12 or 20.4 million-pixel cameras.

*3 Existing third class grounding

Lite Controllers

Sensor Controller Series		FH-L550 Series		
Sensor Controller Model		FH-L550	FH-L550-10	
Parallel IO		NPN/PNP (common)		
Memory, Storage		4GB RAM, 4GB ROM		
Main Functions	Operation Mode	Standard	Yes	
		Double Speed Multi-input	Yes	
		Non-stop adjustment mode	Yes	
		Multi-line random-trigger mode	No	
	Parallel Processing		Yes	
	Number of Connectable Camera		2	4
	Supported Camera	FH-S series camera	All of the FH-S series cameras except FH-SM21R/SC21R	
		FZ-S series camera	All of the FZ-S series cameras are connectable.	
	Camera I/F		OMRON I/F	
	Possible Number of Captured Images		Refer to page 31.	
	Possible Number of Logging Images to Sensor Controller		Refer to the <i>Vision System FH/FZ5 Series User's Manual</i> (Cat. No. Z365).	
	Possible Number of Scenes		128	
	UI Operations	USB Mouse	Yes (wired USB driver-less type)	
		Touch Panel	Yes (RS-232C/USB connection: FH-MT12)	
Setup		Create the processing flow using Flow editing.		
Language		Japanese, English, Simplified Chinese, Traditional Chinese, Korean, German, French, Spanish, Italian, Vietnamese, Polish		
External Interface	Serial Communication		RS-232C × 1	
	Ethernet Communication	Protocol	Non-procedure (TCP/UDP)	
		I/F	1000BASE-T × 1	
	EtherNet/IP Communication		Yes (Target/Ethernet port)	
	PROFINET Communication		<ul style="list-style-type: none"> • Yes (Slave/Ethernet port) • Conformance class A 	
	EtherCAT Communication		No	
	Parallel I/O		<ul style="list-style-type: none"> • High-speed input: 1 • Normal speed: 9 • High-speed output: 4 • Normal speed: 23 	
	Encoder Interface		None	
	Monitor Interface		DVI-I output (Analog RGB & DVI-D single link) × 1	
	USB I/F		USB2.0 host × 1: BUS Power: Port 5 V/0.5 A USB3.0 × 1: BUS Power: Port 5 V/0.5 A	
SD Card I/F		SDHC × 1		
Indicator Lamps	Main	POWER: Green ERROR: Red RUN: Green ACCESS: Yellow		
	Ethernet	NET RUN: Green LINK/ACT: Yellow		
	SD Card	SD POWER: Green SD BUSY: Yellow		
	EtherCAT	None		
Power-supply voltage		20.4 VDC to 26.4 VDC		
Current consumption	When connecting an intelligent compact digital camera • When connecting the following light or lighting controller without an external power supply FLV-TCC1, FLV-TCC4, FLV-TCC3HB FLV-TCC1EP, FL-TCC1 • When connecting the following light or lighting controller FL-TCC1PS, FL-MD□MC	2.7 A max.	4.4 A max.	
	Other than above	1.5 A max.	2.0 A max.	
	Built-in FAN	No		
Usage Environment	Ambient temperature range		Operating: 0°C to 55°C Storage: -25 to +70°C	
	Ambient humidity range		Operating and Storage: 10 to 90%RH (with no condensation)	
	Ambient atmosphere		No corrosive gases	
	Vibration tolerance		5 to 8.4 Hz with 3.5 mm amplitude, 8.4 to 150 Hz, acceleration of 9.8 m/s ² 100 min each in X, Y, and Z directions (10 sweeps of 10 min each = 100 min total)	
	Shock resistance		Impact force: 150 m/s ² Test direction: up and down/front and behind/left and right	
	Noise immunity	Fast Transient Burst	<ul style="list-style-type: none"> • DC power Direct infusion: 2kV, Pulse rising: 5ns, Pulse width: 50ns, Burst continuation time: 15ms/0.75ms, Period: 300ms, Application time: 1 min • I/O line Direct infusion: 1kV, Pulse rising: 5ns, Pulse width: 50ns, Burst continuation time: 15ms/0.75ms, Period: 300ms, Application time: 1 min 	
Grounding			Type D grounding (100 Ω or less grounding resistance) *	
External Features	Dimensions		200 mm × 80 mm × 130 mm	
	Weight		Approx. 1.5 kg	
	Degree of protection		IEC60529 IP20	
	Case materials		PC	
Accessories		Instruction Sheet (Japanese and English): 1, Installation Instruction Manual for FH-L series:1, General Compliance Information and Instructions for EU:1, Member registration sheet: 1, Power source (FH-XCN-L):1 (male)		

* Existing third class grounding

Maximum Number of Loading Images during Multi-input

Camera	Model	Max. Number of Loading Images during Multi-input *1
Intelligent Compact Digital CMOS Cameras *2	FZ-SQ010F/-SQ050F/-SQ100F/-SQ100N	256
0.3 million pixels CCD/CMOS Cameras	FZ-S/-SC/-SF/SFC/-SH/-SHC/-SP/-SPC FH-SM/-SC	256
0.4 million pixels CMOS Cameras	FH-SMX/-SCX	256
2 million pixels CCD Cameras	FZ-S2M/-SC2M	64
2 million pixels CMOS Cameras	FH-SM02/-SC02	51
4 million pixels CMOS Cameras	FH-SM04/-SC04	32
5 million pixels CCD/CMOS Cameras	FZ-S5M3/-SC5M3/-S5M2 FH-SMX05/-SCX05/-SM05R/-SC05R	25
12 million pixels CMOS Cameras	FH-SM12/-SC12/-SMX12/-SCX12	10
20.4 million pixels CMOS Cameras	FH-SM21R/-SC21R	6

*1 When using two camera cables for connection, the maximum number of loaded images during multi-input is twice the number given in the table.

*2 The multi-input function cannot be used when the built-in light of an intelligent compact digital camera is used.
Refer to the *Vision System FH/FZ5 Series User's Manual* (Cat. No. Z340) for details.

FH-Series

Ratings and Specifications (Cameras)

High-speed Digital CMOS cameras

Model	FH-SM		FH-SC		FH-SM02		FH-SC02		FH-SM04		FH-SC04		FH-SM12		FH-SC12	
Image elements	CMOS image elements (1/3-inch equivalent)				CMOS image elements (2/3-inch equivalent)				CMOS image elements (1-inch equivalent)				CMOS image elements (1.76-inch equivalent)			
Color/Monochrome	Monochrome		Color		Monochrome		Color		Monochrome		Color		Monochrome		Color	
Effective pixels	640 (H) × 480 (V)				2040 (H) × 1088 (V)				2040 (H) × 2048 (V)				4084 (H) × 3072 (V)			
Imaging area H x V (opposing corner)	4.8 × 3.6 (6.0 mm)				11.26 × 5.98 (12.76 mm)				11.26 × 11.26 (15.93 mm)				22.5 × 16.9 (28.14 mm)			
Pixel size	7.4 (μm) × 7.4 (μm)				5.5 (μm) × 5.5 (μm)				5.5 (μm) × 5.5 (μm)				5.5 (μm) × 5.5 (μm)			
Shutter function	Electronic shutter; Shutter speeds can be set from 20 μs to 100 ms.				Electronic shutter; Shutter speeds can be set from 25 μs to 100 ms.								Electronic shutter; Shutter speeds can be set from 60 μs to 100 ms.			
Partial function	1 to 480 lines		2 to 480 lines		1 to 1088 lines		2 to 1088 lines		1 to 2048 lines		2 to 2048 lines		4 to 3072 lines (4-line increments)			
Frame rate (Image Acquisition Time *1)	308 fps (3.3 ms)				219 fps (4.6 ms) *2				118 fps (8.5 ms) *2				38.9 fps (25.7 ms) *2			
Lens mounting	C mount												M42 mount			
Field of vision, installation distance	Selecting a lens according to the field of vision and installation distance															
Ambient temperature range	Operating: 0 to 40 °C, Storage: -25 to 65 °C (with no icing or condensation)															
Ambient humidity range	Operating and storage: 35% to 85% (with no condensation)															
Weight	Approx.105 g				Approx.110 g								Approx.320 g			
Accessories	Instruction manual															

Model	FH-SMX		FH-SCX		FH-SMX05		FH-SCX05		FH-SMX12		FH-SCX12					
Image elements	CMOS image elements (1/2.9-inch equivalent)				CMOS image elements (2/3-inch equivalent)				CMOS image elements (1.1-inch equivalent)							
Color/Monochrome	Monochrome		Color		Monochrome		Color		Monochrome		Color					
Effective pixels	720 (H) × 540 (V)				2448 (H) × 2048 (V)				4092 (H) × 3000 (V)							
Imaging area H x V (opposing corner)	4.97 × 3.73 (6.21 mm)				8.45 × 7.07 (11.01 mm)				14.12 × 10.35 (17.5 mm)							
Pixel size	6.9 (μm) × 6.9 (μm)				3.45 (μm) × 3.45 (μm)											
Shutter function	Electronic shutter; Shutter speeds can be set from 1 μs to 100 ms.								Electronic shutter; Shutter speeds can be set from 15 μs to 100 ms.							
Partial function	4 to 540 lines (4-line increments)				4 to 2048 lines (4-line increments)				4 to 3000 lines (4-line increments)							
Frame rate (Image Acquisition Time *1)	523.6 fps (1.9 ms)				97.2 fps (10.3 ms) *2				40.1 fps (24.9 ms) *2							
Lens mounting	C mount															
Field of vision, installation distance	Selecting a lens according to the field of vision and installation distance															
Ambient temperature range	Operating: 0 to 50 °C, Storage: -25 to 65 °C (with no icing or condensation)				Operating: 0 to 40 °C, Storage: -25 to 65 °C (with no icing or condensation)											
Ambient humidity range	Operating and storage: 35% to 85% (with no condensation)															
Weight	Approx.48 g				Approx.85 g											
Accessories	Instruction manual, General Compliance Information and Instructions for EU															

*1 The image acquisition time does not include the image conversion processing time of the sensor controller.

*2 Frame rate in high speed mode when the camera is connected using two camera cables.

Digital CMOS Cameras

Model	FH-SM05R		FH-SC05R		FH-SM21R		FH-SC21R		FZ-S5M3		FZ-SC5M3					
Image Elements	CMOS image elements (1/2.5-inch equivalent)				CMOS image elements (1-inch equivalent)				CMOS image elements (2/3-inch equivalent)							
Color/Monochrome	Monochrome		Color		Monochrome		Color		Monochrome		Color					
Effective Pixels	2592 (H) × 1944 (V)				5544 (H) × 3692 (V)				2448 (H) × 2048 (V)							
Imaging area H x V (opposing corner)	5.70 × 4.28 (7.13 mm)				13.31 × 8.86 (16.00 mm)				8.45 × 7.07 (11.01 mm)							
Pixel Size	2.2 (μm) × 2.2 (μm)				2.4 (μm) × 2.4 (μm)				3.45 (μm) × 3.45 (μm)							
Scan Type	Progressive															
Shutter Method	Rolling shutter (Global reset mode supported)								Global shutter							
Shutter Function	Electronic shutter; Shutter speeds can be set from 500 to 10000 ms in multiples of 50 μs				Electronic shutter; Shutter speeds can be set from 50 μs to 100 ms.				Electronic shutter; Shutter speeds can be set from 20 μs to 100 ms.							
Partial function	4 to 1944 lines (2-line increments)				1848 to 3692 lines				4 to 2048 lines							
Frame rate (Image Acquisition Time *)	14 fps (71.7ms)				23.5 fps (42.6ms)				25.6 fps (38.2ms)							
Lens Mounting	C mount															
Field of vision, Installation distance	Selecting a lens according to the field of vision and installation distance															
Ambient temperature range	Operating: 0 to +40°C Storage: -30 to 65°C (with no icing or condensation)				Operating: 0 to +40°C Storage: -20 to 65°C (with no icing or condensation)				Operating: 0 to +40°C Storage: -30 to 65°C (with no icing or condensation)							
Ambient humidity range	Operating: 35 to 85%RH, Storage: 35 to 85%RH (with no condensation)															
Weight	Approx. 52 g				Approx. 85 g											
Accessories	Instruction Sheet				Instruction Sheet, General Compliance Information and Instructions for EU											

* The image acquisition time does not include the image conversion processing time of the sensor controller.

Digital CCD Cameras

Model	FZ-S	FZ-SC	FZ-S2M	FZ-SC2M
Image elements	Interline transfer reading all pixels, CCD image elements (1/3-inch equivalent)		Interline transfer reading all pixels, CCD image elements (1/1.8-inch equivalent)	
Color/Monochrome	Monochrome	Color	Monochrome	Color
Effective pixels	640 (H) × 480 (V)		1600 (H) × 1200 (V)	
Imaging area H x V (opposing corner)	4.8 × 3.6 (6.0mm)		7.1 × 5.4 (8.9mm)	
Pixel size	7.4 (μm) × 7.4 (μm)		4.4 (μm) × 4.4 (μm)	
Shutter function	Electronic shutter; select shutter speeds from 20 μs to 100 ms			
Partial function	12 to 480 lines		12 to 1200 lines	
Frame rate (Image Acquisition Time *)	80 fps (12.5 ms)		30 fps (33.3 ms)	
Lens mounting	C mount			
Field of vision, installation distance	Selecting a lens according to the field of vision and installation distance			
Ambient temperature range	Operating: 0 to 50 °C Storage: -25 to 65 °C (with no icing or condensation)		Operating: 0 to 40 °C Storage: -25 to 65 °C (with no icing or condensation)	
Ambient humidity range	Operating and storage: 35% to 85% (with no condensation)			
Weight	Approx. 55 g		Approx. 76 g	
Accessories	Instruction manual			

* The image acquisition time does not include the image conversion processing time of the sensor controller.

Small CCD Digital Cameras

Model	FZ-SF	FZ-SFC	FZ-SP	FZ-SPC
Image elements	Interline transfer reading all pixels, CCD image elements (1/3-inch equivalent)			
Color/Monochrome	Monochrome	Color	Monochrome	Color
Effective pixels	640 (H) × 480 (V)			
Imaging area H x V (opposing corner)	4.8 × 3.6 (6.0mm)			
Pixel size	7.4 (μm) × 7.4 (μm)			
Shutter function	Electronic shutter; select shutter speeds from 20 μm to 100 ms			
Partial function	12 to 480 lines			
Frame rate (Image Acquisition Time *)	80 fps (12.5ms)			
Lens mounting	Special mount (M10.5 P0.5)			
Field of vision, installation distance	Selecting a lens according to the field of vision and installation distance			
Ambient temperature range	Operating: 0 to 50 °C (camera amp) 0 to 45 °C (camera head) Storage: -25 to 65 °C (with no icing or condensation)			
Ambient humidity range	Operating and storage: 35% to 85% (with no condensation)			
Weight	Approx. 150 g			
Accessories	Instruction manual, installation bracket, Four mounting brackets (M2)		Instruction manual	

* The image acquisition time does not include the image conversion processing time of the sensor controller.

Intelligent Compact Digital CMOS Cameras

Model	FZ-SQ010F	FZ-SQ050F	FZ-SQ100F	FZ-SQ100N
Image elements	CMOS color image elements (1/3-inch equivalent)			
Color/Monochrome	Color			
Effective pixels	752 (H) × 480 (V)			
Imaging area H x V (opposing corner)	4.51 × 2.88 (5.35mm)			
Pixel size	6.0 (μm) × 6.0 (μm)			
Shutter function	1/250 to 1/32,258			
Partial function	8 to 480 lines			
Frame rate (Image Acquisition Time *1)	60 fps (16.7 ms)			
Field of vision	7.5 × 4.7 to 13 × 8.2 mm	13 × 8.2 to 53 × 33 mm	53 × 33 to 240 × 153 mm	29 × 18 to 300 × 191 mm
Installation distance	38 to 60 mm	56 to 215 mm	220 to 970 mm	32 to 380 mm
LED class *2	Risk Group2			
Ambient temperature range	Operating: 0 to 50 °C Storage: -25 to 65 °C			
Ambient humidity range	Operating and storage: 35% to 85% (with no condensation)			
Weight	Approx. 150 g		Approx. 140 g	
Accessories	Mounting bracket (FQ-XL), polarizing filter attachment (FQ-XF1), instruction manual and warning label			

*1 The image acquisition time does not include the image conversion processing time of the sensor controller.

*2 Applicable standards: IEC62471-2

• Narrow View FZ-SQ010F

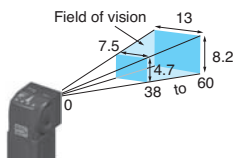

• Standard FZ-SQ050F

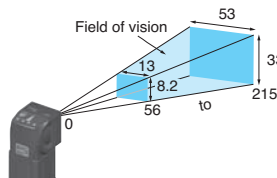

• Wide View (Long-distance) FZ-SQ100F

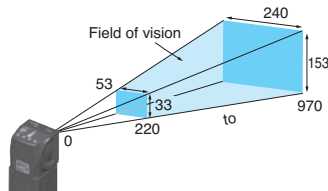

• Wide View (Short-distance) FZ-SQ100N

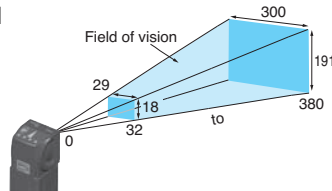

Ratings and Specifications (Cable, Monitor)

Camera Cables

Model	FZ-VS3 (2 m)	FZ-VSB3 (2 m)	FZ-VSL3 (2 m)	FZ-VSLB3 (2 m)
Type	Standard	Bend resistant	Right-angle	Bend resistant Right-angle
Shock resistiveness (durability)	10 to 150 Hz single amplitude 0.15 mm 3 directions, 8 strokes, 4 times			
Ambient temperature range	Operation and storage: 0 to 65 °C (with no icing or condensation)			
Ambient humidity range	Operation and storage: 40 to 70%RH (with no condensation)			
Ambient atmosphere	No corrosive gases			
Material	Cable sheath, connector: PVC			
Minimum bending radius	69mm	69mm	69mm	69mm
Weight	Approx. 170 g	Approx. 180 g	Approx. 170 g	Approx. 180 g

Cable Extension Unit

Model	FZ-VSJ
Power supply voltage *1	11.5 to 13.5 VDC
Current consumption *2	1.5 A max.
Ambient temperature range	Operating: 0 to 50 °C; Storage: -25 to 65 °C (with no icing or condensation)
Ambient humidity range	Operating and storage: 35 to 85% (with no condensation)
Weight	Approx. 240 g
Accessories	Instruction Sheet and 4 mounting screws

*1 A 12-VDC power supply must be provided to the Cable Extension Unit when connecting the Intelligent Compact Camera, or the Lighting Controller.

*2 The current consumption shows when connecting the Cable Extension Unit to an external power supply.

Touch Panel Monitor

Model	FH-MT12	
Major Function	Display area	12.1 inch
	Resolution	1024 (V) × 768 (H)
	Number of color	16,700,000 colors (8 bit/color)
	Brightness	500cd/m ² (Typ)
	Contrast Ratio	600:1 (Typ)
	Viewing angle	Left and right: each 80°, upward: 80°, downward: 60°
	Backlight Unit	LED, edge-light
	Backlight lifetime	About 100,000hour
External interface	Video input	analog RGB
	Touch panel signal	USB RS-232C
Ratings	Power supply voltage	24 VDC (21.6 to 26.4 VDC)
	Current consumption	0.5A
	Insulation resistance	Between DC power supply and Touch Panel Monitor FG: 20 MΩ or higher (rated voltage 250 V)
Operating environment	Ambient temperature range	Operating: 0 to 50°C, Storage: -20 to +65°C (with no icing or condensation)
	Ambient humidity range	Operating and Storage: 20 to 90 %RH (with no icing or condensation)
	Ambient environment	No corrosive gas
	Vibration resistance	10 to 150 Hz, one-side amplitude 0.1 mm (Max. acceleration 15 m/s ²) 10 times for 8 minutes for each three direction
	Degree of protection	Panel mounting: IP65 on the front
Operation	Touch pen	
Structure	Mounting	Panel mounting, VESA mounting
	Weight	Approx.2.6 kg
	Material	Front panel: PC/PBT, Front Sheet: PET, Rear case: SUS

Note: FH Series Sensor Controllers version 5.32 or higher is required.

Monitor Cables

Model	FH-VMDA (2 m)	FH-VUAB (2 m)	XW2Z-200PP-1 (2 m)
Cable type	DVI-Analog Conversion Cable	USB Cable	RS-232C Cable
Vibration resistance	10 to 150 Hz, one-side amplitude 0.1 mm, 10 times for 8 minutes for each three direction		
Ambient Temperature	Operating Condition: 0 to 50°C, Storage Condition: -10 to 60°C (with no icing or condensation)		
Ambient Humidity	Operating Condition: 35 to 85%RH, Storage Condition: 35 to 85%RH (with no icing or condensation)		
Ambient environment	No corrosive gases		
Material	Cable outer sheath, Connector: PVC		Cable outer sheath: PVC, Connector: ABS/Ni Plating
Minimum bend radius	36 mm	25 mm	59 mm
Weight	Approx.220 g	Approx.75 g	Approx.162 g

Long-distance Camera Cables

Model	FZ-VS4 (15 m)	FZ-VSL4 (15 m)
Type	Standard	Right-angle
Shock resistiveness (durability)	10 to 150 Hz single amplitude 0.15 mm 3 directions, 8 strokes, 4 times	
Ambient temperature range	Operation and storage: 0 to 65 °C (with no icing or condensation)	
Ambient humidity range	Operation and storage: 40 to 70%RH (with no condensation)	
Ambient atmosphere	No corrosive gases	
Material	Cable sheath, connector: PVC	
Minimum bending radius	78 mm	
Weight	Approx. 1400 g	

Encoder Cable

Model	FH-VR
Vibration resistiveness	10 to 150 Hz single amplitude 0.1 mm 3 directions, 8 strokes, 10 times
Ambient temperature range	Operation: 0 to 50 °C; Storage: -10 to 60 °C (with no icing or condensation)
Ambient humidity range	Operation and storage: 35 to 85%RH (with no condensation)
Ambient atmosphere	No corrosive gases
Material	Cable Jacket: Heat, oil and flame resistant PVC Connector: polycarbonate resin
Minimum bending radius	65 mm
Weight	Approx. 104 g

FH-Series

LCD Monitor

Model	FZ-M08
Size	8.4 inches
Type	Liquid crystal color TFT
Resolution	1,024 × 768 dots
Input signal	Analog RGB video input, 1 channel
Power supply voltage	21.6 to 26.4 VDC
Current consumption	Approx. 0.7 A max.
Ambient temperature range	Operating: 0 to 50 °C; Storage: -25 to 65 °C (with no icing or condensation)
Ambient humidity range	Operating and storage: 35 to 85% (with no condensation)
Weight	Approx. 1.2 kg
Accessories	Instruction Sheet and 4 mounting brackets

EtherCAT Communications Specifications

Item	Specifications	
Communications standard	IEC61158 Type 12	
Physical layer	100 BASE-TX (IEEE802.3)	
Modulation	Base band	
Baud rate	100 Mbps	
Topology	Depends on the specifications of the EtherCAT master.	
Transmission Media	Twisted-pair cable of category 5 or higher (double-shielded straight cable with aluminum tape and braiding)	
Transmission Distance	Distance between nodes: 100 m or less	
Node address setting	00 to 99	
External connection terminals	RJ45 × 2 (shielded) IN: EtherCAT input data, OUT: EtherCAT output data	
Send/receive PDO data sizes	Input	56 to 280 bytes/line (including input data, status, and unused areas) Up to 8 lines can be set. *
	Output	28 bytes/line (including output data and unused areas) Up to 8 lines can be set. *
Mailbox data size	Input	512 bytes
	Output	512 bytes
Mailbox	Emergency messages, SDO requests, and SDO information	
Refreshing methods	I/O-synchronized refreshing (DC)	

* This depends on the upper limit of the master.

Version Information

FH Series and Programming Devices

Use the latest version of Sysmac Studio Standard Edition/Vision Edition.

FH Series	Version of FH Series	Corresponding version of Sysmac Studio Standard Edition/Vision Edition
FH-5550 (-□) FH-5050 (-□) FH-2050 (-□)	Version 6.40	Supported by version 1.43* or higher.
	Version 6.31	Supported by version 1.30 or higher.
	Version 6.21	Supported by version 1.26 or higher.
	Version 6.11	Supported by version 1.25 or higher.
	Version 5.72	Supported by version 1.18 or higher.
	Version 5.71	Supported by version 1.18 or higher.
	Version 5.60	Supported by version 1.15 or higher.
	Version 5.50	Supported by version 1.14.89 or higher.
	Version 5.30	Supported by version 1.10.80 or higher.
	Version 5.20	Supported by version 1.10 or higher.
	Version 5.10	Supported by version 1.07.43 or higher.
	Version 5.00	Supported by version 1.07 or higher. Not supported by version 1.06 or lower.

* Sysmac Studio Ver.1.42 will be supported soon.

Components and Functions

Sensor Controllers
High-speed,
Large-capacity Controller
Standard Controller
(4-camera type)

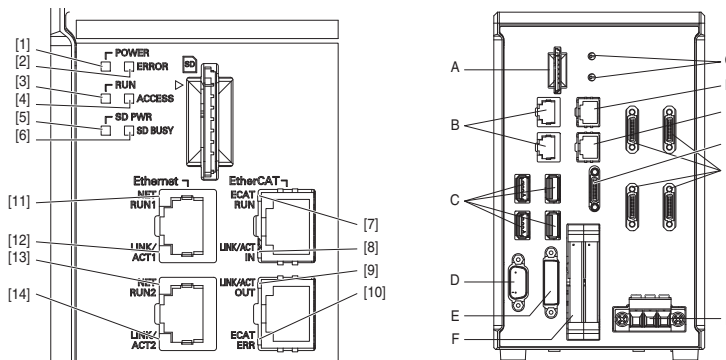

	Name	Description
[1]	POWER LED	Lit while power is ON.
[2]	ERROR LED	Lit when an error has occurred.
[3]	RUN LED	Lit while the layout turned on output setting is displayed.
[4]	ACCESS LED	Blinks while the internal nonvolatile memory is accessed.
[5]	SD POWER LED	Blinks while power is supplied to the SD memory card and the card is usable.
[6]	SD BUSY LED	Blinks while the SD memory card is accessed.
[7]	EtherCAT RUN LED	Lit while EtherCAT communications are usable.
[8]	EtherCAT LINK/ACT IN LED	Lit when connected with an EtherCAT device, and blinks while performing communications.
[9]	EtherCAT LINK/ACT OUT LED	Lit when connected with an EtherCAT device, and blinks while performing communications.
[10]	EtherCAT ERR LED	Lit when EtherCAT communications have become abnormal.
[11]	EtherNet NET RUN1 LED	Lit while EtherNet communications are usable.
[12]	EtherNet LINK/ACK1 LED	Lit when connected with an EtherNet device, and blinks while performing communications.
[13]	EtherNet NET RUN2 LED	Lit when EtherNet communications are usable.
[14]	EtherNet LINK/ACK2 LED	Lit when connected with an EtherNet device, and blinks while performing communications.

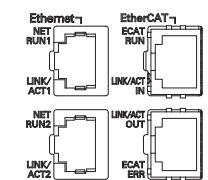
	Name	Description
A	SD memory card installation connector	Install the SD memory card. Do not plug or unplug the SD memory card during measurement operation. Otherwise measurement time may be affected or data may be destroyed.
B	EtherNet connector	Connect an EtherNet device. <div style="border: 1px solid black; padding: 5px; margin: 5px 0;"> <p style="text-align: center;">FH-2050 Series/FH-5□50 Series</p> <p>Upper port: Ethernet port</p> <p>Lower port: Ethernet port, EtherNet/IP port, and PROFINET port are sharing use.</p>  </div>
C	USB connector	Connect a USB device. Do not plug or unplug it during measurement operation. Otherwise measurement time may be affected or data may be destroyed.
D	RS-232C connector	Connect an external device such as a programmable controller.
E	DVI-I connector	Connect a monitor.
F	I/O connector (control lines, data lines)	Connect the controller to external devices such as a sync sensor and PLC.
G	EtherCAT address setup volume	Used to set a node address (00 to 99) as an EtherCAT communication device.
H	EtherCAT communication connector (IN)	Connect the opposed EtherCAT device.
I	EtherCAT communication connector (OUT)	Connect the opposed EtherCAT device.
J	Encoder connector	Connect an encoder.
K	Camera connector	Connect cameras.
L	Power supply terminal connector	Connect a DC power supply. Wire the controller independently on other devices. Wire * the ground line. Be sure to ground the controller alone.

* Use the attachment power terminal connector (male) of FH-XCN series. For details, refer to 5-3 Sensor Controller Installation on Vision System FH/FZ5 series Hardware Setup Manual (Z366).

Lite Controllers (4-camera type)

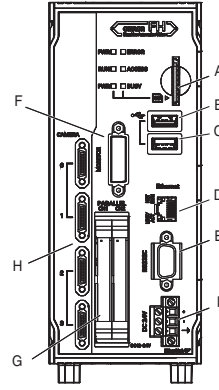
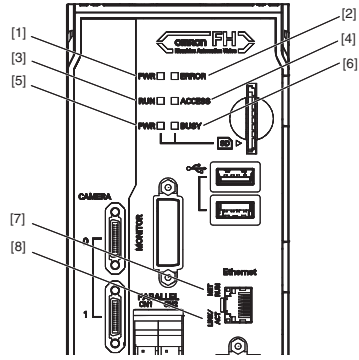

	LED name	Description
[1]	PWR LED	Lit while power is ON.
[2]	ERROR LED	Lit when an error has occurred.
[3]	RUN LED	Lit while the layout turned on output setting is displayed.
[4]	ACCESS LED	Blinks while the internal nonvolatile memory is accessed.
[5]	SD PWR LED	Lit while power is supplied to the SD memory card and the card is usable.
[6]	SD BUSY LED	Lit when access to the SD memory card.
[7]	Ethernet NET RUN LED	Lit while Ethernet communications are usable.
[8]	Ethernet LINK/ACT LED	Blinks when connected with an Ethernet device, and blinks while performing communications.

	Connector name	Description
A	SD memory card installation connector	Install the SD memory card. Do not plug or unplug the SD memory card during measurement operation. Otherwise measurement time may be affected or data may be destroyed.
B	USB 2.0 connector	Connects to USB 2.0. Do not insert or remove during loading or writing of measurement or data. The measurement time can be longer or data can be damaged.
C	USB 3.0 connector	Connects to USB 3.0. Do not insert or remove during loading or writing of measurement or data. The measurement time can be longer or data can be damaged. USB 3.0 has a high ability to supply the bus power. Use the Sensor Controller by combining USB 3.0, faster transport can be realized.
D	Ethernet connector	Connect an Ethernet device. Ethernet port, EtherNet/IP port, and PROFINET port are sharing use.
E	RS-232C connector	Connect an external device such as a programmable controller.
F	DVI-I connector	Connect a monitor.
G	Parallel connector (control lines, data lines)	Connect the controller to external devices such as a sync sensor.
H	Camera connector	Connect a camera.
I	Power supply terminal connector	Connect a DC power supply. Wire the controller independently on other devices. Wire * the ground line. Be sure to ground the FH Sensor Controller alone.

* Use the attachment power terminal connector (male) of FH-XCN-L series.
For details, refer to 5-3 Sensor Controller Installation on Vision System FH/FZ5 series Hardware Setup Manual(Z366).

Processing Items

Group	Icon	Processing Item	Corresponding Page in the Catalog
Measurement		Search Used to identify the shapes and calculate the position of measurement objects.	
		Flexible Search Recognizing the shapes of workpieces with variation and detecting their positions.	
		Sensitive Search Search a small difference by dividing the search model in detail, and calculating the correlation.	
		ECM Search Used to search the similar part of model form input image. Detect the evaluation value and position.	
		EC Circle Search Extract circles using "round" shape information and get position, radius and quantity in high preciseness.	
		Shape Search II Used to search the similar part of model from input image regardless of environmental changes. Detect the evaluation value and position.	
		Shape Search III Robust detection of positions is possible at high-speed and with high precision incorporating environmental fluctuations, such as differences in individual shapes of the workpieces, pose fluctuations, noise superimposition and shielding.	P12
		EC Corner This processing item measures a corner position (corner) of a workpiece.	
		Ec Cross The center position of a crosshair shape is measured using the lines created by the edge information on each side of the crosshair.	
		Classification Used when various kinds of products on the assembly line need to be sorted and identified.	
		Edge Position Measure position of measurement objects according to the color change in measurement area.	
		Edge Pitch Detect edges by color change in measurement area. Used for calculating number of pins of IC and connectors.	
		Scan Edge Position Measure peak/bottom edge position of workpieces according to the color change in separated measurement area.	P12
		Scan Edge Width Measure max/min/average width of workpieces according to the color change in separated measurement area.	
		Circular Scan Edge Position Measure center axis, diameter and radius of circular workpieces.	P12
		Circular Scan Edge Width Measure center axis, width and thickness of ring workpieces.	
		Intersection Calculate approximate lines from the edge information on two sides of a square workpiece to measure the angle formed at the intersection of the two lines.	
		Color Data Used for detecting presence and mixed varieties of products by using color average and deviation.	
		Gravity and Area Used to measure area, center of gravity of workpieces by extracting the color to be measured.	
		Labeling Used to measure number, area and gravity of workpieces by extracting registered color.	
		Label Data Selecting one region of extracted Labeling, and get that measurement. Area and Gravity position can be got and judged.	
		Defect Used for appearance measurement of plain-color measurement objects such as defects, stains and burrs.	
		Precise Defect Check the defect on the object. Parameters for extraction defect can be set precisely.	
		Fine Matching Difference can be detected by overlapping and comparing (matching) registered fine images with input images.	
		Character Inspect Recognize character according correlation search with model image registered in [Model Dictionary].	P15
		Date Verification Reading character string is verified with internal date.	
		Model Dictionary Register character pattern as dictionary. The pattern is used in [Character Inspection].	
		2DCode II *1 Recognize 2D code and display where the code quality is poor.	P15
		2DCode *2 Recognize 2D code and display where the code quality is poor.	
		Barcode *3 Recognize barcode, verify and output decoded characters.	
		OCR Recognize and read characters in images as character information.	P15
		OCR User Dictionary Register dictionary data to use for OCR.	
	Circle Angle Used for calculating angle of inclination of circular measurement objects.		

Group	Icon	Processing Item	Corresponding Page in the Catalog
Measurement		Glue Bead Inspection You can inspect coating of a specified color for gaps or runoffs along the coating path.	
		AI FineMatching *4 Performs learning with "non-defective" product images and detects the difference between the input image and the non-defective image. Allows for variations in non-defective products and detects only defects.	P6
Input Image		Camera Image Input FH To input images from cameras. And set up the conditions to input images from cameras. (For FH Sensor Controllers only)	
		Camera Image Input HDR Create high-dynamic range images by acquiring several images with different conditions.	P10
		Camera Image Input HDRLite HDR function for FZ-SQ Intelligent Compact Cameras.	
		Photometric Stereo Image Input Capture images under different illumination directions using a photometric stereo light.	
		Camera Switch To switch the cameras used for measurement. Not input images from cameras again.	
		Measurement Image Switching To switch the images used for measurement. Not input images from camera again.	
		Multi-trigger Imaging The Multi-trigger Imaging processing item captures multiple images at user-defined timings and executes parallel measurement for each image. Insert the Multi-trigger imaging to the top of the flow.	P10
		Multi-trigger Imaging Task The Multi-trigger Imaging processing item captures multiple images at user-defined timings and executes parallel measurement for each image. Insert this processing item to the top of the processing which requires imaging for multiple times.	
		Position Compensation Used when positions are differed. Correct measurement is performed by correcting position of input images.	
		Filtering Used for processing images input from cameras in order to make them easier to be measured.	
Compensate image		Background Suppression To enhance contrast of images by extracting color in specified brightness.	
		Brightness Correct Filter Track brightness change of entire screen and remove gradual brightness change such as uneven brightness.	
		Color Gray Filter Color image is converted into monochrome images to emphasize specific color.	
		Extract Color Filter Convert color image to color extracted image or binary image.	
		Anti Color Shading To remove the irregular color/pattern by uniformizing max.2 specified colors.	
		Stripes Removal Filter II Remove the background pattern of vertical, horizontal and diagonal stripes.	
		Polar Transformation Rectify the image by polar transformation. Useful for OCR or pattern inspection printed on circle.	
		Trapezoidal Correction Rectify the trapezoidal deformed image.	
		Machine Simulator How the alignment marks would move on the image when each stage or robot axis is controlled can be checked.	
		Image Subtraction The registered model image and measurement image are compared and only the different pixels are extracted and converted to an image.	
		Advanced filter Process the images acquired from cameras in order to make them easier to measure. This processing item consolidates existing image conversion filtering into one processing item and adds extra functions.	
		Panorama Combine multiple image to create one big image.	
		AI Scratch Detect Filter *5 Extracts defects in the set measurement area.	P4
	Support measurement		Unit Macro Advanced arithmetic processing can be easily incorporated into workflow as Unit Macro processing items.
		Unit Calculation Macro This function is convenient when the user wants to calculate a value using an original calculation formula or change the set value or system data of a processing item.	
		Calculation Used when using the judge results and measured values of ProcItem which are registered in processing units.	
		Line Regression Used for calculating regression line from plural measurement coordinate.	
		Circle Regression Used for calculating regression circle from plural measurement coordinate.	
		Precise Calibration Used for calibration corresponding to trapezoidal distortion and lens distortion.	

Group	Icon	Processing Item	Corresponding Page in the Catalog	
Support measurement		User Data	Used for setting of the data that can be used as common constants and variables in scene group data.	
		Set Unit Data	Used to change the Procltem data (setting parameters, etc.) that has been set up in a scene.	
		Get Unit Data	Used to get one data (measured results, setting parameters, etc.) of Procltem that has been set up in a scene.	
		Set Unit Figure	Used for re-setting the figure data (model, measurement area) registered in an unit.	
		Get Unit Figure	Used for get the figure data (model, measurement area) registered in an unit.	
		Trend Monitor	Used for displaying the information about results on the monitor, facilitating to avoid NG and analyze causes.	
		Image Logging	Used for saving the measurement images to the memory and USB memory.	
		Image Conversion Logging	Used for saving the measurement images in JPEG and BMP format.	
		Data Logging	Used for saving the measurement data to the memory and USB memory.	
		Elapsed Time	Used for calculating the elapsed time since the measurement trigger input.	
		Wait	Processing is stopped only at the set time. The standby time is set by the unit of [ms].	
		Focus	Focus setting is supported.	
		Iris	Focus and aperture setting is supported.	
		Parallelize	A part of the measurement flow is divided into two or more tasks and processed in parallel to shorten the measurement time. This processing item is placed at the top of processing to be performed in parallel.	
		Parallelize Task	A part of the measurement flow is divided into two or more tasks and processed in parallel to shorten the measurement time. This processing item is placed immediately before processing to be performed in parallel between Parallelize and Parallelize End.	
		Statistics	Used when you need to calculate an average of multiple measurement results.	
		Reference Calib Data	Calibration data and distortion compensation data held under other processing items can be referenced.	
		Position Data Calculation	The specified position angle is calculated from the measured positions.	
		Stage Data	Sets and stores data related to stages.	P13
		Robot Data	Sets and stores data related to robots.	
		Vision Master Calibration	This processing item automatically calculates the entire axis movement amount of the control equipment necessary for calibration.	
		PLC Master Calibration	Calibration data is created using a communication command from PLC.	
		Convert Position Data	The position angle after the specified axis movement is calculated.	
		Movement Single Position	The axis movement that is required to match the measured position angle to the reference position angle is calculated.	
		Movement Multi Points	The axis movements that are required to match the measured position angles to the corresponding reference position angles are calculated.	
		Detection Point	Obtains position/angle information by referring to the coordinate values measured with the Measurement Processing Unit.	
		Manual Position Setting	Used to change the measurement coordinates X and Y of the measurement processing unit.	
		Camera Calibration	By setting the camera calibration, the measurement result can be converted and output as actual dimensions.	
		Data Save	The set data can be saved in the controller main unit or as scene data. The data is held even after the FH/FZ power is turned off.	
		Conveyor Calibration	Conveyor Calibration is used to calibrate camera, conveyor, and robots for conveyor or tracking application.	
		Scene	The specified scene is copied to the current scene.	
		System Information	Obtain system information (e.g., memory and disk space and I/O input signal status) of the Sensor Controller.	

Group	Icon	Processing Item	Corresponding Page in the Catalog
Branch		Conditional Branch	Used where more than two kinds of products on the production line need to detected separately.
		End	This Procltem must be set up as the last processing unit of a branch.
		DI Branch	Same as Procltem "Branch". But you can change the targets of conditional branching via external inputs.
		Control Flow Normal	Set the measurement flow processing into the wait state in which the specific no-protocol command can be executed.
		Control Flow PLC Link	Set the measurement flow processing into the wait state in which the specific PLC Link command can be executed.
		Control Flow Parallel	Set the measurement flow processing into the wait state in which the specific parallel command can be executed.
		Control Flow Fieldbus	Set the measurement flow processing into the wait state in which the specific Fieldbus command can be executed.
		Selective Branch	Easily branch to multiple destinations.
		Conditional Execution (If)	The measurement flow is divided according to the comparison result obtained using the set expressions and conditions.
		Conditional Execution (Else)	Insert between the Conditional Execution (If) processing item and End If processing item. The measurement flow is divided according to the comparison result obtained using the set expressions and conditions.
		Loop	The set processes are repeated until the loop count reaches the specified number, and then the next process starts.
		Loop Suspension	Insert between the Loop processing item and End Loop processing item. Used to stop the loop before the loop count reaches the specified number.
		Select Execution (Select)	Used to set conditions. The measurement flow is divided according to the comparison result obtained using the conditions given by expressions.
		Select Execution (Case)	Used to make a judgment. The measurement flow is divided according to the comparison result obtained using the conditions given by expressions.
Output result		Result Output (I/O)	Output data to the external devices such as a programmable controller or a PC via PLC Link, Parallel interface, Fieldbus interface (EtherCAT, EtherNet/IP (other than message communication), PROF-INET).
		Result Output (Message)	Output data to the external devices such as a programmable controller or a PC with non-procedure mode via the serial interface or EtherNet/IP (message communication). This processing item allows you to save the logging data as a ".csv" file into the Sensor Controller as well.
		Data Output	Used when you need to output data to the external devices such as PLC or PC via serial ports.
		Parallel Data Output	Used when you need to output data to the external devices such as PLC or PC via parallel ports.
		Parallel Judgement Output	Used when you need to output judgement results to the external devices such as PLC or PC via parallel ports.
		Fieldbus Data Output	Outputs data to an external device, such as a Programmable Controller, through a fieldbus interface.
		Result Display	Used for displaying the texts or the figures in the camera image.
		Display Image File	Display selected image file.
		Display Last NG Image	Display the last NG images.
		Conveyor Panorama Display	Display images of the tracking area as a panoramic image.
Display result		Display Image Hold	Processing item to retain images, including measurement results.

- *1 2D Codes that can be read : Data Matrix (ECC200)
- *2 2D Codes that can be read : Data Matrix (ECC200), QR Code
- *3 Bar Codes that can be read : JAN/EAN/UPC (including add-on codes), Code 39, Codabar (NW-7), ITF (Interleaved 2 of 5), Code 93, Code 128, GS1-128, GS1 DataBar (RSS-14 / RSS Limited / RSS Expanded), Pharmacode
- *4 Available on the FH-5□50-series Controller (version 6.40 or later).
- *5 Available on the FH-5□50-series Controller (version 6.40 or later). Optional FH-UMAI1 Scratch Detect AI Software Installer is required.

Dimensions

Sensor Controllers

High-speed, Large-capacity Controllers/Standard Controllers

FH-5550/-5550-10/-5550-20

FH-5050/-5050-10/-5050-20

FH-2050/-2050-10/-2050-20

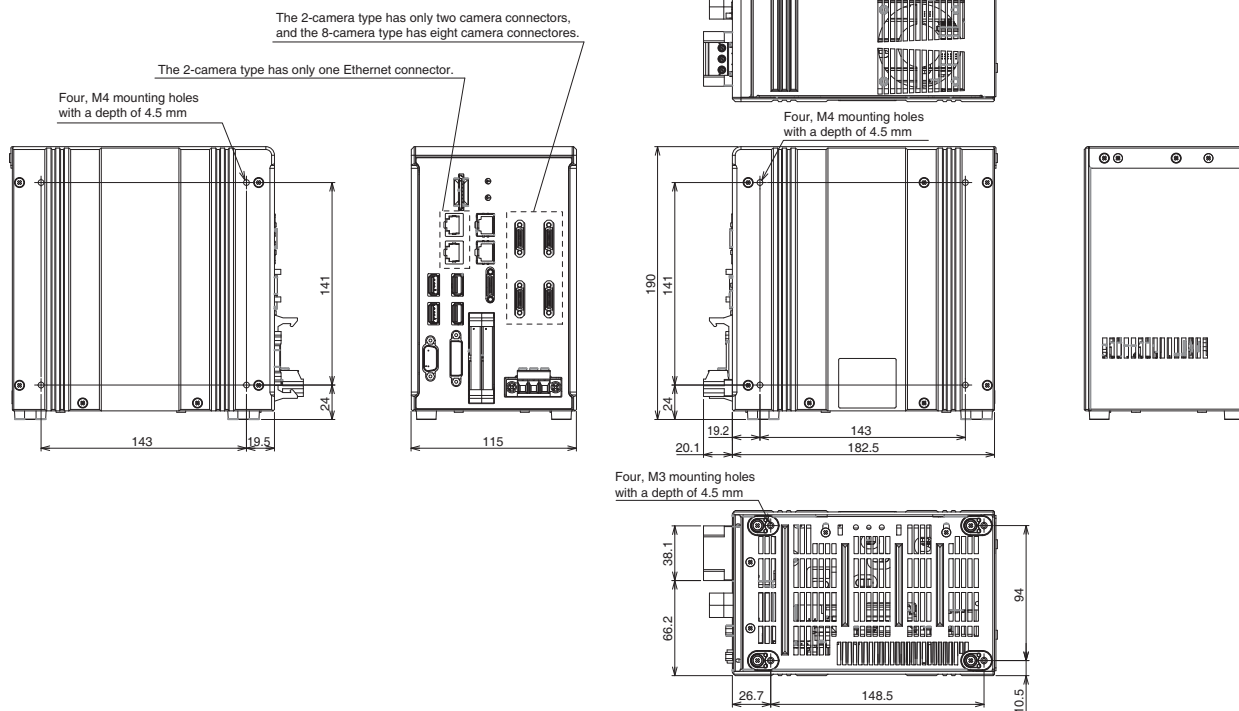

Lite Controllers

FH-L550/-L550-10

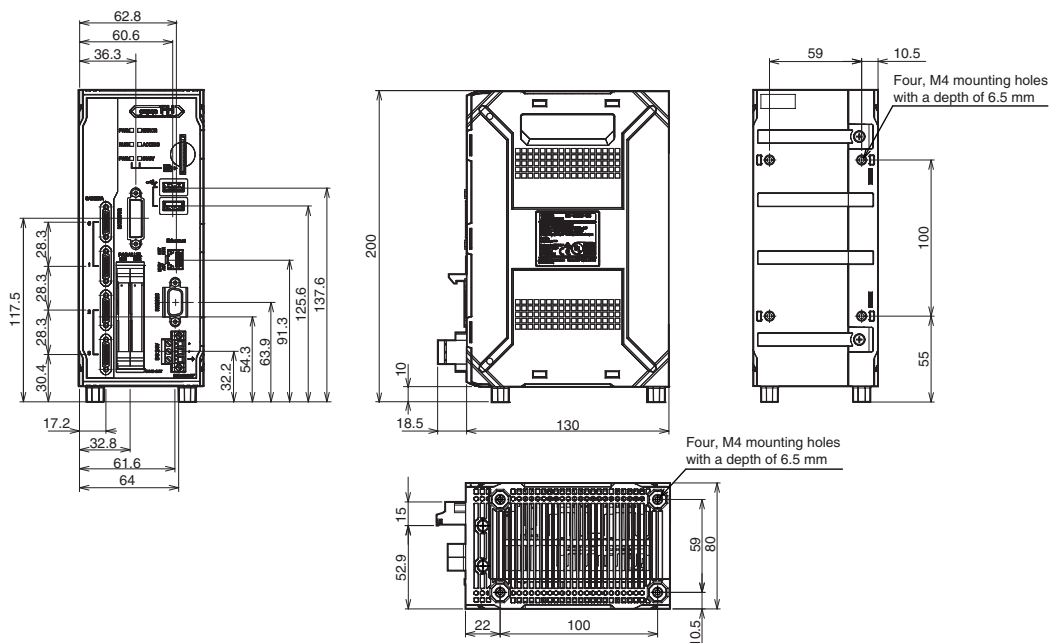

Cameras

High-speed Digital CMOS Camera/Digital CMOS Camera

300,000-pixel camera

FH-SC
FH-SM

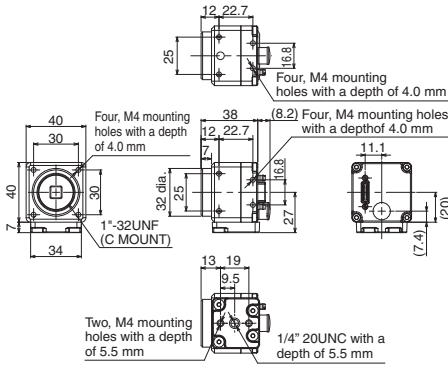

400,000-pixel camera

FH-SCX
FH-SMX

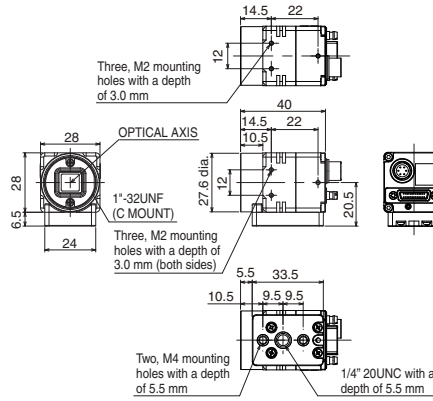

2 million-pixel camera

FH-SC02
FH-SM02

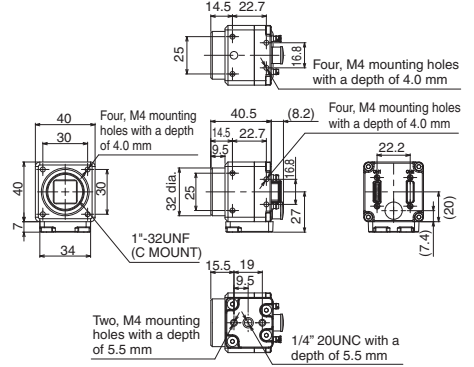

4 million-pixel camera

FH-SC04
FH-SM04

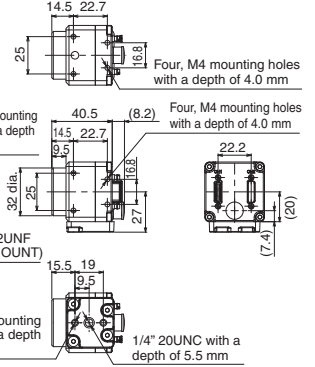

5 million-pixel camera

FH-SM05R
FH-SC05R

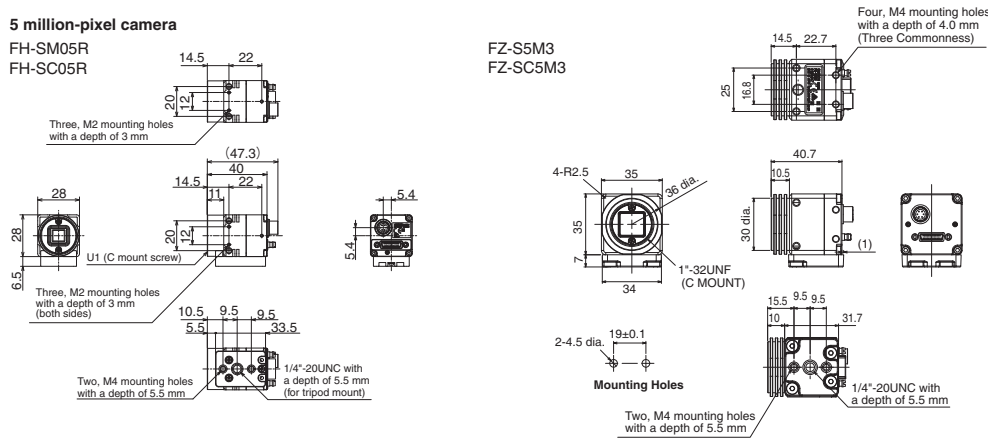

FZ-S5M3
FZ-SC5M3

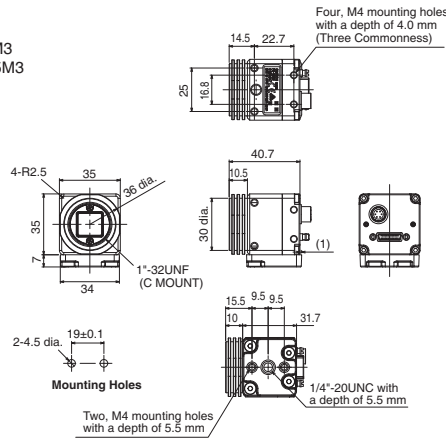

5 million-pixel camera

FH-SCX05
FH-SMX05

12 million-pixel camera

FH-SCX12
FH-SMX12

20.4 million-pixel camera

FH-SC21R
FH-SM21R

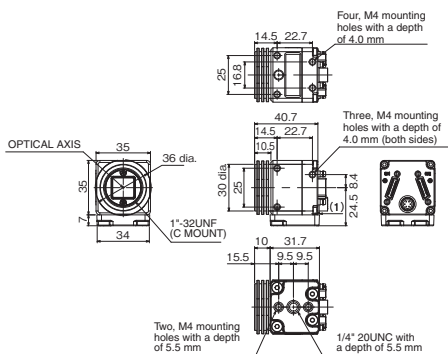

12 million-pixel camera

FH-SC12
FH-SM12

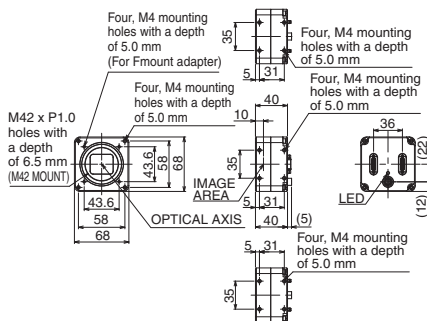

Cables

Camera Cable

Camera Cable

FZ-VS3

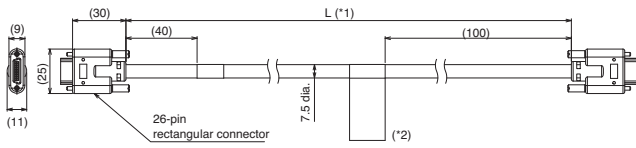

Bend resistant Camera Cable

FZ-VSB3

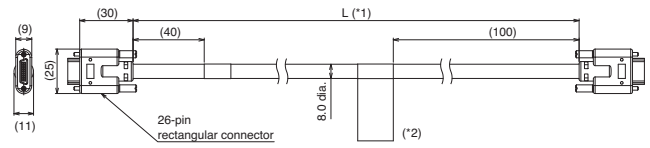

Right-angle Camera Cable

FZ-VSL3

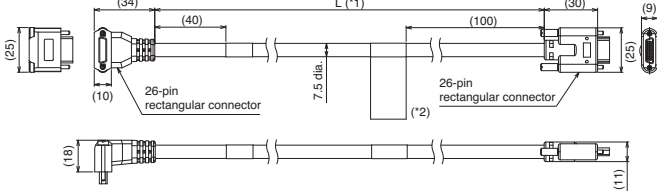

Bend resistant Right-angle Camera Cable

FZ-VSLB3

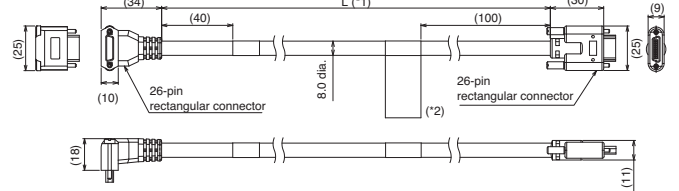

Long-distance Camera Cable

FZ-VS4

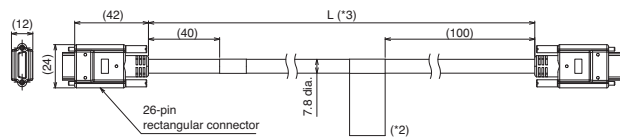

Long-distance Right-angle Camera Cable

FZ-VSL4

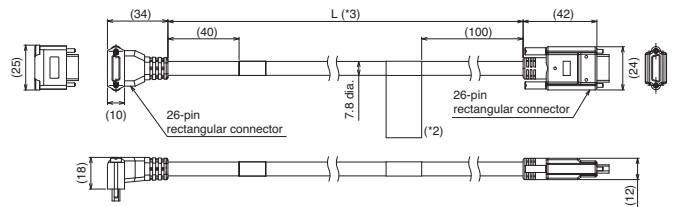

- *1. Cable is available in 2m/3m/5m/10m.
- *2. Each camera cables has polarity. Please ensure that the name plate side of the cable is connected to the controller.
- *3. Cable is available in 15m.

Camera Cable Extension Unit

FZ-VS3J

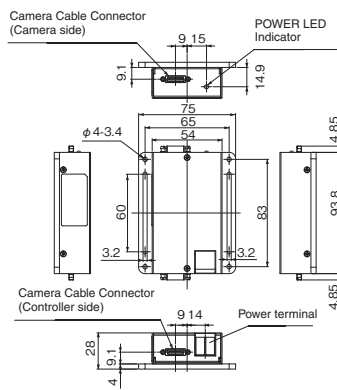

Extension Tubes for Small Camera

FZ-LESR

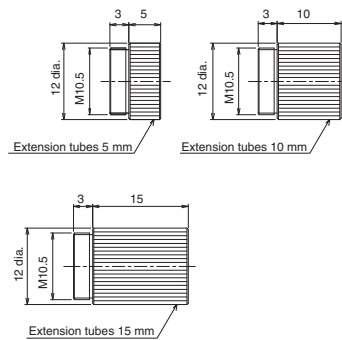

Lens for Small Camera

FZ-LES Series

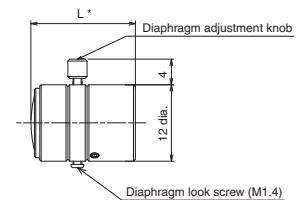

* Overall length is available in 16.4mm/19.7mm/23.1mm/25.5mm.

Encoder Cable

FH-VR

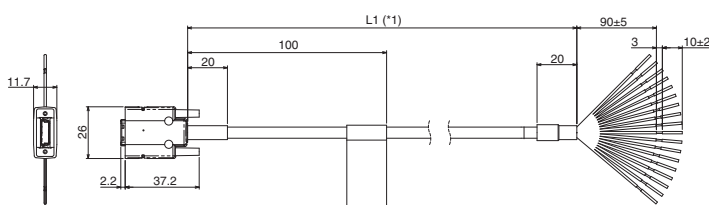

*1. Cable is available in 1.5 m.

Parallel I/O Cable

XW2Z-S013-□

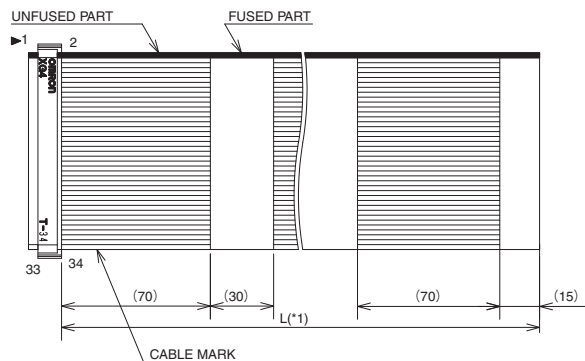

*1. Cable is available in 2m/5m.

Touch Panel Monitor

FH-MT12

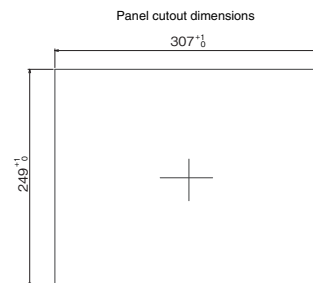
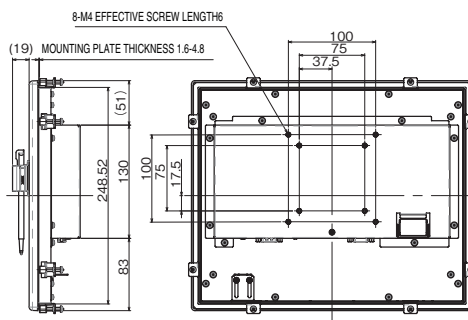
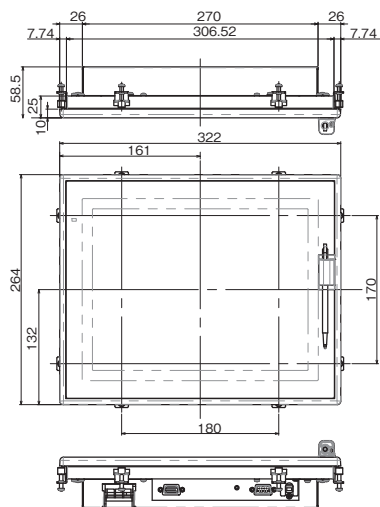

Note:1. Panel thickness : 1.6 to 4.8 mm
2. No burr allowed

DVI-Analog Conversion Cable for Touch Panel Monitor/LCD Monitor

FH-VMDA

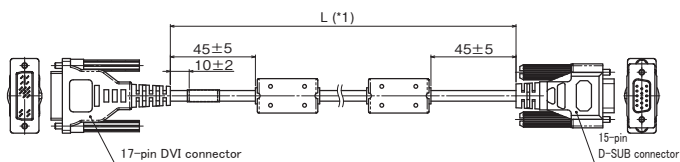

RS-232C Cable for Touch Panel Monitor

XW2Z-□□□PP-1

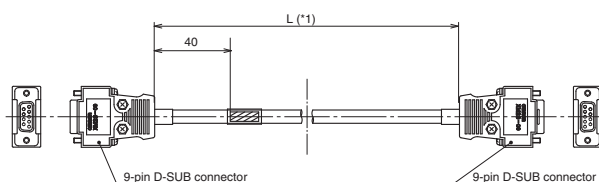

USB Cable for Touch Panel Monitor

FH-VUAB

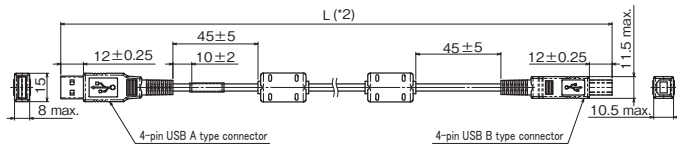

*1. Cable is available in 2m/5m/10m.
*2. Cable is available in 2m/5m.

LCD Monitor

FZ-M08

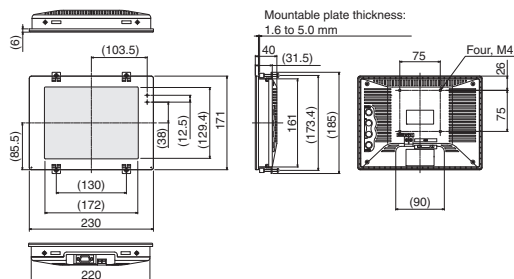

FH-Series

Optical Chart

Meaning of Optical Chart

The X axis of the optical chart shows the field of vision (mm) (*1), and the Y axis of the optical chart shows the camera installation distance (mm) (*2).

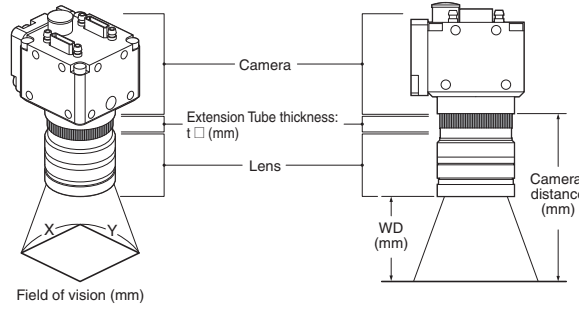

*1. The lengths of the fields of vision given in the optical charts are the lengths of the Y axis.
*2. The vertical axis represents WD for small cameras.

Standard Lenses

Small Digital CCD Cameras

FZ-SF□,

FZ-SP□

300,000-pixel

(Using FZ-LES Series)

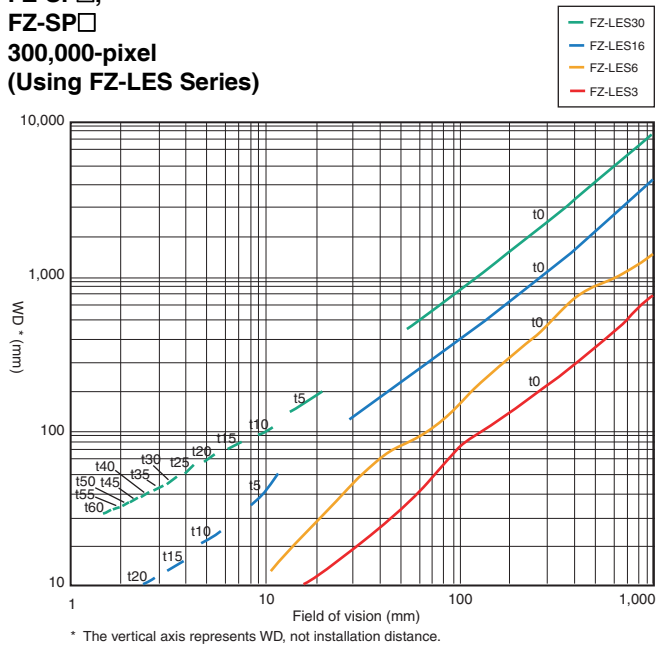

* The vertical axis represents WD, not installation distance.

High-speed Digital CMOS Camera FH-S□, Digital CCD Camera FZ-S□ 300,000-pixel (Using 3Z4S-LE SV-V Series)

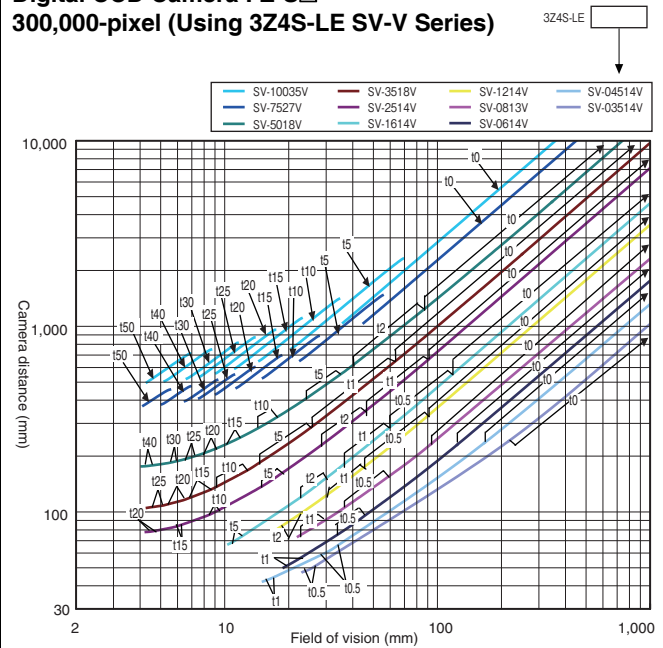

High-speed Digital CMOS Camera FH-S□X

400,000-pixel

(Using 3Z4S-LE SV-V Series)

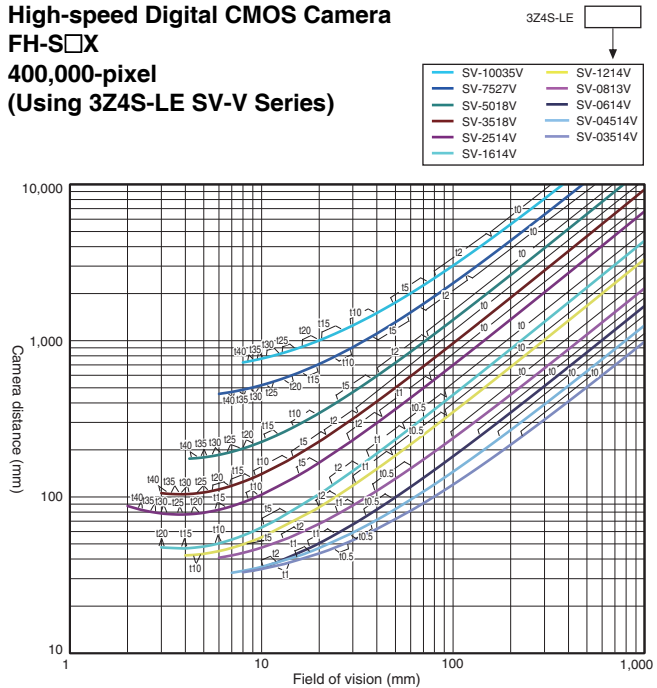

Digital CCD Camera FZ-S□2M

2 million-pixel

(Using 3Z4S-LE SV-H Series)

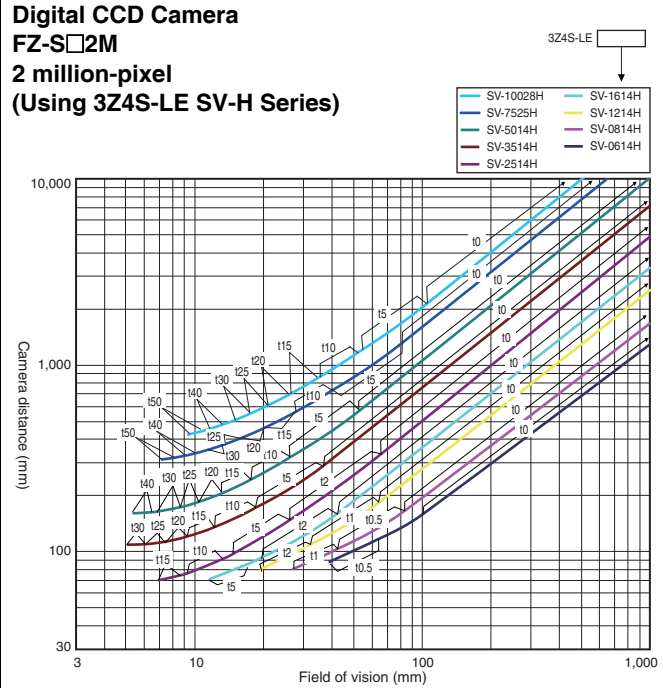

High-speed Digital CMOS Camera
FH-S□02
 2 million-pixel
 (Using 3Z4S-LE SV-H/VS-H1 Series)

3Z4S-LE

- SV-10028H
- SV-7525H
- VS-5018H1
- VS-3514H1
- VS-2514H1
- VS-1614H1N
- VS-1214H1
- VS-0814H1
- VS-0618H1

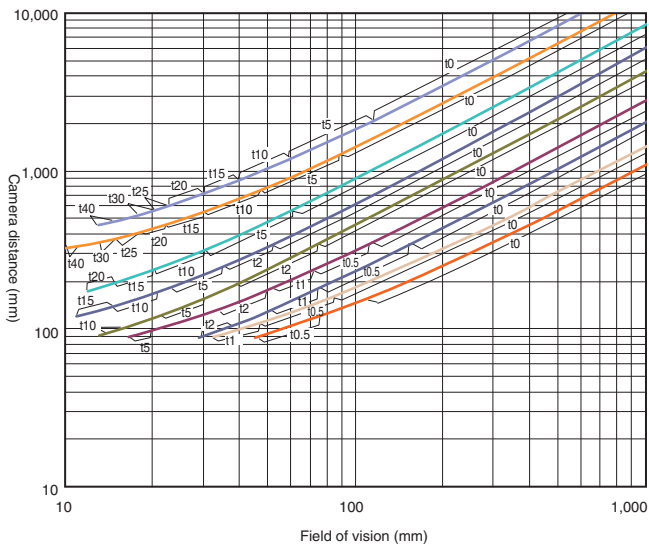

High-speed Digital CMOS Camera
FH-S□04
 4 million-pixel
 (Using 3Z4S-LE SV-H/VS-H1 Series)

3Z4S-LE

- SV-10028H
- SV-7525H
- VS-5018H1
- VS-3514H1
- VS-2514H1
- VS-1614H1N
- VS-1214H1
- VS-0814H1
- VS-0618H1

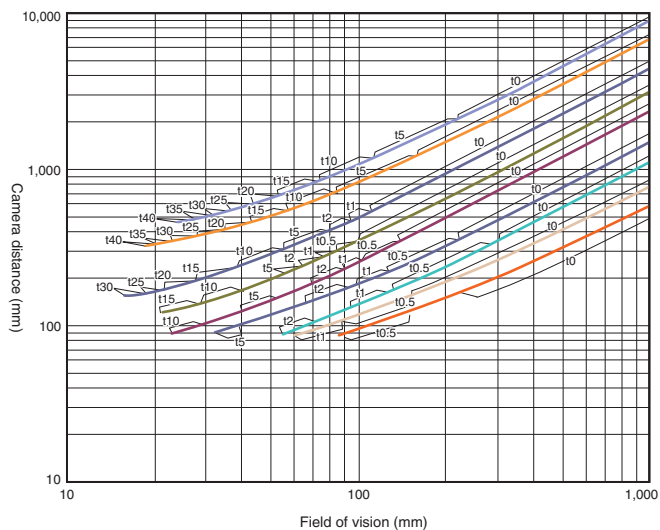

Digital CMOS Camera
FH-S□05R
 5 million-pixel
 (Using 3Z4S-LE SV-H Series)

3Z4S-LE

- SV-10028H
- SV-7525H
- SV-5014H
- SV-3514H
- SV-2514H
- SV-1614H
- SV-1214H
- SV-0814H
- SV-0614H

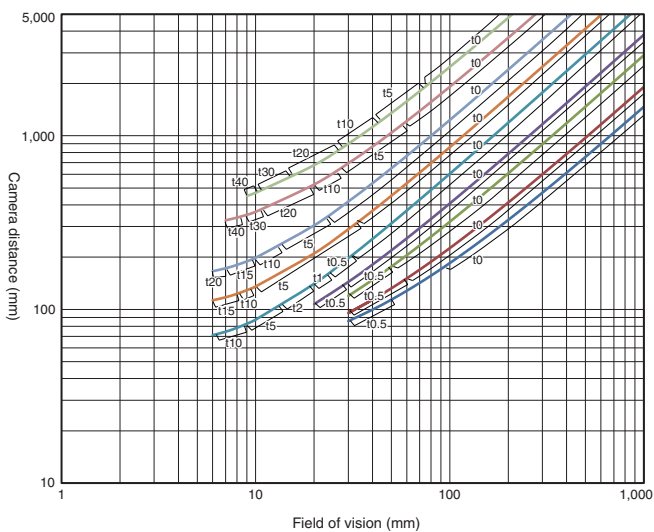

Digital CMOS Camera FZ-S□5M3,
High-speed Digital CMOS Camera
FH-S□X05
 5 million-pixel
 (Using 3Z4S-LE SV-H Series)

3Z4S-LE

- SV-10028H
- SV-7525H
- SV-5014H
- SV-3514H
- SV-2514H
- SV-1614H
- SV-1214H
- SV-0814H
- SV-0614H

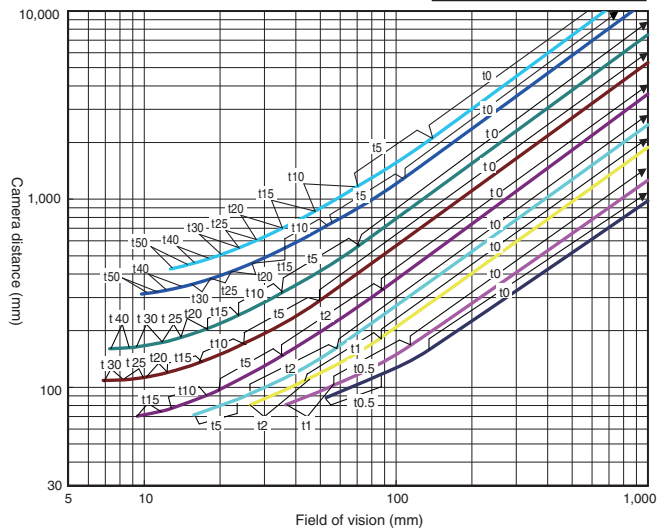

High-speed Digital CMOS Camera FH-S□X12 12 million-pixel (Using 3Z4S-LE VS-LLD Series)

Note: The 3Z4S-LE VS-LDD Series cannot be used with an extension tube.

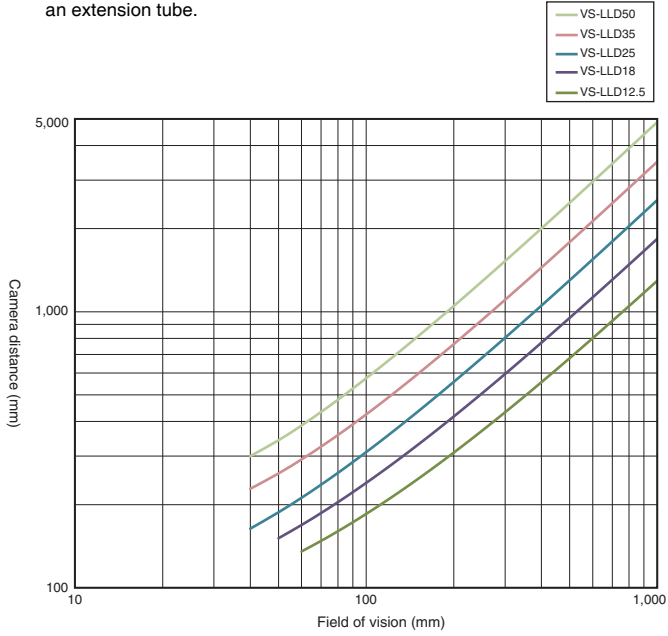

High-speed Digital CMOS Camera FH-S□12 12 million-pixel (Using 3Z4S-LE VS-L/M42-10 Series)

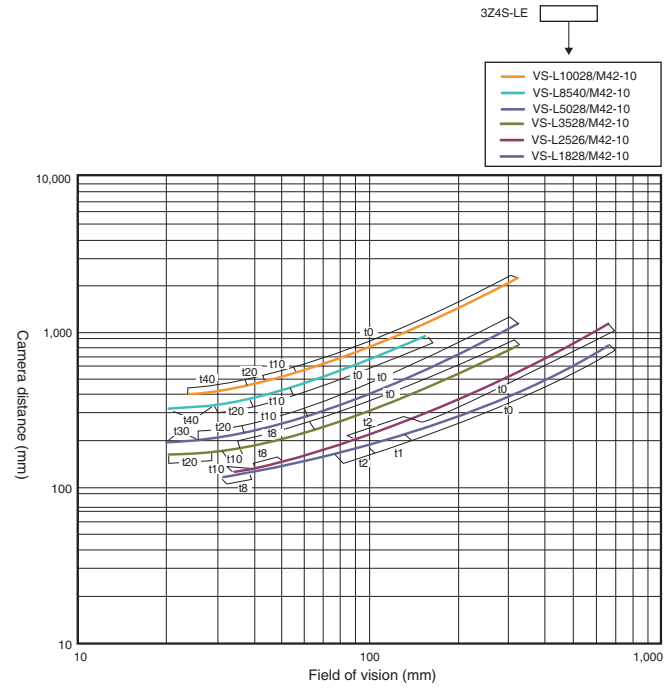

Digital CMOS Camera FH-S□21R 20.4 million-pixel (Using 3Z4S-LE VS-LLD Series)

Note: The 3Z4S-LE VS-LDD Series cannot be used with an extension tube.

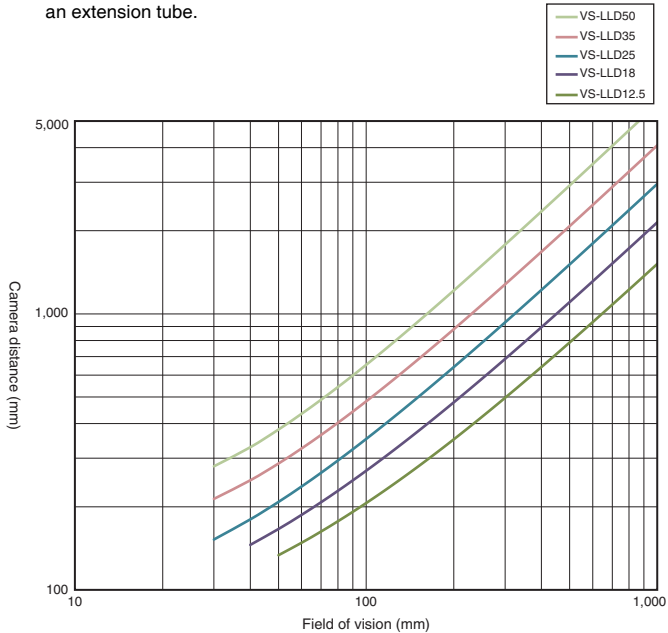

Vibrations and Shocks Resistant Lenses/Telecentric Lenses

High-speed Digital CMOS Camera
 FH-S□,
 Digital CCD Camera
 FZ-S□
 300,000-pixel
 (Using 3Z4S-LE VS-MCA Series)

3Z4S-LE □

- VS-MCA75
- VS-MCA50
- VS-MCA35
- VS-MCA30
- VS-MCA25
- VS-MCA20
- VS-MCA15

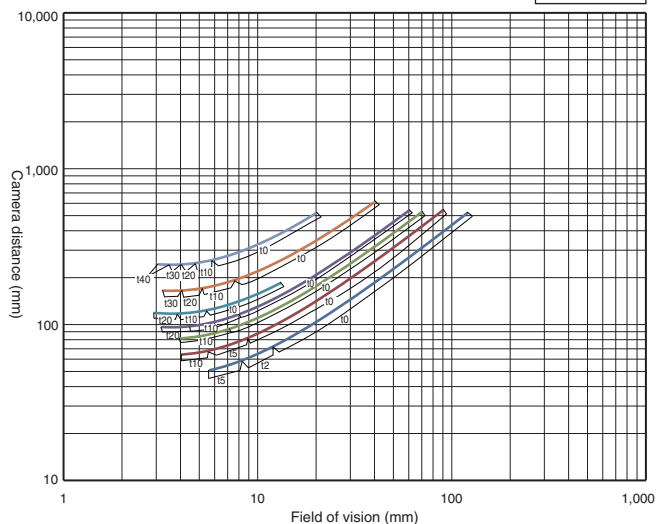

High-speed Digital CMOS Camera
 FH-S□X
 400,000-pixel
 (Using 3Z4S-LE VS-MCA Series)

3Z4S-LE □

- VS-MCA75
- VS-MCA50
- VS-MCA35
- VS-MCA30
- VS-MCA25
- VS-MCA20
- VS-MCA15

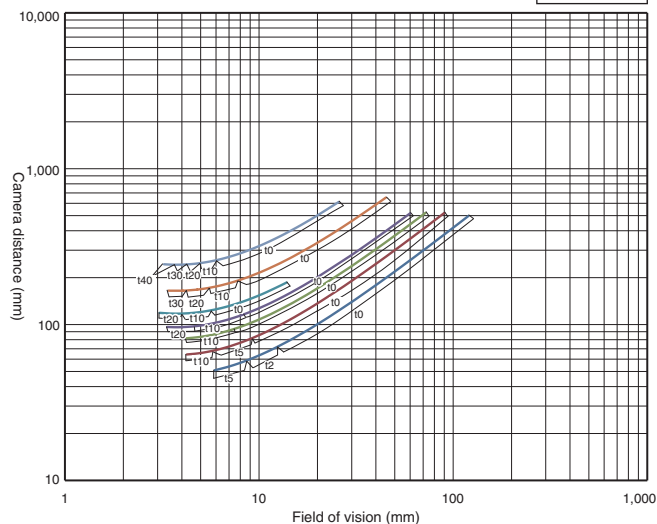

Digital CCD Camera
 FZ-S□2M
 2 million-pixel
 (Using 3Z4S-LE VS-MCA Series)

3Z4S-LE □

- VS-MCA75
- VS-MCA50
- VS-MCA35
- VS-MCA30
- VS-MCA25
- VS-MCA20
- VS-MCA15

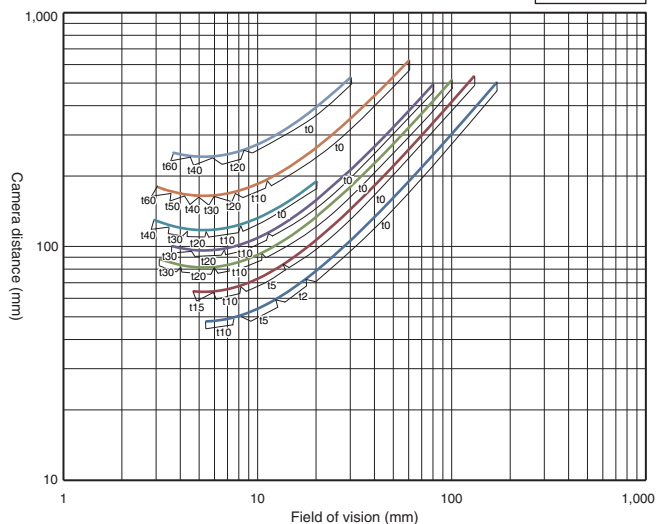

High-speed Digital CMOS Camera
 FH-S□02
 2 million-pixel
 (Using 3Z4S-LE VS-MCH1 Series)

3Z4S-LE □

- VS-MC50H1
- VS-MC35H1
- VS-MC25H1
- VS-MC16H1
- VS-MC12H1
- VS-MC08H1

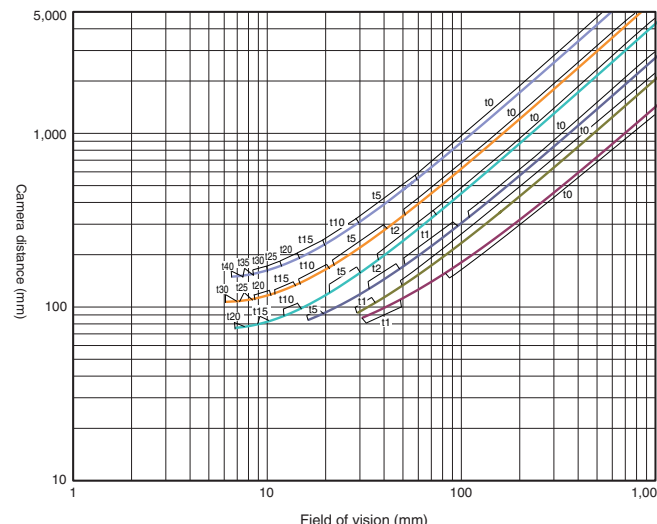

FH-Series

High-speed Digital CMOS Camera FH-S□04 4 million-pixel (Using 3Z4S-LE VS-MCH1 Series)

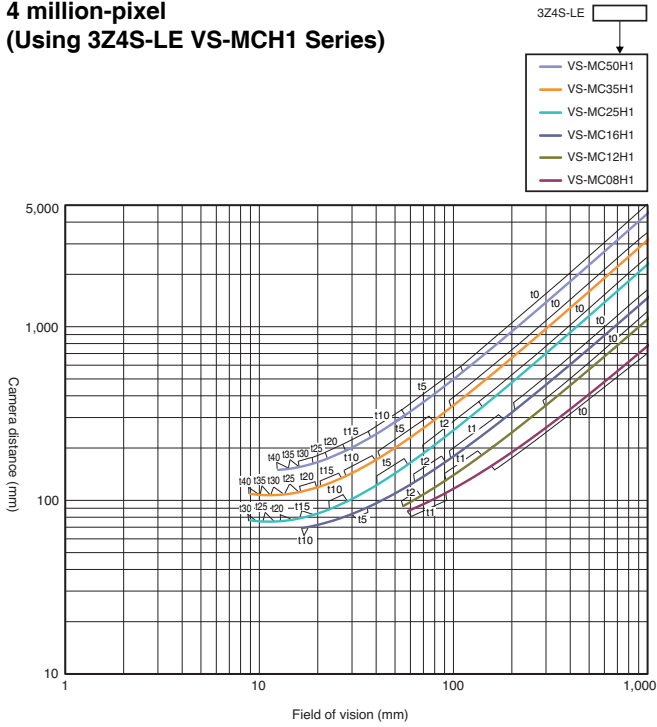

Digital CMOS Camera FH-S□05R 5 million-pixel (Using 3Z4S-LE VS-MCA Series)

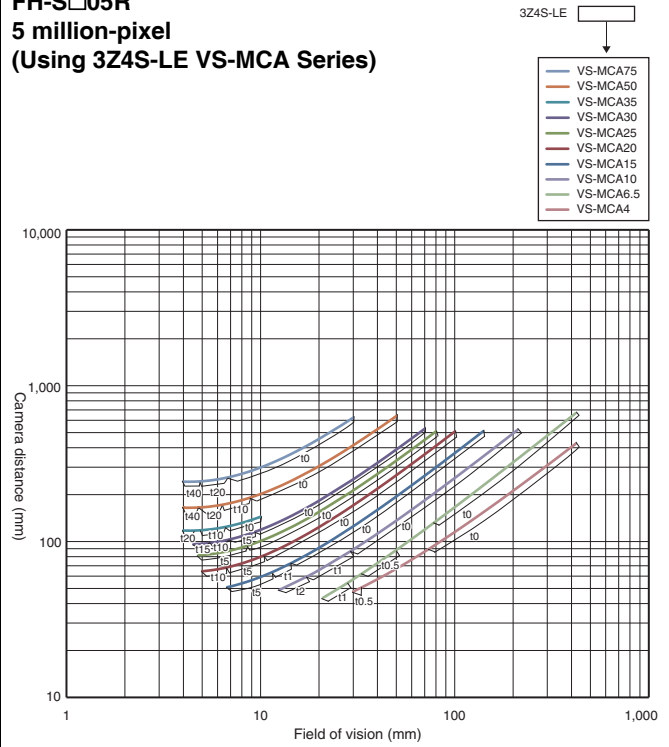

Digital CMOS Camera FZ-S□5M3, High-speed Digital CMOS Camera FH-S□X05 5 million-pixel (Using 3Z4S-LE VS-MCA Series)

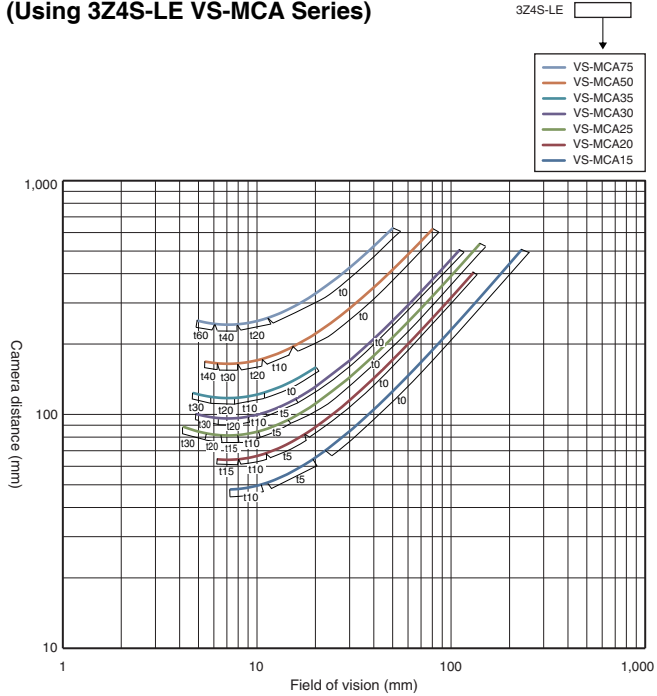

Terms and Conditions Agreement

Read and understand this catalog.

Please read and understand this catalog before purchasing the products. Please consult your OMRON representative if you have any questions or comments.

Warranties.

- (a) Exclusive Warranty. Omron's exclusive warranty is that the Products will be free from defects in materials and workmanship for a period of twelve months from the date of sale by Omron (or such other period expressed in writing by Omron). Omron disclaims all other warranties, express or implied.
- (b) Limitations. OMRON MAKES NO WARRANTY OR REPRESENTATION, EXPRESS OR IMPLIED, ABOUT NON-INFRINGEMENT, MERCHANTABILITY OR FITNESS FOR A PARTICULAR PURPOSE OF THE PRODUCTS. BUYER ACKNOWLEDGES THAT IT ALONE HAS DETERMINED THAT THE PRODUCTS WILL SUITABLY MEET THE REQUIREMENTS OF THEIR INTENDED USE.

Omron further disclaims all warranties and responsibility of any type for claims or expenses based on infringement by the Products or otherwise of any intellectual property right. (c) Buyer Remedy. Omron's sole obligation hereunder shall be, at Omron's election, to (i) replace (in the form originally shipped with Buyer responsible for labor charges for removal or replacement thereof) the non-complying Product, (ii) repair the non-complying Product, or (iii) repay or credit Buyer an amount equal to the purchase price of the non-complying Product; provided that in no event shall Omron be responsible for warranty, repair, indemnity or any other claims or expenses regarding the Products unless Omron's analysis confirms that the Products were properly handled, stored, installed and maintained and not subject to contamination, abuse, misuse or inappropriate modification. Return of any Products by Buyer must be approved in writing by Omron before shipment. Omron Companies shall not be liable for the suitability or unsuitability or the results from the use of Products in combination with any electrical or electronic components, circuits, system assemblies or any other materials or substances or environments. Any advice, recommendations or information given orally or in writing, are not to be construed as an amendment or addition to the above warranty.

See <http://www.omron.com/global/> or contact your Omron representative for published information.

Limitation on Liability; Etc.

OMRON COMPANIES SHALL NOT BE LIABLE FOR SPECIAL, INDIRECT, INCIDENTAL, OR CONSEQUENTIAL DAMAGES, LOSS OF PROFITS OR PRODUCTION OR COMMERCIAL LOSS IN ANY WAY CONNECTED WITH THE PRODUCTS, WHETHER SUCH CLAIM IS BASED IN CONTRACT, WARRANTY, NEGLIGENCE OR STRICT LIABILITY.

Further, in no event shall liability of Omron Companies exceed the individual price of the Product on which liability is asserted.

Suitability of Use.

Omron Companies shall not be responsible for conformity with any standards, codes or regulations which apply to the combination of the Product in the Buyer's application or use of the Product. At Buyer's request, Omron will provide applicable third party certification documents identifying ratings and limitations of use which apply to the Product. This information by itself is not sufficient for a complete determination of the suitability of the Product in combination with the end product, machine, system, or other application or use. Buyer shall be solely responsible for determining appropriateness of the particular Product with respect to Buyer's application, product or system. Buyer shall take application responsibility in all cases.

NEVER USE THE PRODUCT FOR AN APPLICATION INVOLVING SERIOUS RISK TO LIFE OR PROPERTY OR IN LARGE QUANTITIES WITHOUT ENSURING THAT THE SYSTEM AS A WHOLE HAS BEEN DESIGNED TO ADDRESS THE RISKS, AND THAT THE OMRON PRODUCT(S) IS PROPERLY RATED AND INSTALLED FOR THE INTENDED USE WITHIN THE OVERALL EQUIPMENT OR SYSTEM.

Programmable Products.

Omron Companies shall not be responsible for the user's programming of a programmable Product, or any consequence thereof.

Performance Data.

Data presented in Omron Company websites, catalogs and other materials is provided as a guide for the user in determining suitability and does not constitute a warranty. It may represent the result of Omron's test conditions, and the user must correlate it to actual application requirements. Actual performance is subject to the Omron's Warranty and Limitations of Liability.

Change in Specifications.

Product specifications and accessories may be changed at any time based on improvements and other reasons. It is our practice to change part numbers when published ratings or features are changed, or when significant construction changes are made. However, some specifications of the Product may be changed without any notice. When in doubt, special part numbers may be assigned to fix or establish key specifications for your application. Please consult with your Omron's representative at any time to confirm actual specifications of purchased Product.

Errors and Omissions.

Information presented by Omron Companies has been checked and is believed to be accurate; however, no responsibility is assumed for clerical, typographical or proofreading errors or omissions.

Note: Do not use this document to operate the Unit.

OMRON Corporation Industrial Automation Company
Kyoto, JAPAN

Contact: www.ia.omron.com

Regional Headquarters

OMRON EUROPE B.V.

Wegalaan 67-69, 2132 JD Hoofddorp
The Netherlands
Tel: (31)2356-81-300/Fax: (31)2356-81-388

OMRON ASIA PACIFIC PTE. LTD.

No. 438A Alexandra Road # 05-05/08 (Lobby 2),
Alexandra Technopark,
Singapore 119967
Tel: (65) 6835-3011/Fax: (65) 6835-2711

OMRON ELECTRONICS LLC

2895 Greenspoint Parkway, Suite 200 Hoffman Estates,
IL 60169 U.S.A.
Tel: (1) 847-843-7900/Fax: (1) 847-843-7787

OMRON ADEPT TECHNOLOGIES, INC.

4550 Norris Canyon Road, Suite 150, San Ramon, CA 94583 U.S.A.
Tel: (1) 925-245-3400/Fax: (1) 925-960-0590

OMRON (CHINA) CO., LTD.

Room 2211, Bank of China Tower, 200 Yin Cheng Zhong Road,
PuDong New Area, Shanghai, 200120, China
Tel: (86) 21-5037-2222/Fax: (86) 21-5037-2200

Authorized Distributor:

© OMRON Corporation 2018-2021 All Rights Reserved.
In the interest of product improvement,
specifications are subject to change without notice.

CSM_21_6
Cat. No. Q197-E1-15

0721(1118)