

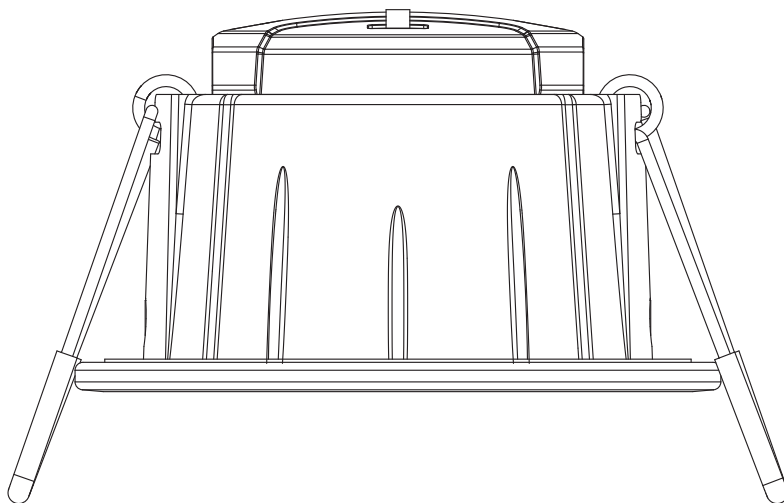

SPOT COMBO DIMMABLE

	EAN	W	lm	lm/W	K	T_{amb}^{max} (°C)	V~	mA	Hz	DF	IK	PF	∇(°)	
SP CBO FIX V 6W CPS DIM60DEG IP65WT	4099854092701	4	350	88	2700	-20...+40	220-240	19 @ 4W 27 @ 6W	50/60	0.9	03	>0.9 @ 6W	60	25000
		6	550	92										
		4	380	95	3000									
		6	580	97										
		4	400	100	4000									
		6	600	100										
SP CBO ADJ V 6W CPS DIM60DEG IP65WT	4099854092725	4	350	88	2700	-20...+40	220-240	19 @ 4W 27 @ 6W	50/60	0.9	03	>0.9 @ 6W	60	25000
		6	550	92										
		4	380	95	3000									
		6	580	97										
		4	400	100	4000									
		6	600	100										

SPOT COMBO DIMMABLE

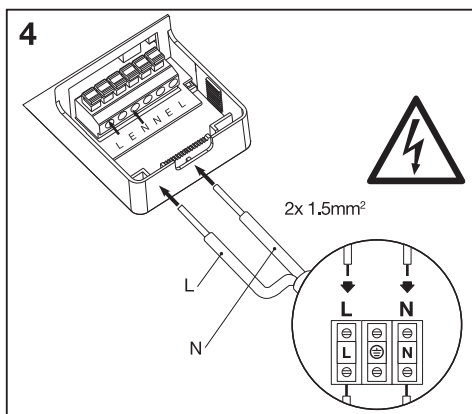
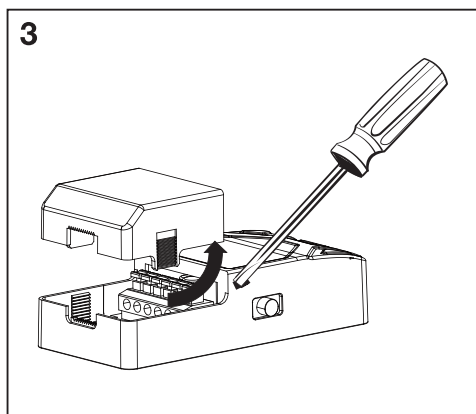
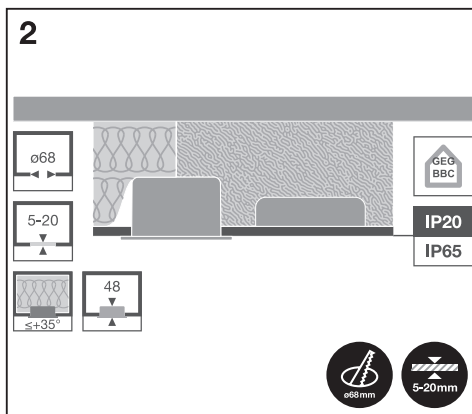
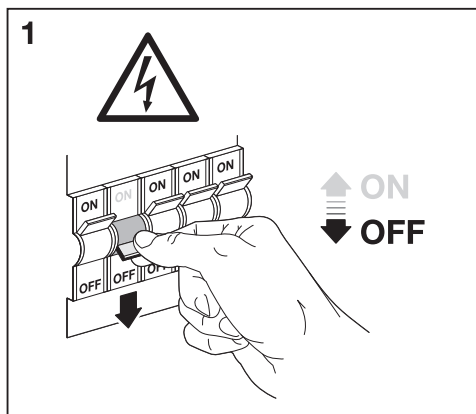
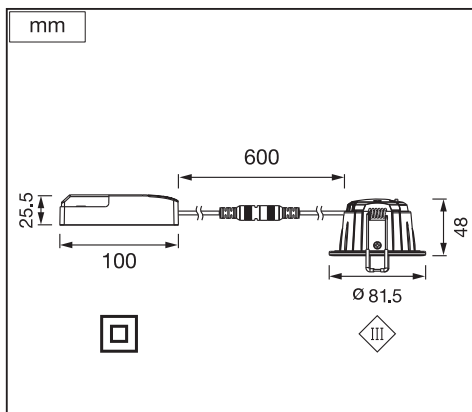
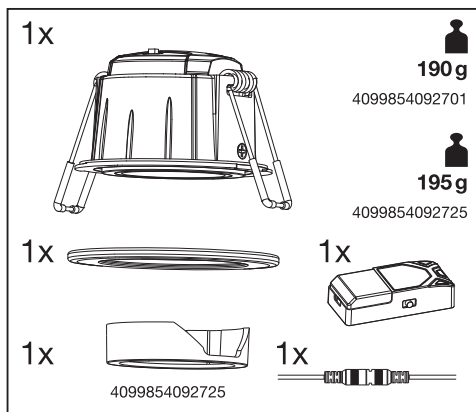

SPOT COMBO DIMMABLE



5

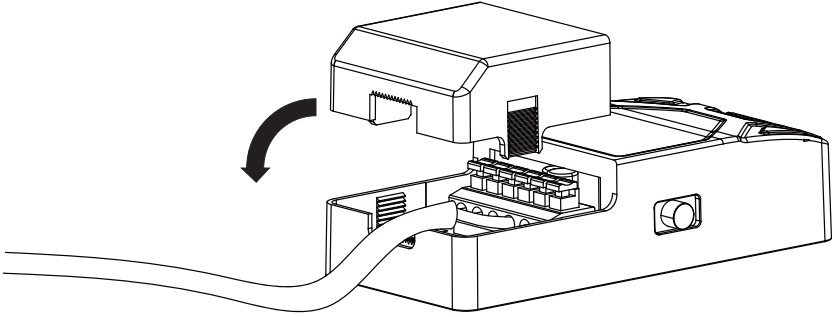

6

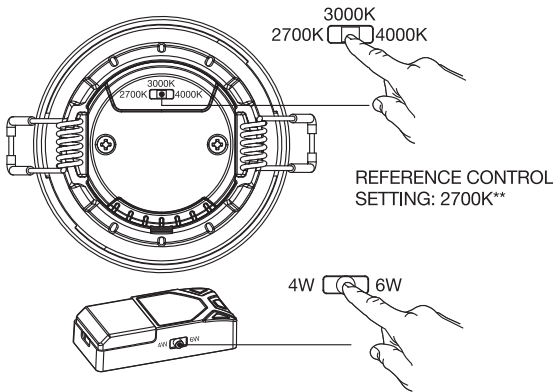

7

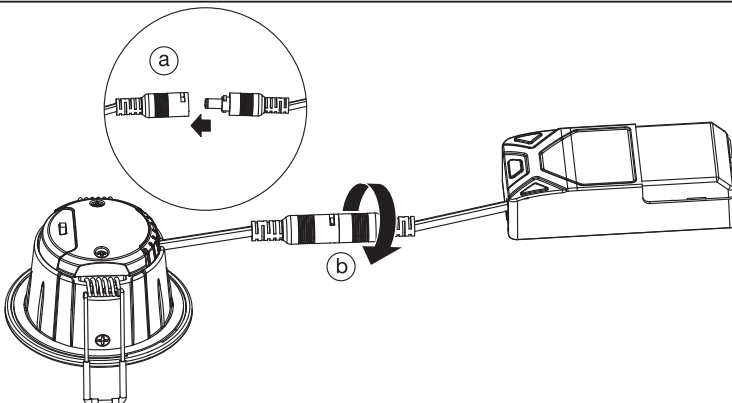

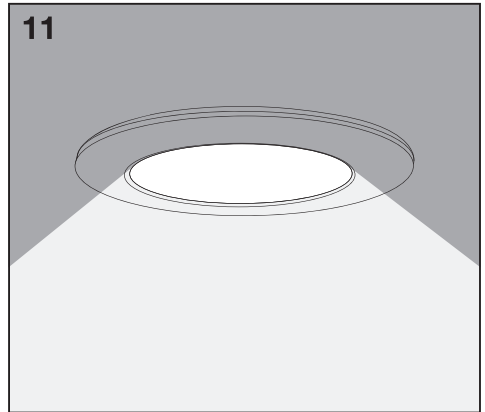
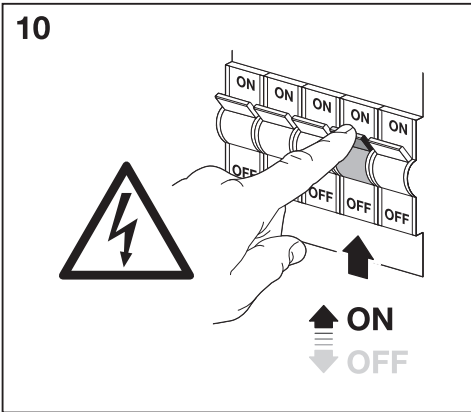
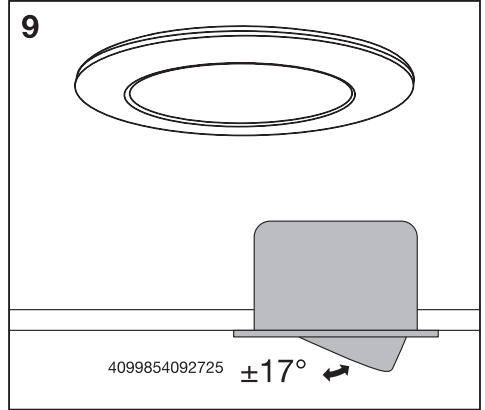
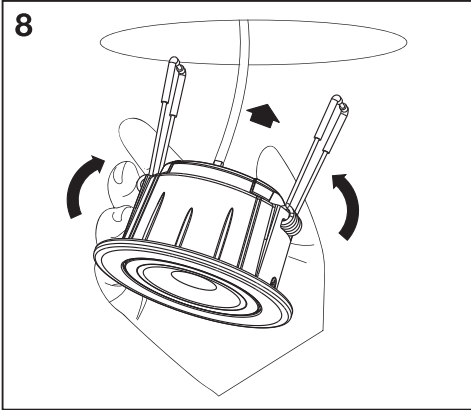
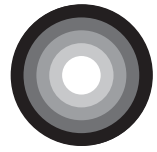

SPOT COMBO DIMMABLE

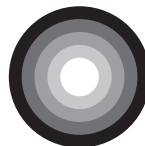

SPOT COMBO DIMMABLE



	EAN		Color		Height	Length	Diameter
SPOT COMBO DIMMABLE FIX 	4099854098406	SP COV RING FIX ROUND BK	BLACK	○	-	-	81.5
	4099854098437	SP COV RING FIX ROUND BN	BRUSHED NICKEL		-	-	81.5
	4099854099274	SP COV RING FIX SQUARE BN	BRUSHED NICKEL	□	81.5	81.5	-
	4099854099304	SP COV RING FIX SQUARE WT	WHITE		81.5	81.5	-
	4099854099335	SP COV RING FIX SQUARE BK	BLACK		81.5	81.5	-
SPOT COMBO DIMMABLE ADJUSTABLE 	4099854097911	SP COV RING ADJ ROUND BK	BLACK	○	-	-	81.5
	4099854097935	SP COV RING ADJ ROUND BN	BRUSHED NICKEL		-	-	81.5
	4099854097959	SP COV RING ADJ SQUARE BN	BRUSHED NICKEL	□	81.5	81.5	-
	4099854097973	SP COV RING ADJ SQUARE WT	WHITE		81.5	81.5	-
	4099854097997	SP COV RING ADJ SQUARE BK	BRUSHED NICKEL		81.5	81.5	-

SP CBO FIX V 6W CPS DIM60DEG IP65WT

1

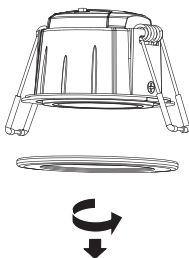

2

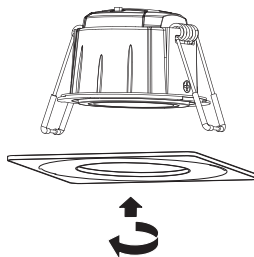





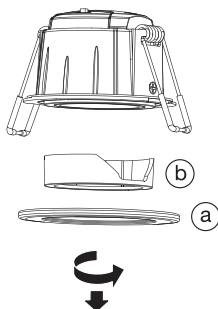

SP CBO ADJ V 6W CPS DIM60DEG IP65WT

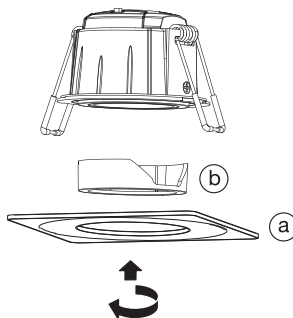

























1



























2



					 * X =
	EAN	n			
SP CBO FIX V 6W CPS DIM60DEG IP65WT	4099854092701	1	AC57824		E
SP CBO ADJ V 6W CPS DIM60DEG IP65WT	4099854092725	1	AC57825		E

*  Dieses Produkt enthält eine Lichtquelle der Energieeffizienzklasse <X>.  This product contains a light source of energy efficiency class <X>.  Ce produit contient une source lumineuse de classe d'efficacité énergétique <X>.  Questo prodotto contiene una sorgente luminosa di classe di efficienza energetica <X>.  Este producto contiene una fuente luminosa de la clase de eficiencia energética <X>.  Este produto contém uma fonte de luz da classe de eficiência energética <X>.  Το προϊόν αυτό περιέχει φωτεινή πηγή της τάξης ενεργειακής απόδοσης <X>.  Dit product bevat een lichtbron van energie-efficiëntieklasse <X>.  Denna produkt innehåller en ljuskälla med energieeffektivitetsklass <X>.  Tämä tuote sisältää valonlähteen, jonka energiatehokkuusluokka on <X>.  Dette produktet inneholder en lyskilde med energieffektivitetsklasse <X>.  Dette produkt indeholder en lyskilde i energieffektivitetsklasse <X>.  Tento výrobek obsahuje světelný zdroj s třídou energetické účinnosti <X>.  Данный продукт содержит энергосберегающий источник света (класса <X>).  Ez a termék egy <X> energiatéteghatékony forrásból áll.  Ten produkt zawiera źródło światła o klasie efektywności energetycznej <X>.  Tento výrobok obsahuje svetelný zdroj triedy energetickej účinnosti <X>.  Ta izdelek vsebuje svetlobni vir razreda enerjske učinkovitost <X>.  Bu ürün, enerji verimliliği sınıfında bir ışık kaynağıdır <X>.  Acest produs conține o sursă de lumină cu clasa de eficiență energetică <X>.  Toode sisaldab energiatõhususe klassi <X> valgusallikat.  Šiame gaminyje yra šviesos šaltinis, kurio energijos vartojimo efektyvumo klasė <X>.  Šis s ražojums satur gaismas avotu, kura energoefektivitātes klase ir <X>.  Ovaj proizvod sadrži izvor svetlosti klase energetske efikasnosti <X>.  Цей виріб містить джерело світла класу енергоефективності <X>.  Бул өнімде <X> энергия тиімділігі класының жарық көзі бар.

**  Referenzkontrolleinstellung  Réglage de la commande de référence.  Impostazione controllo di riferimento  Configuración de control de referencia  Configuração de controlo de referência.  Ρύθμιση χειρισμού αναφοράς  Referentiesteuringsinstelling  Inställning för referenskontroll  Vertiiliasetus  Referansekontrollinställning  Referenckontrolinstilling  Nastavení referenčního ovládání  Referencia vezérlés beállítás  Ustawienie kontroli wartości odniesienia  Nastavenie referenčného ovládania  Nastavitev referenčnega nadzora  Referans kontrol ayarı  Referentna kontrolna postavka  Setare control de referință  Настройка на референтния контрол  Võrdluskontrolli seadistus  Etaloninio valdymo nustatymas  Atsauces vadības iestatījums  Postavka kontrole reference  Налаштування еталонного контролю

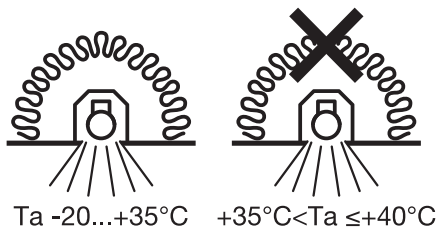

C10567405
G11180257
19.12.2023



LEDVANCE GmbH
Steinerne Furt 62
86167 Augsburg, Germany
www.ledvance.com