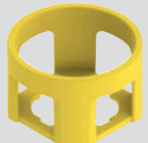

Windowed protection guard

	Article	Description
	VE GP22A5A	Cylindrical yellow protection guard with 4 windows Ø 40x20 mm

It does not alter the IP protection degree of the associated device.

Cylindrical protection guard

	Article	Description
	VE GP22B5A	Cylindrical yellow protection guard Ø 43x27 mm

Not applicable on emergency stop buttons of the E2 1PE series
It does not alter the IP protection degree of the associated device.

Open protection guard

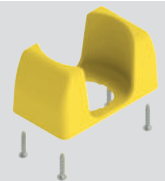
	Article	Description
	VE GP22F5A	Rectangular open yellow protection guard 66x38 mm, 35 mm high With 4 screws (for panel thicknesses between 1 and 3.5 mm).

Closing cap

Packs of **10 pcs.**





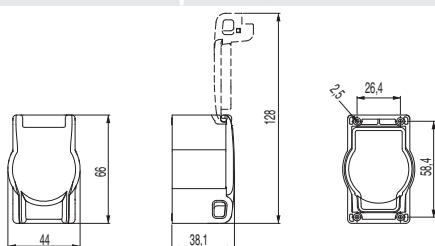

	Technical data:	
	Body and ring material:	technopolymer
	Protection degree:	IP67 and IP69K
	Tightening torque:	2 ... 2.5 Nm
	Article	Description
	E2 1TA1A110	Black closing cap for Ø 22 mm holes

Lockable guard

	Article	Description
	VE GG3EA7A	Lockable guard complete with 4 screws (for panel thicknesses between 1 and 3.5 mm)



Sockets with IP54 cover

	Article	Design	Description
	VE PE1E1AA1		Europe Schuko + Italy IEC 60884-1 with child protection 16 A 250 Vac
	VE PE1E1BA1		USA UL498/NEMA5-15 CSA22.2 no.4215 A 125 Vac
	VE PE1E1CA1		France CEE 7/V IEC 60884-1 NFC 61314 with child protection 16 A 250 Vac
	VE PE1E1DA1		United Kingdom BS1363 with child protection 13 A 250 Vac
	VE PE1E1EA1		Switzerland IEC 60884-1 SEV 1011 10 A 250 Vac
	VE PE1E1FA1		Australia / China AS/NZS 3112 15 A 250 Vac

Sockets with 4 screws for fixing

Station holder

	Article	Description
	VE SF12AD1003A	Station holder for EL AC housing with low base

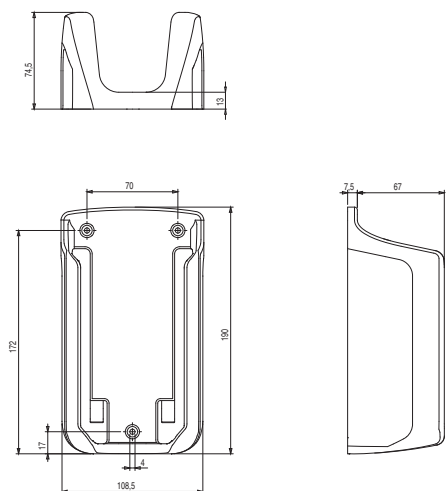

Internal socket cover

	Article	Description
	VE GG2BA5A	Yellow socket cover

Socket cover with 2 screws for fixing below socket, inside control station.

Protective cover

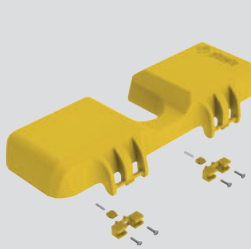
	Article	Description
	VE GG2CA5A	Yellow cover
	VE GG2CB5A	Yellow cover (IP65)
	VE GG2CA1A	Black cover (on request)

Product includes hinge and fixing screws, for EL AC control stations only.

All values in the drawings are in mm

→ The 2D and 3D files are available at www.pizzato.com

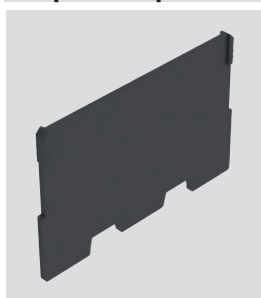
Separator plate

Article	Description
VE GG2DA1A	Separator plate

Separator plate (which can be installed in various positions) to separate control station parts with different voltages. For EL AN●●●● control stations only.

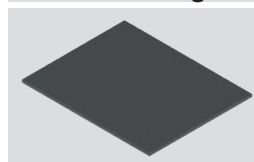
Adhesive magnetic bases

Adhesive magnetic base made of magnetic plasto-ferrite for application on the bottom of EL AC●●●●, EL AN●●●●, and EL AD control stations. Allows control stations to be attached to metallic surfaces.

Article	Description
VE BM2B56X70	56x70 mm for EL AN21●●● housing
VE BM2B87X70	87x70 mm for EL AN22●●● housing
VE BM2B120X70	120x70 mm for EL AN23●●● housing
VE BM2B153X70	153x70 mm for EL AN24●●● housing
VE BM2B230X70	230 x 70 mm for EL AC27●●● and EL AD●●●● housing

Emergency stop buttons

Body colour and marking	Actuator colour	Push-pull	Rotary release	Windowed push-pull	Windowed rotary release	Key release Key coding PY333
yellow	red	E2 1PEPZ4531	E2 1PERZ4531	E2 1PEPF4531	E2 1PERF4531	E2 1PEBZ4531
yellow with green indication	red	E2 1PEPZ4731	E2 1PERZ4731	E2 1PEPF4731	E2 1PERF4731	E2 1PEBZ4731
yellow	black	E2 1PEPZ4511	E2 1PERZ4511	/	/	E2 1PEBZ4511

Selector switches

Actuator colour and engraving	Positions	2 stable positions		Actuator colour and engraving	Positions	3 stable positions	
		Black bezel				Black bezel	
black	V	E2 1SE12AVA11AB		black	↓	E2 1SE13ACE11AB	

Key selector switches

Colour and engraving actuator	Positions	2 stable positions		Legend
		Black bezel		
black	V	E2 1SC2AVA11AA		V Maintained
	↓			↓ Spring-return
	⌘			⌘ Key extraction position

Luminous discs with steady light

Colour and engraving	Article	Description
White	VE DL1A2A00	White luminous disc, Ø 60 mm, 24 Vac/dc, without engraving, 5 LUX at 1m.
Yellow	VE DL1A5A00	Yellow luminous disc, Ø 60 mm, 24 Vac/dc, without engraving
Yellow with engraving	VE DL1A5A13	Yellow luminous disc, Ø 60 mm, 24 Vac/dc, with engraving: V V V V

Luminous discs with blinking light

Colour and engraving	Article	Description
White	VE DL1A2L00	White luminous disc, blinking (0.5s on, 0.5s off), Ø 60 mm, 24 Vac/dc, without engraving, 5 LUX at 1 m.
Yellow	VE DL1A5L00	Yellow luminous disc, flashing (0.5s on, 0.5s off), Ø 60 mm, 24 Vac/dc, without engraving
Yellow with engraving	VE DL1A5L13	Yellow luminous disc, flashing (0.5s on, 0.5s off), Ø 60 mm, 24 Vac/dc, with engraving: V V V V

→ The 2D and 3D files are available at www.pizzato.com

Double buttons



Colour and engraving actuator		Upper button flush Central cap, flush Lower button flush	
		Function	Black bezel
	"→" black button	DOWN	E2 1PDRL1AABS
	white cap, illuminated		
	"←" white button	UP	
	"↑" white button	UP	E2 1PDRL1AABN
	white cap, illuminated		
	"↓" black button	DOWN	
	△ yellow button white cap, illuminated	ALARM	E2 1PDRL1AADJ
	↕ blue button	ENABLE	
	● black button	LIGHT	E2 1PDRL1AABR
	white cap, illuminated		
	△ yellow button	ALARM	
	● black button	LIGHT	E2 1PDRL1AADL
	white cap, illuminated		
	↕ blue button	ENABLE	

Triple buttons



Actuator colour and engraving		Upper button flush Central button projecting Lower button flush	
		Function	Black bezel
	● black button	LIGHT	E2 1PTRS1AADK
	△ yellow button	ALARM	
	↕ blue button	ENABLE	
	"→" black button	DOWN	E2 1PTRS1AABK
	white cap, illuminated		
	△ yellow button	ALARM	
	"←" white button	UP	

Single buttons and mushroom buttons



Actuator colour and engraving	Function	Single button flush	Mushroom button Ø 36 mm flush
		Black bezel	Black bezel
	UP	E2 1PU2R221L7	/
	DOWN	E2 1PU2R121L8	/
	LIGHT	E2 1PU2R121L16	E2 1PU2F141L16
	LIGHT	E2 1PU2R521L16	E2 1PU2F541L16
	ALARM	E2 1PU2R521L14	E2 1PU2F541L14
	ENABLE	E2 1PU2R621L170	/

Quadruple buttons



Actuator colour and engraving (starting from the top and clockwise)		upper button flush right button flush lower button flush left button flush	
		Function	black bezel
	↑ white button	UP	E2 1PQFA1QAAQ
	● black button	LIGHT	
	↓ black button	DOWN	
	△ yellow button	ALARM	
	↑ white button	UP	E2 1PQFA1QAAS
	● black button	LIGHT	
	↓ black button	DOWN	
	↕ blue button	ENABLE	
	↑ white button	UP	E2 1PQFA1QAAR
	△ yellow button	ALARM	
	↓ black button	DOWN	
	↕ blue button	ENABLE	

→ The 2D and 3D files are available at www.pizzato.com

High luminosity monolithic indicator lights

 Packs of **10 pcs.**

Colour	Operating voltage		
	12 ... 30 Vac/dc	120 Vac	230 Vac
white	E6 1IL1A2110	E6 1IL3A2110	E6 1IL4A2110
red	E6 1IL1A3110	E6 1IL3A3110	E6 1IL4A3110
green	E6 1IL1A4110	E6 1IL3A4110	E6 1IL4A4110
yellow	E6 1IL1A5110	E6 1IL3A5110	E6 1IL4A5110
blue	E6 1IL1A6110	E6 1IL3A6110	E6 1IL4A6110
orange	E6 1IL1A8110	E6 1IL3A8110	E6 1IL4A8110

Buzzers



Sound type	Operating voltage	Perforated lens	Perforation-free lens
Continuous ←	12 Vac/dc	E6 1IS5A1CV1B	E6 1IS5B1CV1B
	24 Vac/dc	E6 1IS6A1CV1B	E6 1IS6B1CV1B
Pulsing ← -	12 Vac/dc	E6 1IS5A1PV1B	E6 1IS5B1PV1B
	24 Vac/dc	E6 1IS6A1PV1B	E6 1IS6B1PV1B

Minimum level of sound intensity:
 24 Vac/dc versions: 95 dB at 10cm (perforated lens)
 80 dB at 10cm (perforation-free lens)
 12 Vac/dc versions: 90 dB at 10cm (perforated lens)
 75 dB at 10cm (perforation-free lens)

USB sockets



For ordering a **USB 3.0 socket** replace C with A in the respective article code.
 Example:
 E2 1USB9CAK → E2 1USB1AAK

Rear connection	Front connection A-type USB 2.0 integrated socket black bezel	
A-type USB integrated socket	E2 1USB1CAK	/
Output with PVC cable, length 1.8 m and A-type USB male connector	/	E2 1USB1CN1.8
Output with PVC cable, length 3 m and A-type USB male connector	/	E2 1USB1CN3
Output with PVC cable, length 5 m and A-type USB male connector (available only with USB 2.0 socket)	/	E2 1USB1CN5

RJ45 sockets



For ordering a **socket with black bezel** replace 9 with 1 in the respective article code. Example:
 E2 1RJ459AAK → E2 1RJ451AAK

Connection type	Transfer speeds	
	1 Gb/s (for Cat. 5e)	10 Gb/s (for Cat. 6)
Integrated RJ45 socket	E2 1RJ459AAK	E2 1RJ459CAK
Output with PVC cable (length 1 m) and RJ45 male connector	E2 1RJ459AN1	E2 1RJ459CN1
Output with PVC cable (length 1.5 m) and RJ45 male connector	E2 1RJ459AN1.5	E2 1RJ459CN1.5
Output with PVC cable (length 2.5 m) and RJ45 male connector	E2 1RJ459AN2.5	E2 1RJ459CN2.5

Adapter for DIN rail

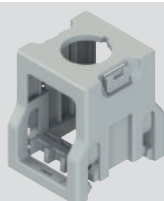
 Packs of **10 pcs.**

Patent pending

Article	Description
VE AD3PF9A0	Support with Ø22 hole for fixing on DIN rail of the signalling and control devices of the EROUND line

Not suitable for joysticks and quadruple buttons

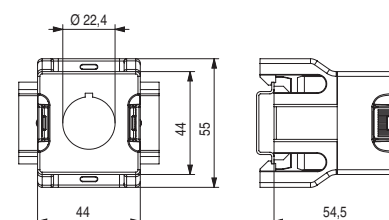

All values in the drawings are in mm

 → The 2D and 3D files are available at www.pizzato.com

Single contact blocks

Packs of 10 pcs.

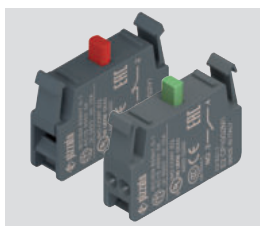

Article		Contacts
Clamping screw connection	PUSH-IN spring-operated connection	
E2 CP01G2V1	E2 CP01G2M1	Slow action 1NC \ominus
E2 CP10G2V1	E2 CP10G2M1	Slow action 1NO
E2 CP01K2V1	E2 CP01K2M1	Slow action 1NC \ominus delayed
E2 CP10L2V1	E2 CP10L2M1	Slow action 1NO early make

General data

Protection degree:	IP20 acc. to IEC 60529
Ambient temperature:	-40°C ... +80°C
Mechanical endurance:	20 million operating cycles
Max. actuation frequency:	3600 operating cycles/hour
Material of the contacts:	Silver contacts
Contact type:	"V-shape" self-cleaning contacts with quadruple contact point

Electrical data

Thermal current (I_{th}):	10 A
Rated insulation voltage (U_i):	500 Vac/dc
Protection against short circuits:	type gG/gL fuse 10 A 500 V
Rated impulse withstand voltage (U_{imp}):	8 kV
Pollution degree:	3

Clamping screw connection

Cable cross section:	min 1 x 0.5 mm ² (1 x AWG 20) max 2 x 2.5 mm ² (2 x AWG 14)
Tightening torque:	0.6 ... 0.8 Nm
Cable stripping length (x):	8 mm

Utilization category

Alternating current: AC15 (50÷60 Hz)					
U_e (V)	24	48	120	250	400
I_e (A)	6	6	6	6	3
Direct current: DC13					
U_e (V)	24	48	125	250	
I_e (A)	2.5	1.3	0.6	0.3	

PUSH-IN spring-operated connection

Cable cross section (flexible conductors, with or without wire-end sleeve):	min. 1 x 0.25 mm ² (1 x AWG 24) max. 2 x 1.5 mm ² (2 x AWG 16)
Cable stripping length (x):	min. 8 mm, max. 10 mm



Double contact blocks

Packs of 5 pcs.

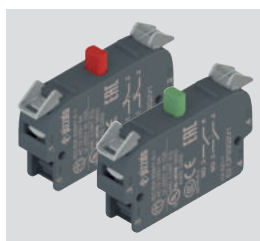

Article	Contacts
E2 CP11G2V1	Slow action 1NO+1NC \ominus
E2 CP20G2V1	Slow action 2NO
E2 CP02G2V1	Slow action 2NC \ominus

General data

Protection degree:	IP20 acc. to IEC 60529
Ambient temperature:	-40°C ... +80°C
Mechanical endurance:	20 million operating cycles
Max. actuation frequency:	3600 operating cycles/hour
Material of the contacts:	Silver contacts
Contact type:	"V-shape" self-cleaning contacts with quadruple contact point
Cable cross section:	min 1 x 0.34 mm ² (1 x AWG 22) max. 2 x 1.5 mm ² (2 x AWG 16)
Screw tightening torque:	0.6 ... 0.8 Nm
Cable stripping length (x):	7 mm

Electrical data

Thermal current (I_{th}):	10 A
Rated insulation voltage (U_i):	250 Vac/dc
Protection against short circuits:	type gG/gL fuse 10 A 500 V
Rated impulse withstand voltage (U_{imp}):	4 kV
Pollution degree:	3

Utilization category

Alternating current: AC15 (50÷60 Hz)					
U_e (V)	24	48	120	250	
I_e (A)	6	6	6	6	
Direct current: DC13					
U_e (V)	24	48	125	250	
I_e (A)	2.5	1.3	0.6	0.3	

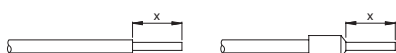
→ The 2D and 3D files are available at www.pizzato.com



High luminosity LED unit

Packs of 5 pcs.

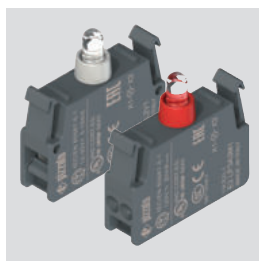

LED colour	Available device colour	Clamping screw connection			PUSH-IN spring-operated connection		
		Operating voltage					
		12 ... 30 Vac/dc	120 Vac	230 Vac	12 ... 30 Vac/dc	120 Vac	230 Vac
white	white / yellow	E2 LP1A2V1	E2 LP3A2V1	E2 LP4A2V1	E2 LP1A2M1	E2 LP3A2M1	E2 LP4A2M1
red	red	E2 LP1A3V1	E2 LP3A3V1	E2 LP4A3V1	E2 LP1A3M1	E2 LP3A3M1	E2 LP4A3M1
green	green	E2 LP1A4V1	E2 LP3A4V1	E2 LP4A4V1	E2 LP1A4M1	E2 LP3A4M1	E2 LP4A4M1
blue	blue	E2 LP1A6V1	E2 LP3A6V1	E2 LP4A6V1	E2 LP1A6M1	E2 LP3A6M1	E2 LP4A6M1
orange	orange	E2 LP1A8V1	E2 LP3A8V1	E2 LP4A8V1	E2 LP1A8M1	E2 LP3A8M1	E2 LP4A8M1

General data

Protection degree: IP20 acc. to IEC 60529
 Ambient temperature: -25°C ... +70°C
 Endurance: 100,000 hours (at rated voltage and +25 °C ambient temperature)

Electrical data

Operating voltages and currents: 12 ... 30 Vac/dc; 5 ... 20 mA
 102 ... 138 Vac; 20 mA max.
 195 ... 264 Vac; 20 mA max.
 Blinking frequency: 1 Hz

Clamping screw connection

Cable cross section: min 1 x 0.5 mm² (1 x AWG 20)
 max 2 x 2.5 mm² (2 x AWG 14)
 Tightening torque: 0.6 ... 0.8 Nm
 Cable stripping length (x): 8 mm

PUSH-IN spring-operated connection

Cable cross section (flexible conductors, with or without wire-end sleeve):
 min. 1 x 0.25 mm² (1 x AWG 24)
 max. 2 x 1.5 mm² (1 x AWG 16)
 Cable stripping length (x): min. 8 mm, max. 10 mm

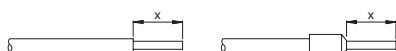

Single self-monitored contact blocks

Packs of 5 pcs.

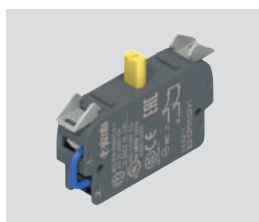

Article	Contacts
E2 CP01S2V1	Slow action, self-monitored 1NC

The operating principle of the self-monitoring contact blocks ensures that their associated control devices are free from faults and malfunctions caused by contacts separating, and that the safety function remains permanently available during machine operation.

General data

Protection degree: IP20 acc. to IEC 60529
 Ambient temperature: -40°C ... +80°C
 Mechanical endurance: 20 million operating cycles
 Max. actuation frequency: 3600 operating cycles/hour
 Material of the contacts: Silver contacts
 Contact type: "V-shape" self-cleaning contacts with quadruple contact point
 Cable cross section: min 1 x 0.34 mm² (1 x AWG 22)
 max. 2 x 1.5 mm² (2 x AWG 16)
 Screw tightening torque: 0.6 ... 0.8 Nm
 Cable stripping length (x): 7 mm

Electrical data

Thermal current (I_{th}): 10 A
 Rated insulation voltage (U_i): 250 Vac/dc
 Protection against short circuits: type gG/gL fuse 10 A 500 V
 Rated impulse withstand voltage (U_{imp}): 4 kV
 Pollution degree: 3

Utilization category

Alternating current: AC15 (50÷60 Hz)

U_e (V)	24	48	120	250
I_e (A)	6	6	6	6

 Direct current: DC13

U_e (V)	24	48	125	250
I_e (A)	2.5	1.3	0.6	0.3



→ The 2D and 3D files are available at www.pizzato.com

Mounting adapter

Packs of **10 pcs.**

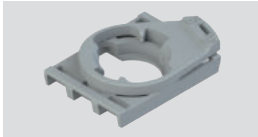

Article	Description
E2 1BAC11	3-slot mounting adapter for E2 CP contact blocks and E2 LP LED units

Not combinable with E2 •PQ••••• quadruple buttons and E2 •MA••••• joysticks.

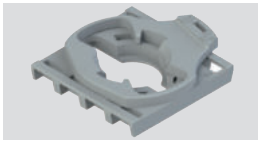

Article	Description
E2 1BAC21	4-slot mounting adapter for E2 CP contact blocks

Compatible only with selectors E2 •SE•••••, key selector switches E2 •SC•••••, buttons E2 •PU•••••, double buttons E2 •PD•••••, emergency stop buttons E2 •PE•••••, configured in the appropriate versions for 4-slot adapter. Compatible with E2 •PQ••••• quadruple buttons and E2 •MA••••• joystick

Fixing ring

Packs of **20 pcs.**



Article	Description
VE GF121A	Technopolymer fixing ring



Article	Description
VE GF720A	Metal fixing ring

Fixing key



Article	Description
VE CH121A1	Technopolymer fixing key for VE GF••••• fixing rings

Changeover switches for EL control stations



Article	Positions	Contacts								L (mm)
		1-2	3-4	5-6	7-8	9-10	11-12	13-14	15-16	
EH B2A11B-P01	∨	NC	NO	-	-	-	-	-	-	32
EH B2A22B-P01	∨	NC	NO	NC	NO	-	-	-	-	41.5
EH B2A24B-P01	∨	NO	NO	NC	NC	NC	NC	-	-	51
EH B2A33B-P01	∨	NC	NO	NC	NO	NC	NO	-	-	51
EH B2A35B-P01	∨	NO	NC	NO	NC	NO	NC	NC	NC	60.5

ATTENTION: only available pre-assembled on control stations

General data

Protection degree acc. to IEC 60529: IP67 only if installed on appropriate EL series cover.
IP20 at the terminals

Ambient temperature: -20°C ... +50°C

Mechanical endurance: 500,000 operating cycles at 120 operating cycles/hour

Material of the contacts: Silver contacts

Tightening torque of the terminal screws: 1.2 Nm

Thermal current (I_m): 16 A

Rated insulation voltage (U_i): 660 Vac

Rated impulse withstand voltage (U_{imp}): 4 kV

Cross-section of stranded wire: min. 1 x 0.5 mm²
max. 2 x 2.5 mm²

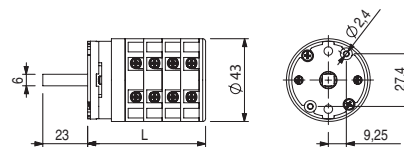

Vac	Rated operating current I_e : alternating current (50/60 Hz)				
	AC-21A	AC23A		AC-3	
		1PH	3PH	1PH	3PH
110-120	16 A	0.5 kW	/	0.4 kW	/
220-240	16 A	0.9 kW	2.6 kW	0.75 kW	2.2 kW
380-400	16 A	1.5 kW	7.5 kW	1.3 kW	5.5 kW

Bypass switches



Article	Description
EH AC-005	4-position switch for bypass with padlockable guard, for panel fixing

External dimensions and mounting holes:

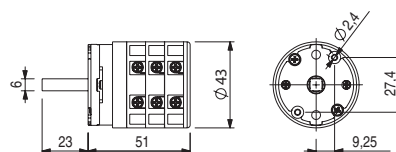

For external dimensions and device mounting holes for padlockable guard, see page 125.

General data

Ambient temperature:	-20°C ... +50°C
Mechanical endurance:	500,000 operating cycles at 120 operating cycles/hour
Material of the contacts:	Silver contacts
Tightening torque of the terminal screws:	1.2 Nm
Thermal current (I_{th}):	16 A
Rated insulation voltage (U_i):	660 Vac
Rated impulse withstand voltage (U_{imp}):	4 kV
Cross-section of stranded wire:	min. 1 x 0.5 mm ² max. 2 x 2.5 mm ²

Position	Contact diagram					
	1-2	3-4	5-6	7-8	9-10	11-12
0	X					X
1		X			X	
2			X		X	
3				X	X	

X = closed contact

Other contact configurations available on request.

Rated operating current I_e : alternating current (50/60 Hz)					
Vac	AC-21A	AC23A		AC-3	
		1PH	3PH	1PH	3PH
110-120	16 A	0.5 kW	/	0.4 kW	/
220-240	16 A	0.9 kW	2.6 kW	0.75 kW	2.2 kW
380-400	16 A	1.5 kW	7.5 kW	1.3 kW	5.5 kW

General requirements

All electrical components and devices of the EROUND series that are to be installed inside switching cabinets or enclosures (e.g. E2 CP, E2 CF, E2 LP, E2 LF), are not provided with suitable protections against: water, high quantities of dust, condensation, humidity, steam, corrosive agents, explosive gases, flammable gases or other polluting agents. The protection degree of switching cabinets or enclosures shall ensure the necessary protection to the electrical components of the EROUND series inside them, depending on the application area.

Reference dowel

The mounting reference dowel on the external diameter of all EROUND line devices enables perfect device alignment and mounting on the panel, while avoiding rotations.

In case of use on holes without reference notches, simply remove the dowel with a slight leverage effect using a screwdriver, making sure that the seal gasket does not get damaged.

The removal of the reference dowel, is not advisable for the selectors (series E2 •SE, E2 •SL, E2 •SC) and emergency stop buttons (series E2 •PE) with rotary release, as these devices are subject to rotary-type actuation.

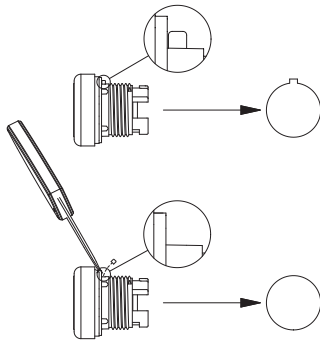

Seal gasket

Thanks to its design, the seal gasket ensures a pre-fixing on the panel. This allows to mount the ring without having to hold the device in position.

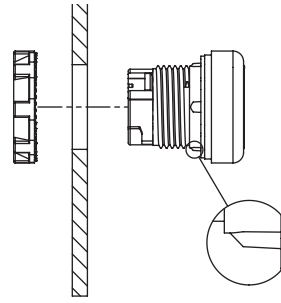

Mounting of contact blocks and LED units

Contact blocks and LED units are provided with two snap-in mounting flaps that ensure a stable fixing between them and the mounting adapter (in the panel mounting version), or between them and the base of the housing (in the base mounting version). The panel contact blocks can be connected to each other, up to three, in observance of the limits specified for each actuator in the respective chapter. Contact blocks and LED units can be quickly disassembled by using a flat-head screwdriver to leverage on the connection flaps.

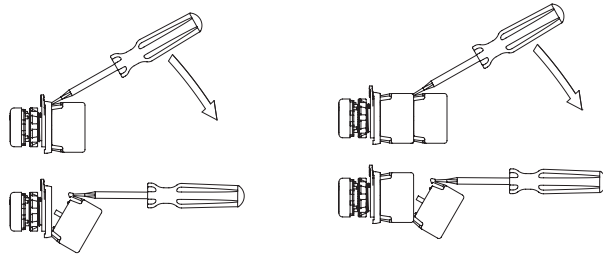

Release of the contact block from the base

Release of the contact block from another unit

Connection to mounting adapter

After its installation on the panel using the special ring, the control device can be fixed to the mounting adapter by turning the locking lever. The lever reports the free position (lock open) and locked position (lock closed) indications.

The locking lever rotation can be made smoother by using a flat-head screwdriver.

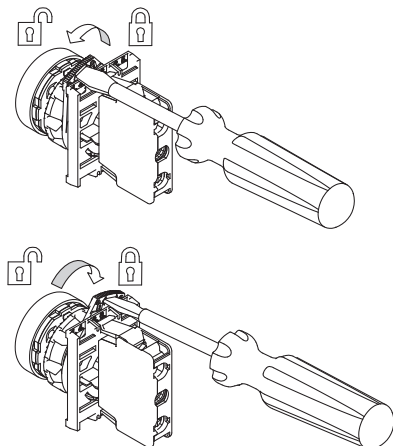

Panel fixing

The control and signalling devices have to be fixed on the rear of the panel with a fixing ring. This has to be tightened with the special fixing key which is supplied as an accessory.

The tightening torque for a correct fixing must be between 2.0 and 2.5 Nm.

Once the fixing ring has been tightened, the mounting adapter and then the contact blocks or LED units can be mounted on the panel.

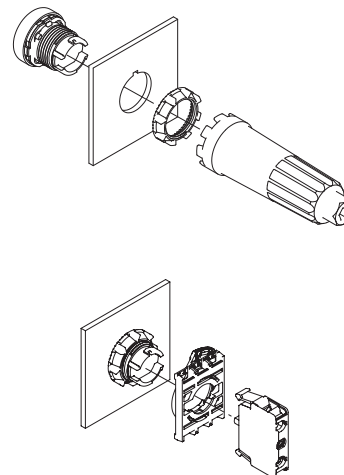

Lenses for E2 indicator lights

The E2 indicator lights are provided with interchangeable lenses in different colours. The lenses can be removed and mounted by simply turning them clockwise and anticlockwise respectively, without using tools.

For a correct colour rendering, it is necessary to use the correct combination between colour of the indicator light lens and colour of the LED unit applied to it.

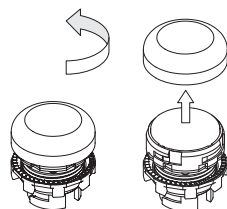

Lenses for buttons and illuminated buttons

The buttons and the illuminated buttons feature replaceable lenses. To remove the lenses, leverage them with a pointed object near the reference notch on the external diameter of the lens itself.

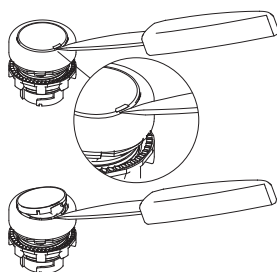

Using the devices

- All devices of the EROUND series are hand operated.
- Do not apply excessive force to the device once it has reached the end of its actuation travel.
- Do not exceed the maximum actuation travel.
- Before installation, make sure the device is not damaged in any part.
- Do not disassemble or try to repair the device, in case of defect or fault replace the entire device.
- In case the device is deformed or damaged it must be entirely replaced. Correct operation cannot be guaranteed if the device is deformed or damaged.
- Always attach the device operating instructions (if present) to the manual of the machine in which the device is installed.
- These operating instructions must be kept available for consultation at any time and for the whole period of use of the device.

Shock and vibrations

Avoid collisions with the devices. Excessive shock and vibrations may affect correct operation of the device

Wiring and installation

- Installation must be carried out by qualified staff only.
- Observe minimum distances between devices.
- Observe the tightening torques.
- Keep the electrical load below the value specified by the utilization category.
- Disconnect the power before to work on the contacts, also during the wiring.
- Do not paint or varnish the devices.
- Devices can only be installed on perforated surfaces with a thickness of between 1 mm and 6 mm that comply with the IEC 60947-5-1 standard.
- The protection degree and the correct operation are only guaranteed if the product is installed on a level and smooth surface and if the diameter of the holes is compliant with the IEC 60947-5-1 standard.
- After and during the installation do not pull the electrical cables connected to the contact blocks. If excessive tension is applied to the electrical cables, the contact blocks could detach from the actuator.
- During the coupling and uncoupling of the contact blocks from the mounting adapter or from the base, do not deform or put excessive stress on the coupling flaps. A possible deformation of the flaps could cause the detachment of the contact blocks from their mounting adapter.
- The housings in the EL AC, EL AN, EL AD series are fitted with knock-out holes for the passage of electrical cables. Open these holes using a suitable tool to avoid damaging the housing. Refrain from using housings damaged or cracked as a result of erroneous manoeuvres performed when opening the knock-out holes. After opening the hole, remove any plastic residues and insert a cable gland (or similar device) into the hole with a degree of protection equal or superior to that of the housing.
- After installation and before commissioning of the machine, verify:
 - the correct operation of the device;
 - the correct and full locking of the E2 1BAC•• mounting adapter to the device;
 - the correct coupling of the contact blocks.
- Periodically check for correct device operation.
- Do not deform or modify the device for any reason.
- Before installation, make sure the device is not damaged in any part.
- Refrain from opening, disassembling or attempting to repair the device and replace it immediately if it appears to be damaged.
- Should the installer be unable to fully understand the utilization requirements, the product must not be installed and the necessary assistance may be requested.

Do not use in following environments:

- Environments where dust and dirt can cover the device and by sedimentation stop its correct working.
- Environment where sudden temperature changes cause condensation.
- Environments where coatings of ice may form on the device.
- Environments where the application causes knocks or vibrations that could damage the device.
- Environment with presence of explosive or flammable gas or dust.
- In environments containing strongly aggressive chemicals, where the products used coming into contact with the device may impair its physical or functional integrity.

Limits of use

- Use the devices following the instructions, complying with their operation limits and the standards in force.
- The devices have specific application limits (min. and max. ambient temperature, mechanical endurance, protection degree, utilisation category, etc.) These limits are met by the different devices only if considered individually and not if combined with each other. For further information contact our technical department.
- The utilization implies knowledge of and compliance with following standards: EN 60204-1, EN 60947-5-1, ISO 12100, EN ISO 14119.
- Please contact our technical department for information and assistance (phone +39.0424.470.930 / e-mail tech@pizzato.com) in the following cases:
 - Cases not mentioned in the present utilization requirements.
 - In nuclear power stations, trains, airplanes, cars, incinerators, medical devices or any application where the safety of two or more persons depend on the correct operation of the device.

vide the operator with efficient protection.

- The safety category of the system comprising the safety device also depends on external devices and their connection. Check that the device is capable of performing the safety function envisaged by the risk analysis of the machine, as provided by EN ISO 13849-1.

Additional requirements for safety applications

Provided that all previous requirements for the devices are fulfilled, for installations with operator protection function additional requirements must be observed.

- The utilization implies knowledge of and compliance with following standards: IEC 60204-1, IEC 60947-5-1, EN ISO 13849-1, EN 62061, EN ISO 12100.
- For emergency stop buttons the safety circuit must be connected to the .1-.2 NC contacts with the actuator in rest position. The auxiliary contacts NO .3-.4 must be used in signalling circuits only.
- The protection fuse (or equivalent device) must be always connected in series with the NC .1-.2 contacts of the safety circuit.
- Periodically verify the correct working of the safety devices; the periodicity of this verification is settled by the machine manufacturer based on the machine danger degree and it does not have to be less than one a year.
- After installation and before commissioning of the machine, verify:
 - the correct operation of the device;
 - the correct and full locking of the E2 1BAC•• mounting adapter;
 - the correct coupling of the contact blocks.
- For the E2 •PEBZ•••• emergency stop buttons with key release do not leave the key inserted. A possible sudden activation of the emergency stop button with the key inserted could cause injuries to the operator.
- All the safety devices installed on the machine (e.g. emergency stop button, stop button, automatic/manual mode selector etc.) have a limited endurance. Although still functioning, after 20 years from the date of manufacture the device must be replaced completely. The date of manufacture is placed next to the product code, on the label attached to the packing. In case of particularly adverse weather conditions, the endurance of the device can be drastically reduced over time. Regularly check that the safety devices are working properly and if required, replace them, even prior to the above-mentioned expiry date.
- The device is provided with external marking on its packaging. The marking includes: Producer trademark, product code, batch number and date of manufacture. The batch's first letter refers to the month of manufacture (A=January, B=February, etc.). The second and third letters refer to the year of manufacture (24 = 2024, 25 = 2025, etc.).
- If the device is used for safety applications, inadequate installation or tampering can cause people serious injuries and even death.
- These devices must not be bypassed, removed, turned or disabled in any other way.
- If the machine where the device is installed is used for a purpose other than that specified by the producer, the device may not pro-

