

INSTRUCTION

Centryxx IP
672282.002

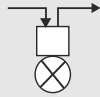

~ 220 - 240 V 50/60 Hz IP 65 IK08

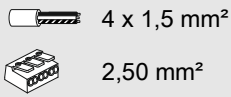

Dauerschaltung / maintained
=> 5 °C ... + 30 °C
Bereitschaftsschaltung / non
maintained
=> 5 °C ... + 30 °C

8 h
NiMH
4,8 V - 4 Ah

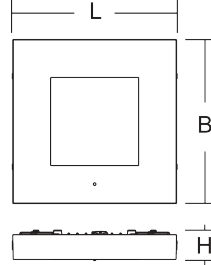

L 198, B 198, H 38

1,03 kg

	Φ [lm]	P [W]	Φ [lm]	P		
LED	420	6,5	120	1 x 4 W		
CCT [K]	CRI	RG	[m]	EEK		
6500	70	RG 2	0,5	E		
I_{max} / I_{T50}	B10 [St.]	B16 [St.]	C10 [St.]	C16 [St.]	COS φ	
0,12 A / 5000 μ s	30	40	30	40	0,57	

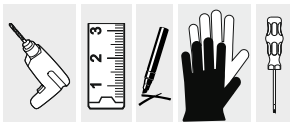



Allgemeine Sicherheitshinweise

- Der elektrische Anschluss muss ordnungsgemäß nach geltenden Normen und den nationalen sowie internationalen Sicherheits- und Unfallverhütungsvorschriften erfolgen.
- Beschädigte Leuchten dürfen nicht betrieben werden.
- Keine Haftung für Schäden durch unsachgemäßen Einsatz.
- Bei Instandsetzung nur Originalteile verwenden.
- Tragfähigkeit der Decke und Befestigungselemente sicherstellen.

Betrieb der Leuchte

- Die unzulässigen Umgebungstemperaturen reduzieren die Lebensdauer der Leuchte, im Extremfall droht der Frühausfall.
- Zur Vermeidung von EMV-Problemen die Durchgangsverdrahtung nicht entlang der Leuchtenverdrahtung führen.
- Steuereingänge von dimmbaren Leuchten mit handelsüblichen für Netzspannung geeigneten Leitungen anschließen.

Manipulationen unserer Produkte sind unzulässig

Veränderung, Umarbeitung, Umkennzeichnung von Produkten sowie deren Verpackung sind unzulässig und verletzen u.a. unsere eingetragenen Warenzeichenrechte. Solche Modifikationen können technische Eigenschaften unserer Produkte negativ beeinflussen, diese zerstören und möglicherweise Folgeschäden an anderen Objekten verursachen. Für durch derartige Modifikationen verursachte Schäden kann der Hersteller in keinem Fall verantwortlich gemacht werden.



General Safety Information

- Electric connection must be appropriate according to all applicable standards and other national and international safety and accident prevention regulations.
- Damaged luminaires must not be operated.
- No liability is accepted for damages resulting from improper use.
- Use genuine parts only for repair.
- Ensure stability of the ceiling and fastening elements.

Operation of the luminaire

- Exceeding the permissible ambient temperature will reduce the luminaire's lifecycle, resulting in premature failure in extreme cases.
- Avoid ESD problems by not routing feed-through wiring directly along the wiring of the luminaire.
- Connect control inputs of dimmable luminaires with standard cables suitable for power supply voltage.

Manipulation of our products is not permitted

Modifications, reworking, re-labelling of products as well as their package is not permitted and infringes, amongst others, our registered trademark rights. Such modifications may affect technical properties of our products, damage them and possibly cause consequential damage to other objects. The manufacturer shall not be responsible under any circumstances for damage caused by such modifications.



DIN EN IEC 61340-5-1

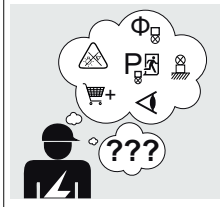

Bei Fragen zu unseren Symbolen, besuchen Sie folgende Webseite:

If you have any questions about our signs, visit the following website:



https://www.rzb.de/fileadmin/assets/downloads/PDF/RZB_Symbolklaerung.pdf

EEK

Dieses Produkt enthält eine Lichtquelle der Energieeffizienzklasse E entsprechend Verordnung (EU) 2019/2015

This product contains a light source of energy efficiency class E according to regulation (EU) No 2019/2015



Jede zersprungene Schutzabdeckung ist zu ersetzen. DIN EN 60598



Replace any cracked protective shield. IEC DIN EN 60598

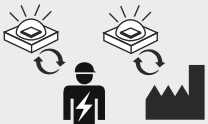

Die Lichtquelle dieser Leuchte darf nur vom Hersteller oder einem von ihm beauftragten Servicetechniker oder einer vergleichbar qualifizierten Person ersetzt werden. DIN EN 60598-1 / IEC 60598-1

The light source contained in this luminaire shall only be replaced by the manufacturer or his service agent or a similar qualified person. DIN EN 60598-1 / IEC 60598-1



Hinweis zum Einsatz von Leuchten mit D - Kennzeichnung nach EN 60598-2-24
Reference for application of lumiaires with D - marking according to EN 60598-2-24



Umgebung ohne Staubablagerung
Environment without dust deposit



Umgebung mit nicht elektrisch leitender Staubablagerung
Environment with non-electrically conductive dust deposit

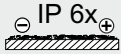

Umgebung mit elektrisch leitender Staubablagerung
Environment with electrically conductive dust deposit



Die Leuchte ist so zu positionieren, dass ein längeres in die Leuchte starren in einem geringeren Abstand als 0,5 m nicht zu erwarten ist.

The luminaire should be positioned so that prolonged staring into the luminaire at a distance closer than 0.5 m is not expected.



Zur Verwendung in Anlagen nach EN 50172 / DIN VDE 0108-100

For installation according to EN-50172 / DIN VDE 0108-100

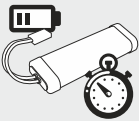

Die Sicherheitsleuchten werden generell mit entladenen oder teilentladenen Akkus ausgeliefert und müssen für die volle Funktionstüchtigkeit die vorgegebene Inbetriebnahme durchlaufen.

The emergency luminares are delivered with either discharged or only partially charged batteries and run through the specified commissioning before reaching their fully operability.



Einteilung Notleuchten

*	**	***	****
---	----	-----	------

Veränderungen am Auslieferungszustand der Leuchte sind gemäß DIN EN 60598-2-22 auf dem Typenschild zu kennzeichnen.

Classification Emergency Lighting

*	**	***	****
---	----	-----	------

Modifications to the delivery condition of the luminaire must be documented on the product label accordingly to IEC 60598-2-22.

*	Typ (1-stellig)	Type (1-digit)
X	Einzelbatterie	Self-Contained
Z	Zentralbatterie	Central Supply

**	Betriebsart (1-stellig)	Operating Mode (1-digit)
0	Notleuchte Bereitschaftsschaltung	Emergency Lighting non-maintained
1	Notleuchte Dauerschaltung	Emergency Lighting maintained
2	Kombinierte Notleuchte Bereitschaftssch.	Combi. Emergency Lighting non-maintained
3	Kombinierte Notleuchte Dauerschaltung	Combined Emergency Lighting maintained

***	Einrichtungen (max. 7-stellig)	Installation (max. 7-digit)
A	manuelle Prüfeinrichtung	Manual Test Device
B	Fernschalter für Ruhe-Zustand	Including Remote Rest Mode
C	Fernausschaltemöglichkeit	Including Inhibiting Mode
D	Arbeitsstätten m. besonderer Gefährdung	High-Risk Task-Area Luminaire
E	Lampe oder Batterie nicht austauschbar	With non-replaceable Lamps or Battery
F	automatische Prüfeinrichtung	Automatic Test Device
G	von innen beleuchtetes Sicherheitszeich.	Inside illuminated safety sign

****	Betriebsdauer (2/3-stellig) (nur bei Einzelbatterie)	Duration Time (2/3-digit) (only for self-contained)
60	Betriebsdauer 60 Minuten	Duration Time 60 Minutes
180	Betriebsdauer 180 Minuten	Duration Time 180 Minutes
480	Betriebsdauer 480 Minuten	Duration Time 480 Minutes



Anschlussplan / Wiring diagram

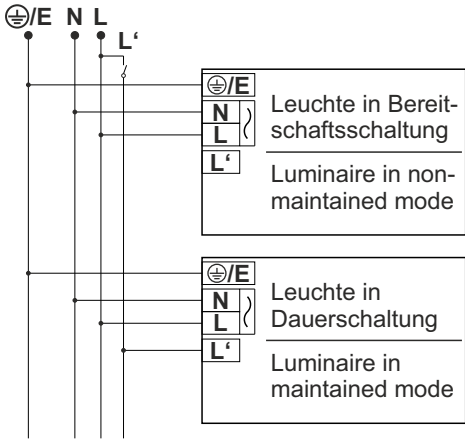

\oplus/E	Schutzleiter (SK I) // Ground Wire (IC I)
E	Erdung (SK II) // earthing (IC II)
N	Nullleiter // Neutral Wire
L	Dauerphase // Duration Wire
L'	Geschaltete Phase für Dauerschaltung Connected phase for maintained operation



Funktionsanzeige LED / Indicator LED

für Leuchten mit automatischen Selbsttest oder Bussystem
for Luminaires with automatic selftest or connecting terminal

		grün green	Netz vorhanden, Ladung OK mains available, charging OK			rot red	Leuchtmittelfehler lamp source failure
						rot red	Akkufehler battery failure
			Netz fehlt, defekte Notlichtelektronik no mains available, faulty electronic		TEST	rot-grün red-green	Testbetrieb test mode

Dauer / continuously blinkend / flashing (1Hz) Aus / off

Kontrolle nach der Installation / Check after installation

30 Minuten nach der Inbetriebnahme muss die Status-LED grün leuchten. Wenn die LED nicht leuchtet, ist die Ladung durch fehlende Netzspannung, unterbrochene Leitungen zum Akku oder defekter Ladeeinheit nicht gewährleistet.

30 minutes after start up must the green LED on. If the LED ist off, it must be detected that the charging ist not inhibited due to missing voltage supply, due to a lineinterruption to the battery or due to a faulty electronic.

Selbsttest / Automatic Test

Alle Leuchten der Baureihe enthalten ein automatisches Testsystem und überprüfen sich eigenständig. Bei den Leuchten wird wöchentlich die Einsatzbereitschaft der Elektronik, der LED und des Akkus geprüft durch Simulation eines Netzausfalls. Der erste Kapazitätstest erfolgt 8 Tage nach der Installation oder einer Fehlerbehebung. Nach dem Selbsttest muss die Status LED kontrolliert werden.

All luminaires of this series are assembled with an automatic self test system, testing the luminaires independently. Weekly tested are the electronic system, the lamps and the battery. Additionally, every year the battery capacity is measured by simulating a mains power failure. The first capacity test is performed 8 days after installation or fault repair. The indicator LED must be checked after the first self-test.

Prüfungen / Tests

Einzelbatterieleuchten sind gemäß der Vorschriften am Montageort zu testen. Mängel sind sofort zu beheben. Prüfergebnisse sind im Prüfbuch zu dokumentieren.

Self-contained luminaires hab to tested at their mounting location in compliance with the regulations. Any defekts have to be repaired immediately. Test results need to noted.

Quittieren / Acknowledging error status

Wenn beim Test Fehler auftreten, werden diese durch die farbige Status LED angezeigt. Um die Fehleranzeige nach Behebung des Fehlers zurückzusetzen, muss die Versorgungsspannung der Leuchte kurzfristig abgeschaltet werden.

If failure will displayed, these are indicated by colored status LED. Reset the error status after testing, the luminaire has to be disconnected from mains voltage temporarily.

Leuchten für die Überwachungssysteme / Luminaires for Monitoring Systems MultiDigit, MWebplus, S63

Diese Leuchten besitzen serienmäßig eine Anschlussklemme für den BUS und werden vom Hersteller mit Seriennummern codiert. Die Adresse ist auf der Leuchte vermerkt. Die Sicherheitsleuchte darf nur durch eine Leuchte mit gleicher Adresse ausgetauscht werden.

These Luminaires are assembled with a connecting terminal and are addressed with serial numbers. The number is idicated on the luminaire. The safety luminaire may only be replaced by a luminaire with the same address.

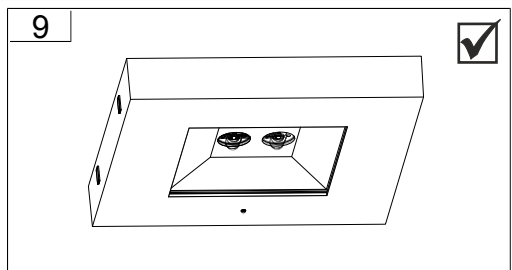
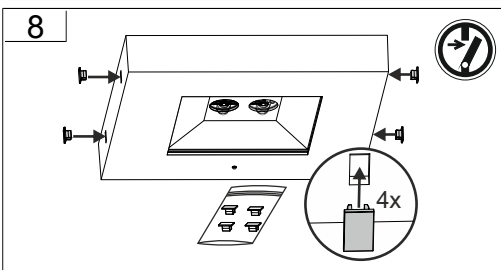
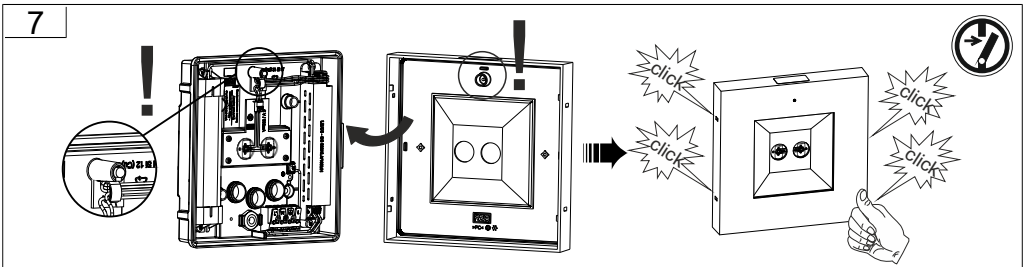
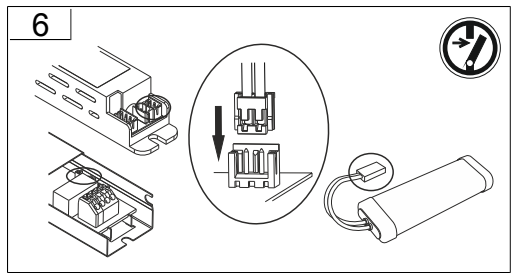
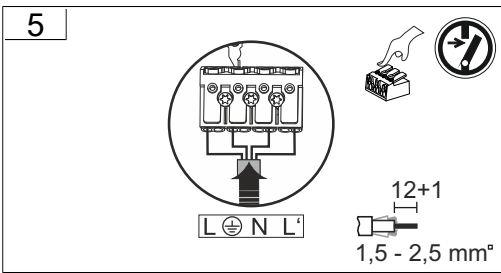
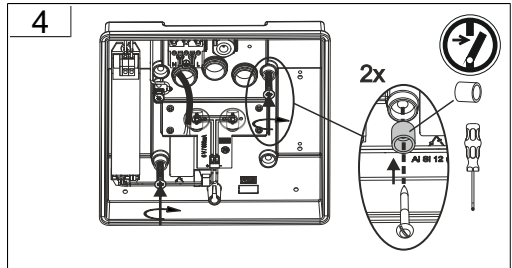
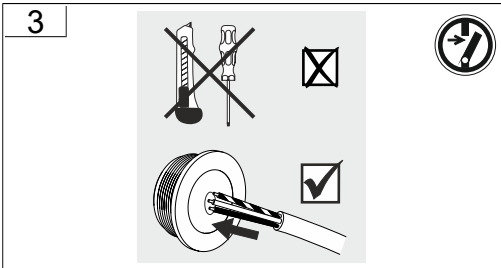
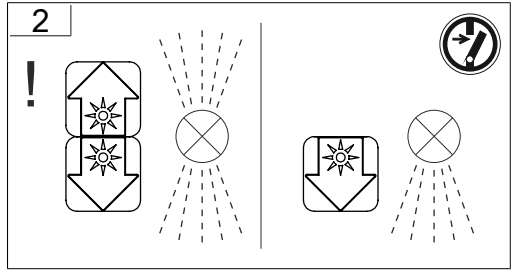
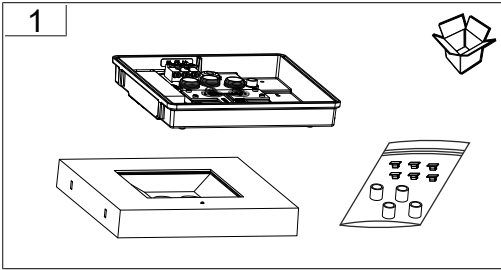

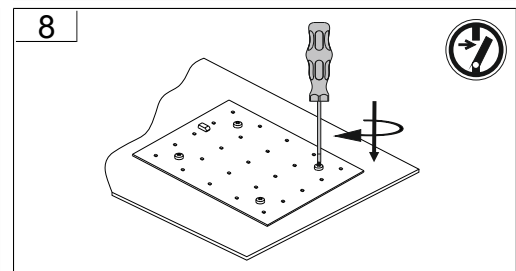
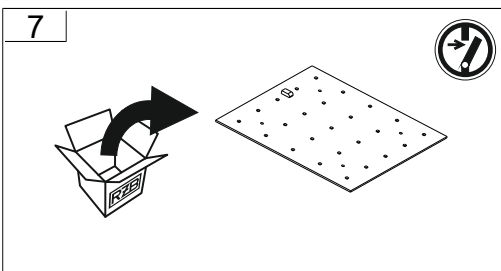
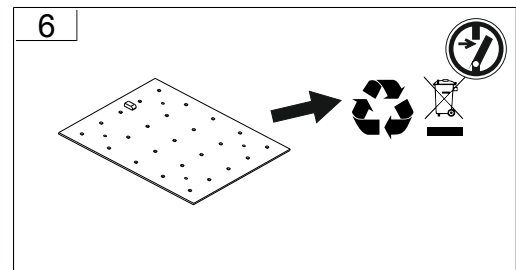
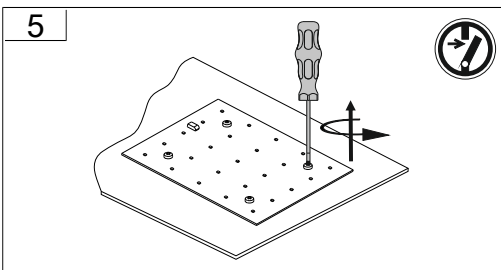
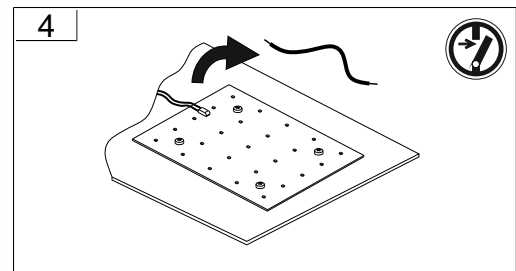
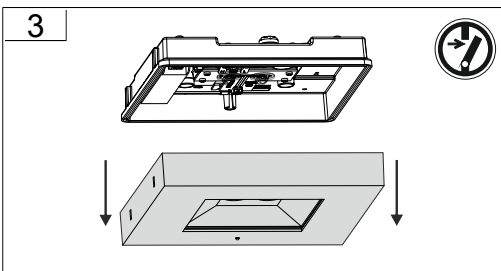
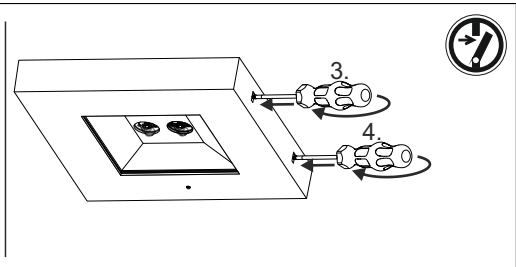
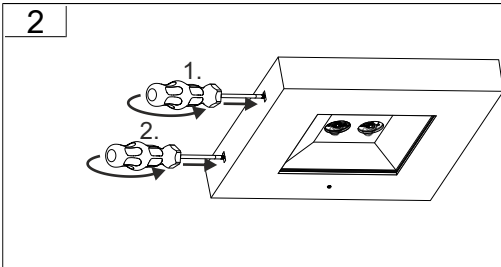
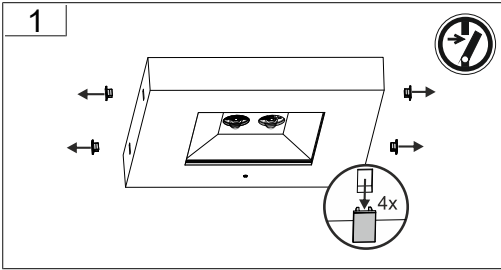

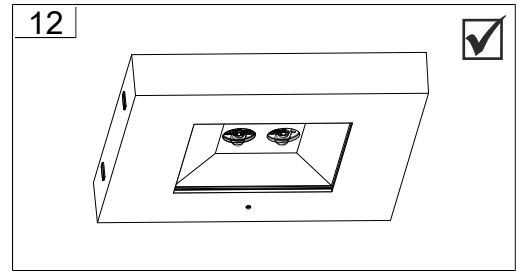
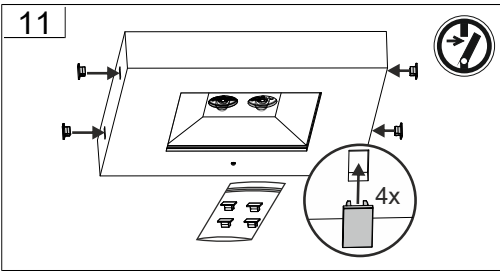
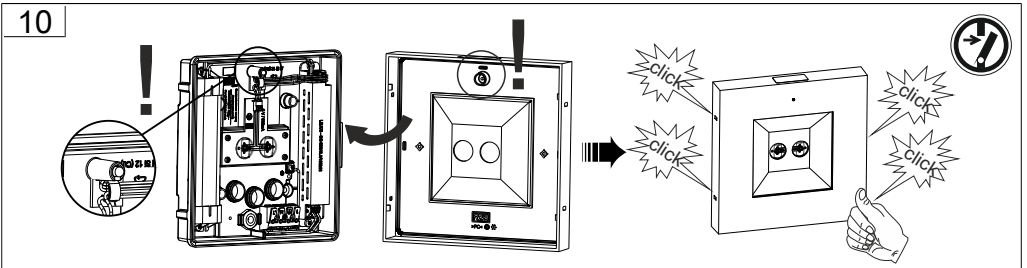
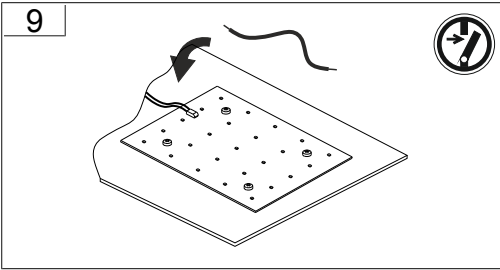

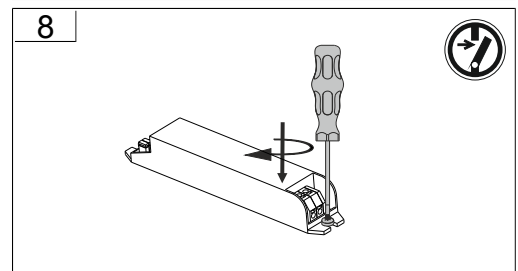
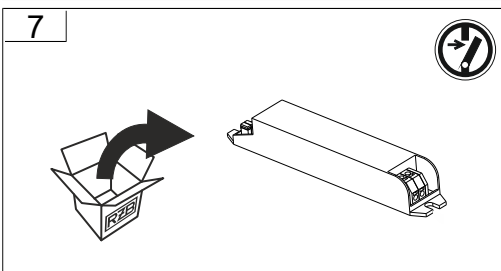
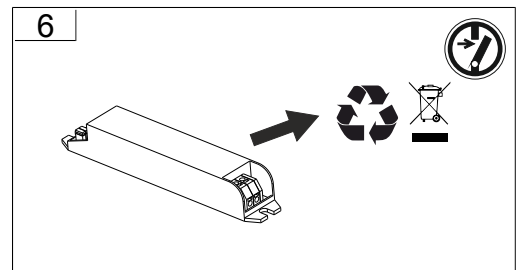
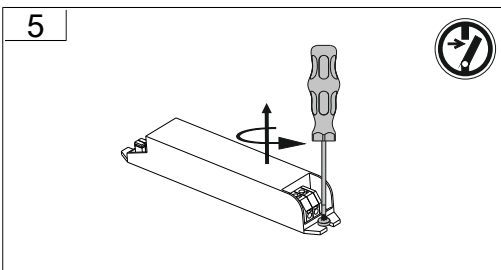
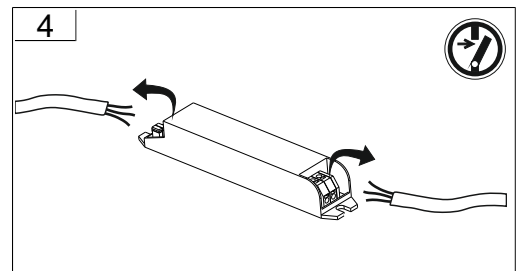
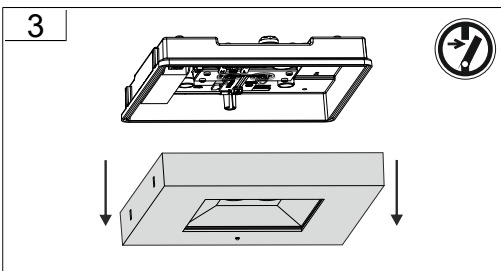
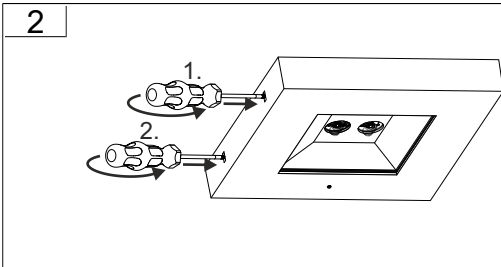
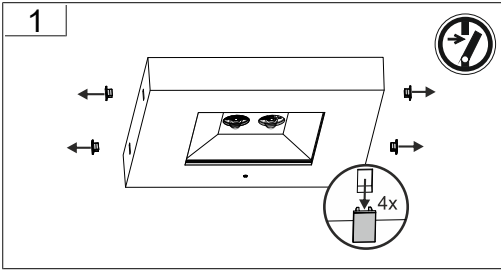

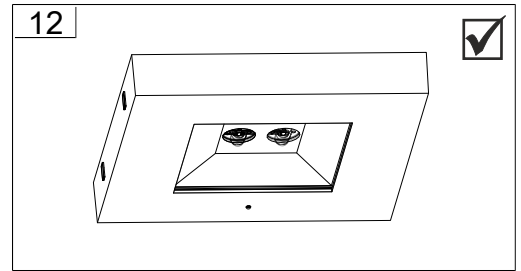
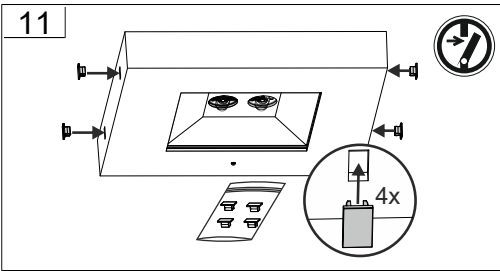
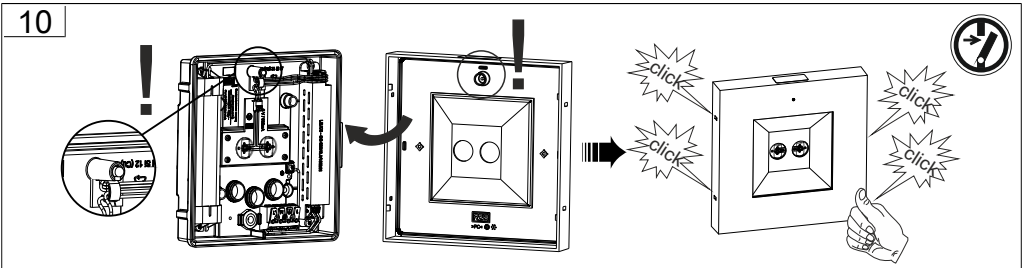
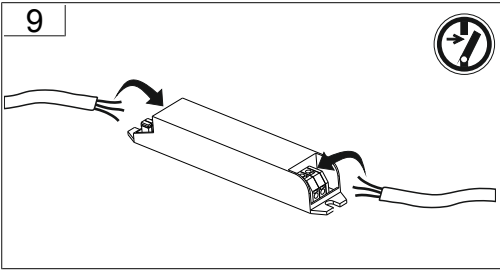

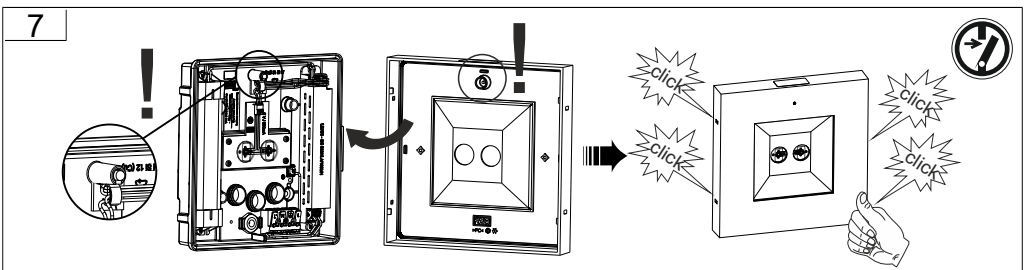
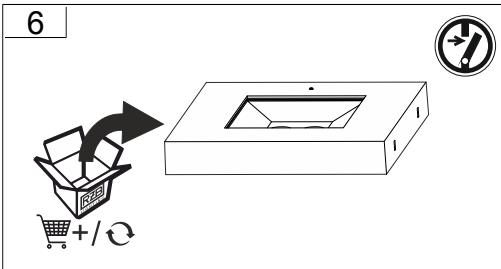
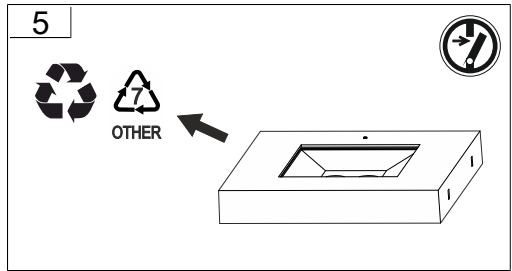
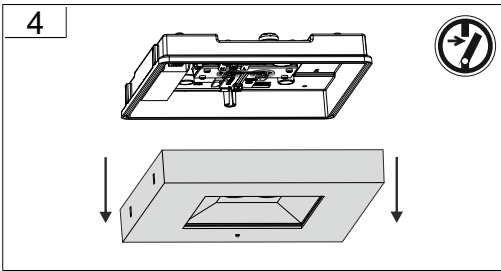
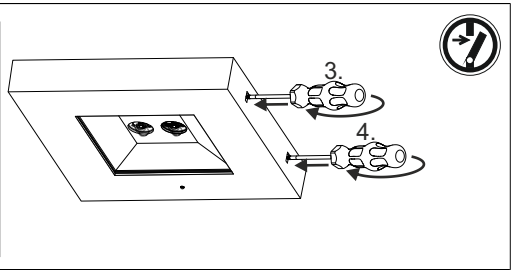
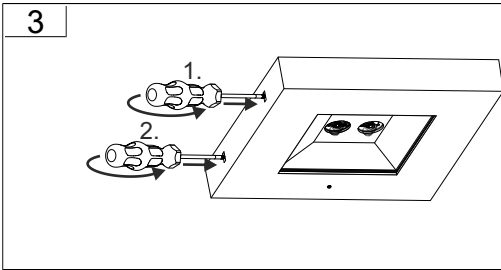
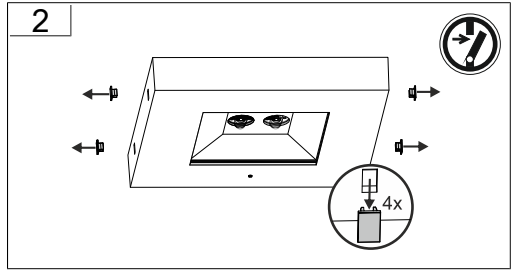
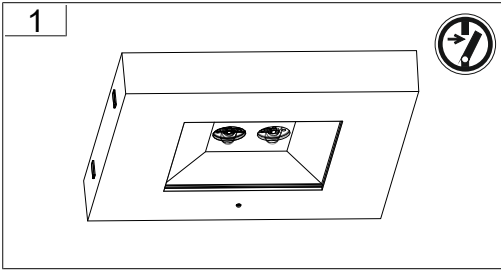

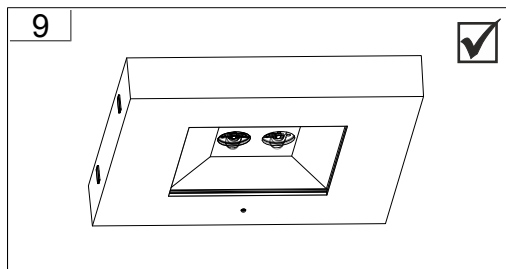
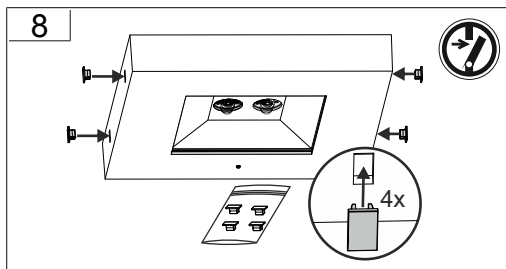

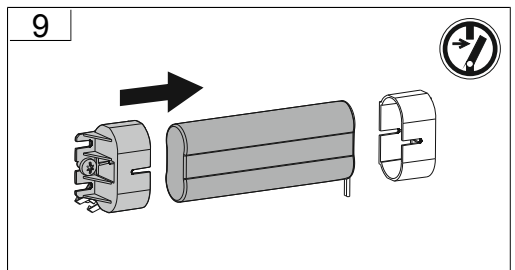
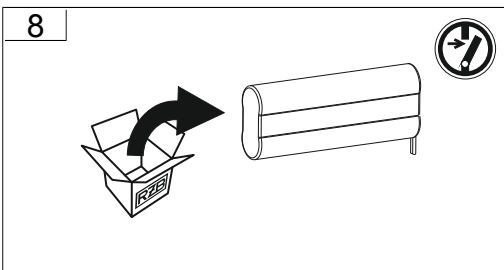
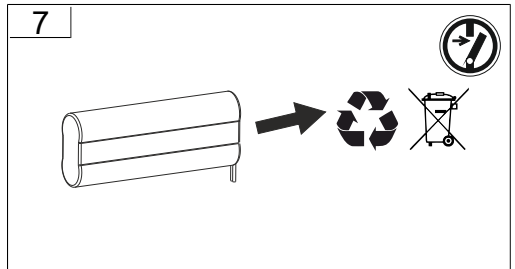
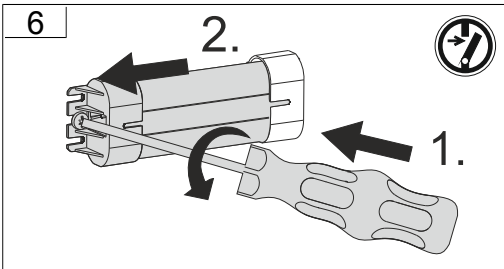
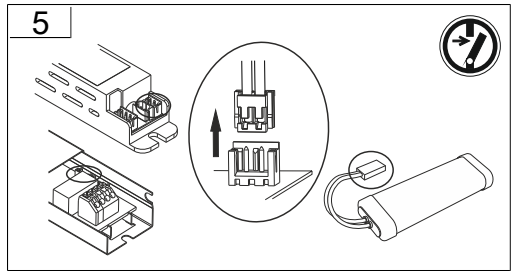
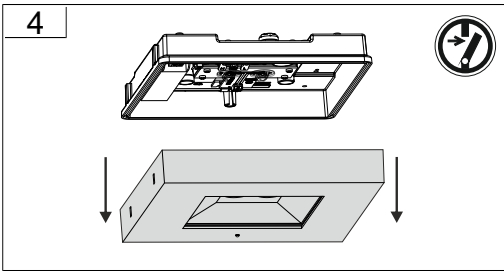
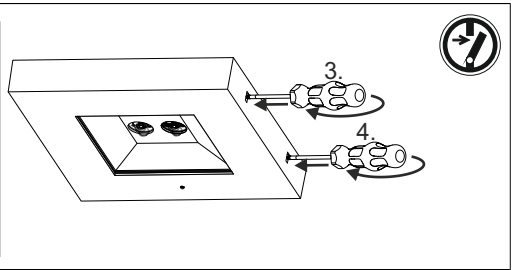
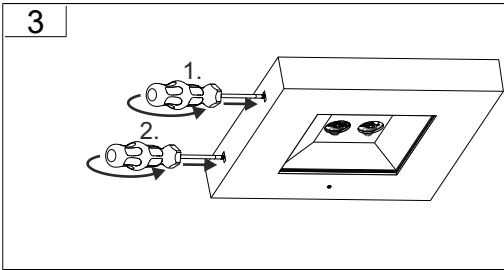
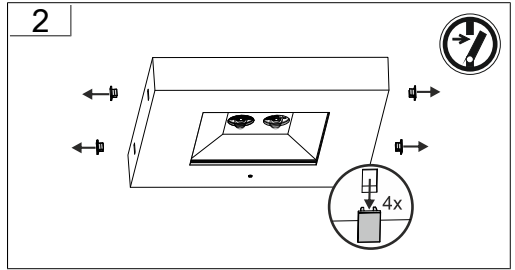
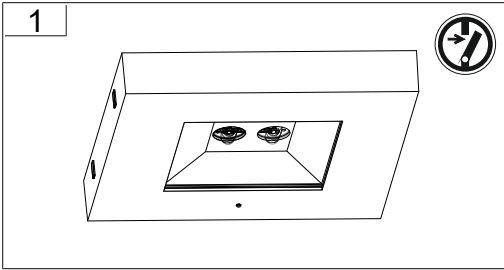
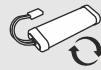

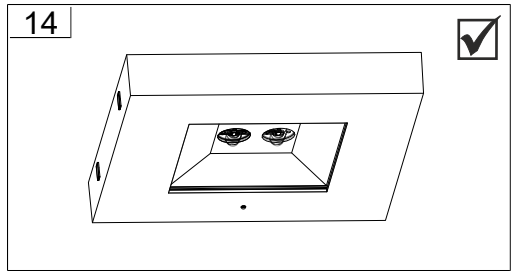
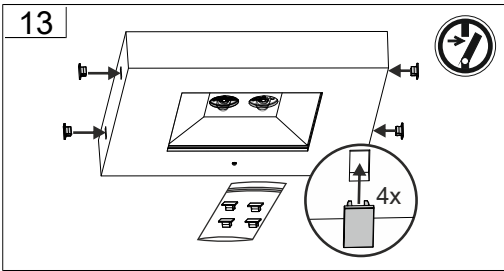
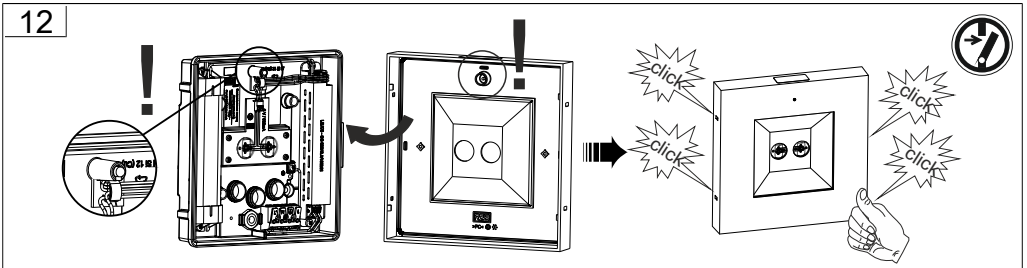
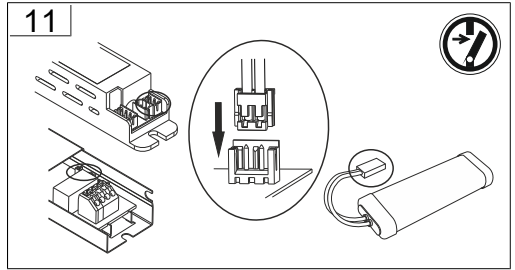
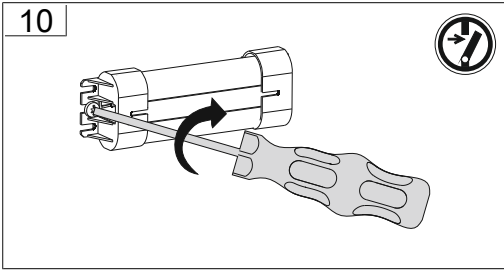

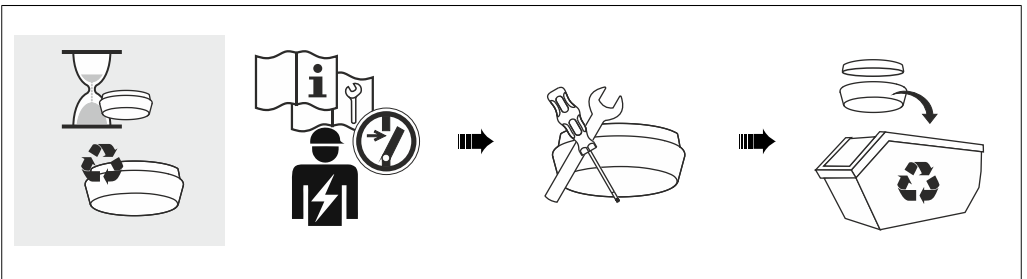
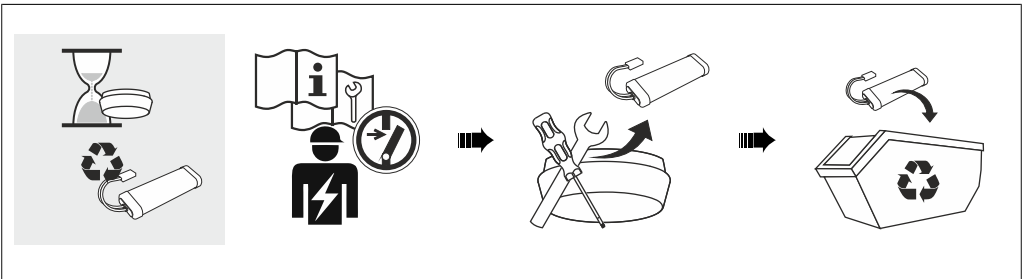
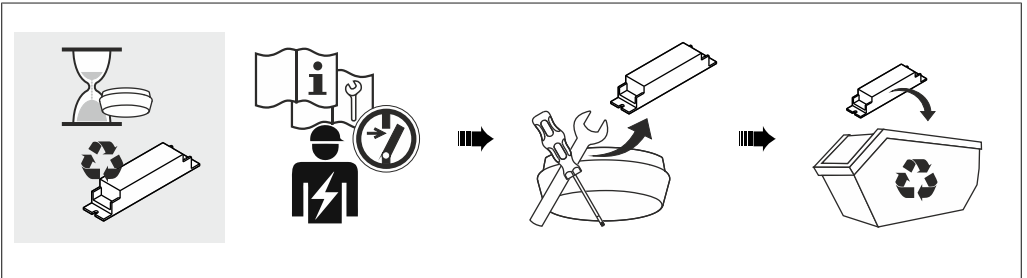
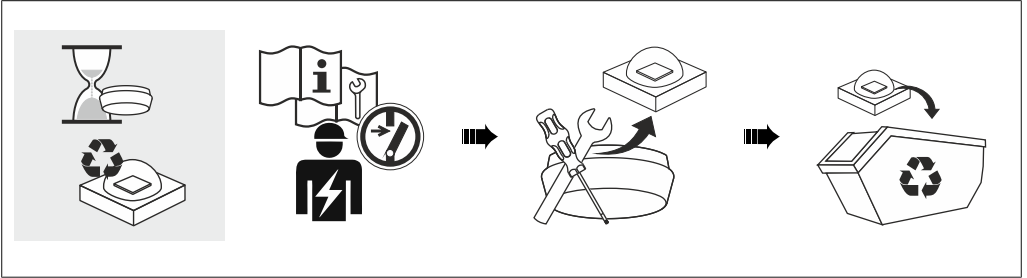





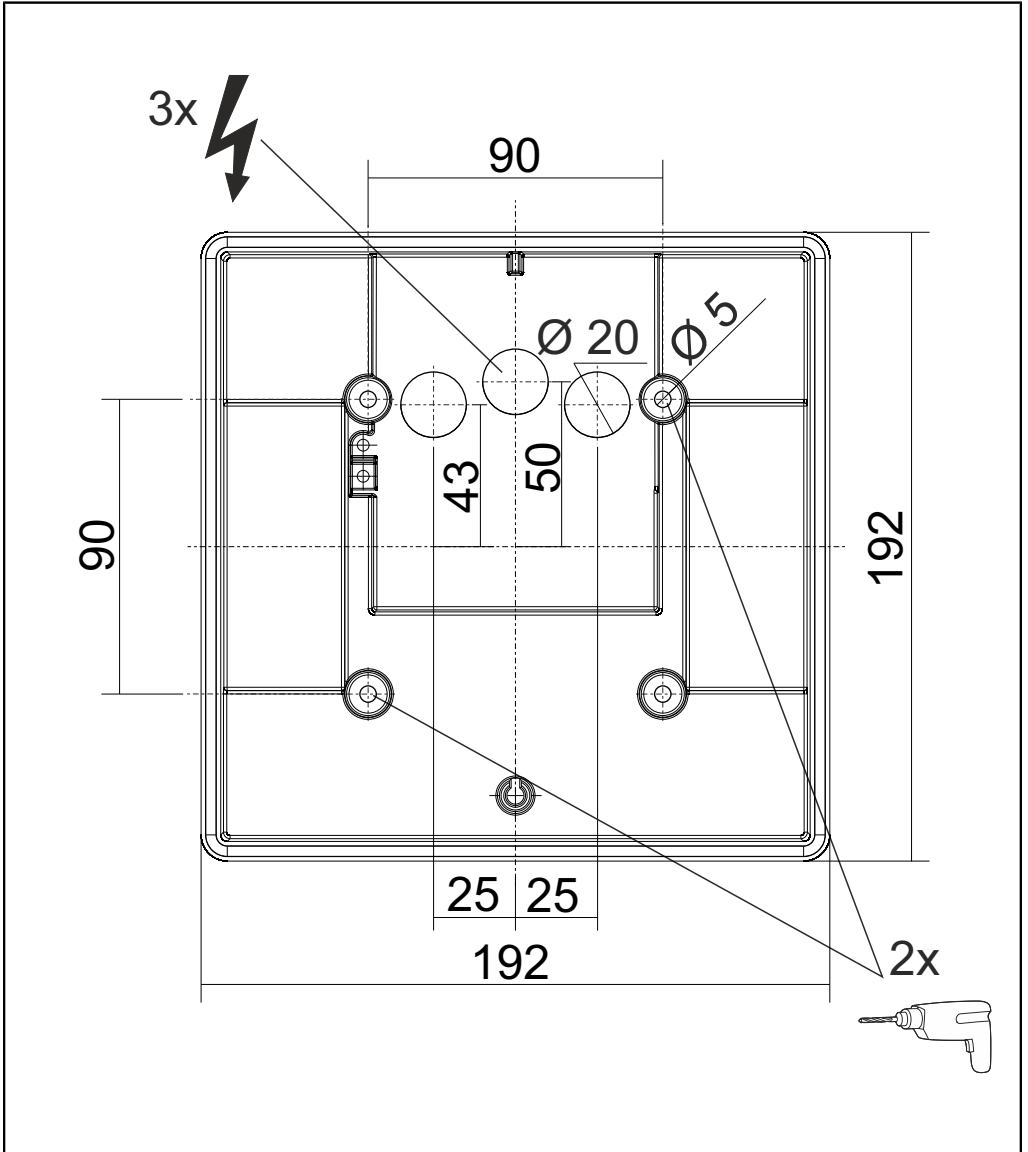



RZB - Rudolf Zimmermann, Bamberg GmbH

 Rheinstraße 16, 96052 Bamberg

 0951/7909-0

 0951/7909-198

 info@rzb-leuchten.de