

# INSTRUCTION

Rounded Midi  
582107.0031.730

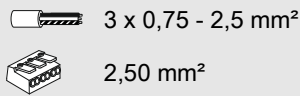

~ 220 - 240 V 50/60 Hz IP 66, IP 66 IK07



3 x 0,75 - 2,5 mm<sup>2</sup>

2,50 mm<sup>2</sup>



Umgebungstemperatur /  
temperature ambiante  
=> -20 °C ... + 50 °C

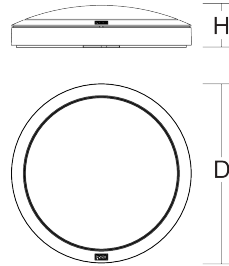

D 300, H 71



1,9 kg



$\Phi$  [lm]

$P_{\square}$  [W]

$P_{\circ}$

LED

1100

10

1 x 4 W

CCT [K]

CRI

RG  $\square$

EEK  $\square$

3000

80

RG 1

D

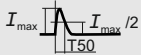

5 A / 50  $\mu$ s



31



50



52



85

cos  $\varphi$

0,95

$f_{\min}$  -  $f_{\max}$   
[MHz]

2400 - 2483

$p_{\text{EIRP}}$  [mW]

2,51

$p_{\text{EIRP}}$  [dBm]

4





### Allgemeine Sicherheitshinweise

- Der elektrische Anschluss muss ordnungsgemäß nach geltenden Normen und den nationalen sowie internationalen Sicherheits- und Unfallverhütungsvorschriften erfolgen.
- Beschädigte Leuchten dürfen nicht betrieben werden.
- Keine Haftung für Schäden durch unsachgemäßen Einsatz.
- Bei Instandsetzung nur Originalteile verwenden.
- Tragfähigkeit der Decke und Befestigungselemente sicherstellen.

### Betrieb der Leuchte

- Die unzulässigen Umgebungstemperaturen reduzieren die Lebensdauer der Leuchte, im Extremfall droht der Frühausfall.
- Zur Vermeidung von EMV-Problemen die Durchgangsverdrahtung nicht entlang der Leuchtenverdrahtung führen.
- Steuereingänge von dimmbaren Leuchten mit handelsüblichen für Netzspannung geeigneten Leitungen anschließen.

### Manipulationen unserer Produkte sind unzulässig

Veränderung, Umarbeitung, Umkennzeichnung von Produkten sowie deren Verpackung sind unzulässig und verletzen u.a. unsere eingetragenen Warenzeichenrechte. Solche Modifikationen können technische Eigenschaften unserer Produkte negativ beeinflussen, diese zerstören und möglicherweise Folgeschäden an anderen Objekten verursachen. Für durch derartige Modifikationen verursachte Schäden kann der Hersteller in keinem Fall verantwortlich gemacht werden.



### General Safety Information

- Electric connection must be appropriate according to all applicable standards and other national and international safety and accident prevention regulations.
- Damaged luminaires must not be operated.
- No liability is accepted for damages resulting from improper use.
- Use genuine parts only for repair.
- Ensure stability of the ceiling and fastening elements.

### Operation of the luminaire

- Exceeding the permissible ambient temperature will reduce the luminaire's lifecycle, resulting in premature failure in extreme cases.
- Avoid ESD problems by not routing feed-through wiring directly along the wiring of the luminaire.
- Connect control inputs of dimmable luminaires with standard cables suitable for power supply voltage.

### Manipulation of our products is not permitted

Modifications, reworking, re-labelling of products as well as their package is not permitted and infringes, amongst others, our registered trademark rights. Such modifications may affect technical properties of our products, damage them and possibly cause consequential damage to other objects. The manufacturer shall not be responsible under any circumstances for damage caused by such modifications.



Bei Fragen zu unseren Symbolen, besuchen Sie folgende Webseite:

If you have any questions about our signs, visit the following website:



[https://www.rzb.de/fileadmin/assets/downloads/PDF/RZB\\_Symbolklaerung.pdf](https://www.rzb.de/fileadmin/assets/downloads/PDF/RZB_Symbolklaerung.pdf)

**EEK**

Dieses Produkt enthält eine Lichtquelle der Energieeffizienzklasse D entsprechend Verordnung (EU) 2019/2015

This product contains a light source of energy efficiency class D according to regulation (EU) No 2019/2015



Jede zersprungene Schutzabdeckung ist zu ersetzen. DIN EN 60598

Replace any cracked protective shield. IEC DIN EN 60598

Hinweis zum Einsatz von Leuchten mit D - Kennzeichnung nach EN 60598-2-24  
Reference for application of lumiaires with D - marking according to EN 60598-2-24

IP 4x

Umgebung ohne Staubablagerung  
Environment without dust deposit

IP 5x

Umgebung mit nicht elektrisch leitender Staubablagerung  
Environment with non-electrically conductive dust deposit

IP 6x

Umgebung mit elektrisch leitender Staubablagerung  
Environment with electrically conductive dust deposit



IP 66



IP 66

## Reichweite Range

Funk-Sender / Empfänger  
transmitter / receiver

Betriebsfrequenzen: 2,4 ... 2,483 GHz  
Operating Conditions:

Max. Ausgangsleistung: + 4 dBm  
Max. Output power:

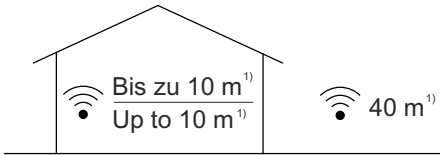

<sup>1)</sup>Die Reichweite ist stark von den umliegenden Hindernissen wie Wänden und den Baumaterialien abhängig.

Range is highly dependant on the surrounding and obstacles such as walls and building materials.



Kompatible Geräte:  
Compatible devices:

- ✓ iPhone 4S oder später  
or later
- ✓ iPod 3 oder später  
or later
- ✓ iPod Touch 5th Gen. oder später  
or later
- ✓ Android 4.4 oder später produziert als  
KitKat 2013 mit kompletter Blue-  
tooth 4.0 Unterstützung  
or later devices produced  
after 2013 with full BT 4.0  
support

Mit Casambi Mesh Network Technologie agiert jede Steuereinheit auch als ein Repeater. Durch den Einsatz mehrerer Casambi Units können größere Reichweiten erreicht werden.

Casambi uses mesh network technology so each CBU-ASD acts also as a repeater. Longer ranges can be achieved by using multiple Casambi units.



Die Reichweite des Funksignals hängt von der Umgebung ab, z.B. Leuchte, Möbel, Menschen oder der Gebäudekonstruktion. Sie muss in der Installation geprüft und abgenommen werden.

The range of the radio signal depends on the environment, e.g. on luminaire, building construction, furniture or people. It must be testes and approved in the installation.



Um eine gute Funkverbindung zu gewährleisten, darf die Steuereinheit nicht komplett mit Metall verdeckt werden!

To ensure a good radio connection, the control unit must not be completely covered with metal!



## Erstmalige Anwendung



Die Casambi App ist leicht zu installieren. Folgen Sie einfach diesen Schritten:

### First time use

Casambi app is easy to use. Follow these simple steps:

1. Casambi- App aus dem Apple App Store oder Google Play Store downloaden.  
Download the app from Apple App Store or Google Play Store.
2. Smart + free- Steuereinheit betriebene Leuchte einschalten  
Switch on your Casambi enabled luminaires.
3. App öffnen.  
Open the app.
4. Die App findet automatisch die Leuchten, die eingeschaltet sind  
Casambi app will automatically find all Casambi enabled luminaires that are switched on.
5. Klicken Sie auf „Alle Leuchten in Benutzung nehmen“.  
Click on „Take all lamps into use“.
6. Die Leuchten werden automatisch zu einem Netzwerk hinzugefügt.  
Casambi app will automatically add all found luminaires to one network and open the „Lamps“ tab.
7. Vergeben Sie eine von vier Freigabeoptionen für ihr Netzwerk (siehe Seite „Netzwerke und Freigabe“)  
Assign one of four sharing options for your network (see page „Network setup and sharing“).

## Zusatzinfo

### Additional info



Link zum iOS  
Link to iOS



Link zum Android  
Link to Android



Link zur weiteren  
Information



Link to more  
information



**EG-Konformitätserklärung**  
**EC-Declaration of Conformity**  
**Déclaration UE de conformité**  
**Declaración de conformidad CE**  
**Deklaracja zgodności UE**



**Hersteller, Anschrift:**  
**Manufacturer, address:**  
**Fabricant, adresse:**  
**Fabricante, dirección:**  
**Producent, adres:**

**RZB Rudolf Zimmermann, Bamberg GmbH**  
**Rheinstrasse 16**  
**96052 Bamberg**  
**Deutschland / Germany / Allemagne / Alemania / Niemcy**

Wir erklären in alleiniger Verantwortung, dass das Produkt  
 We declare under sole responsibility that the product  
 Nous déclarons, sous notre propre responsabilité, que le produit  
 Declaramos bajo nuestra sola responsabilidad que el producto  
 Deklarujemy z pełną odpowiedzialnością, że produkt

**Produktbezeichnung:**  
**Product designation:** **Rounded Midi**  
**Description des produits:**  
**Designación de producto:** **582107.0031.730**  
**Oznaczenie produktu:**

mit den folgenden EG-Richtlinien und Normen übereinstimmt:  
 complies with the following EC Directives and standards:  
 est conforme aux normes et directives de l'UE suivantes:  
 cumple con las siguientes directivas y normas CE:  
 jest zgodny z następującymi dyrektywami UE i normami:

<p><b>RED Directive</b> 2014/53/EU</p>	<p><b>(3.1a)</b> EN 60598-1:2021/A11:2022 EN 60598-2-1:1989 EN 62471:2008 EN 62493:2010 <b>(3.1b)</b> EN 301 489-1:V2.2.3 EN 301 489-17:V3.2.4 EN 55015:2019/A11:2020 EN 61000-3-2:2019/A1:2021 EN 61000-3-3:2013+A1:2019+A2:2021+A2:2021/AC:2022 EN 61547:2023 <b>(3.2)</b> EN 300 328:V2.2.2</p>
<p><b>RoHS Directive</b> 2011/65/EU</p>	<p>EN 63000:2018</p>
<p><b>ErP Directive</b> 2009/125/EC</p>	<p>(EU) 2019/2020</p>

Dokument-Nr. / Document No. / Document No. **24002401**  
 Document No. / Nr dokumentu

Aussteller / Issuer / Délivré par: **RZB Rudolf Zimmermann, Bamberg GmbH**  
 Orotgante / Wystawca:

Ort, Datum / Place, Date / Lieu, date: **Bamberg, 02.02.2024**  
 Lugar, Fecha / Miejsce, data:

Rechtsverbindliche Unterschrift:  
 Legally binding signature:  
 Signature juridiquement obligatore:  
 Firma legalmente vinculante:  
 Prawnie wiązacy podpis:

  
 Reiner Jürgens  
 CEO/Direktor Zarządzający/Geschäftsführer

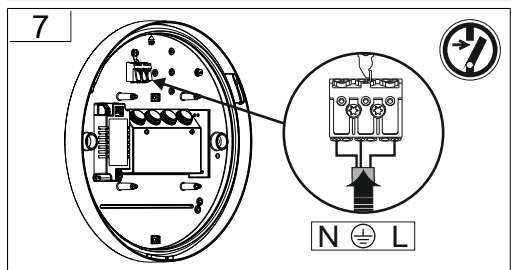
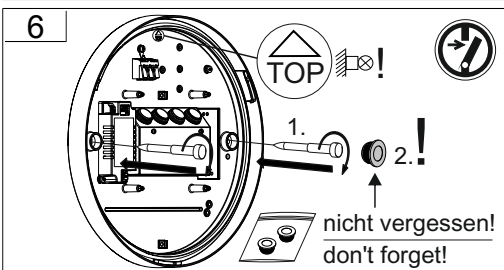
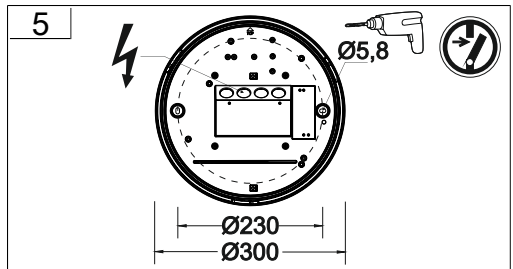
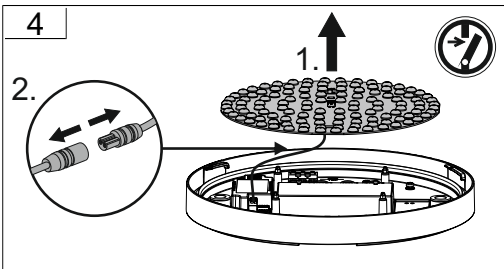
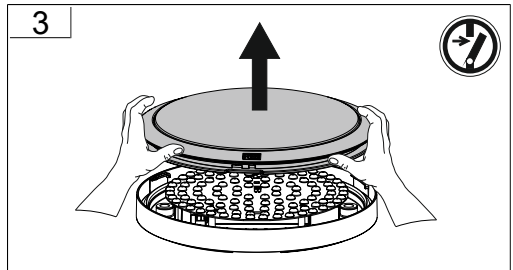
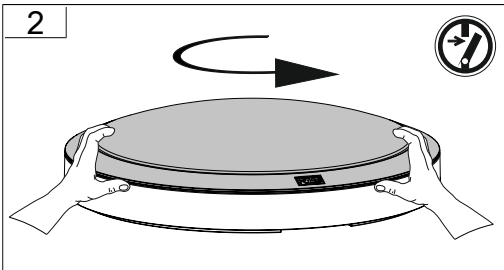
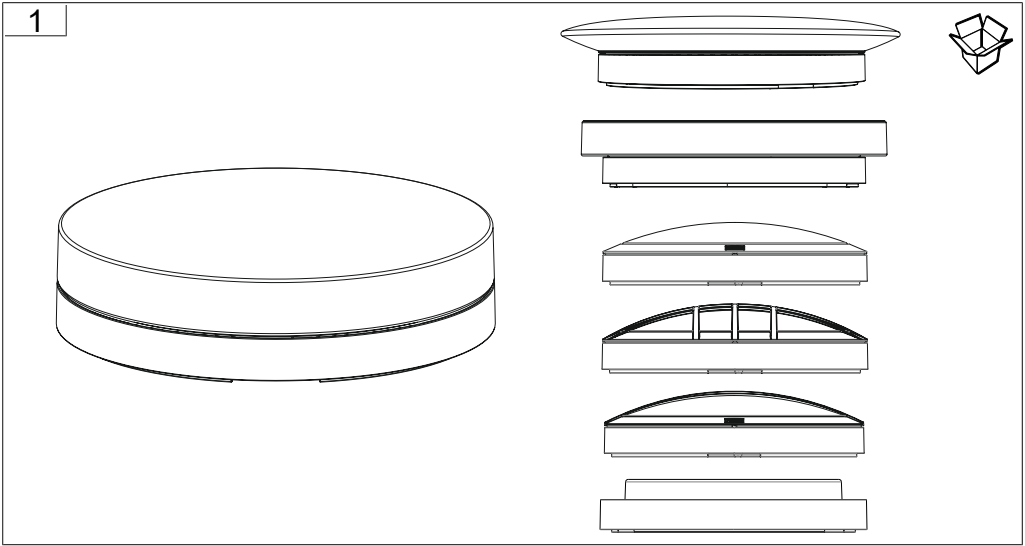
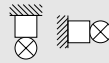



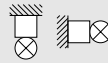

8

Konvertereinstellung / Converter setting

SEC	1	2	3	4	
250 mA	-	-	-	-	3000K → 1100-1150lm
280 mA	-	-	-	ON	4000K → 1100-1200lm
310 mA	-	-	ON	-	
340 mA	-	-	ON	ON	
370 mA	-	ON	-	-	
400 mA	-	ON	-	ON	
430 mA	-	ON	ON	-	
460 mA	-	ON	ON	ON	
490 mA	ON	-	-	-	
520 mA	ON	-	-	ON	
550 mA	ON	-	ON	-	
580 mA	ON	-	ON	ON	
610 mA	ON	ON	-	-	
640 mA	ON	ON	-	ON	
670 mA	ON	ON	ON	-	3000K → 3000-3150lm
700 mA	ON	ON	ON	ON	4000K → 3100-3250lm

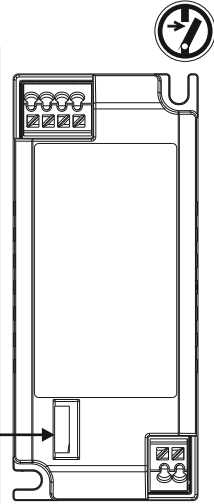

9

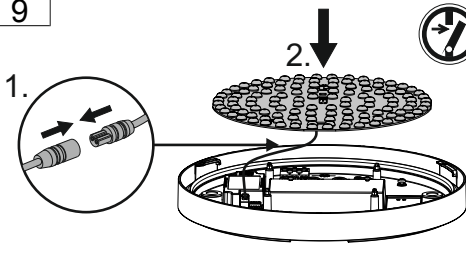

10

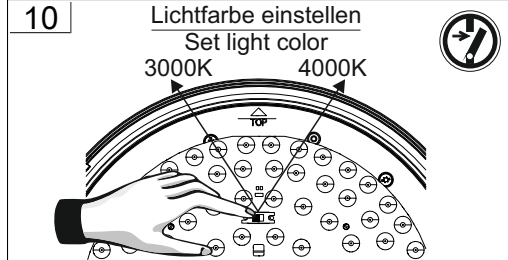

11

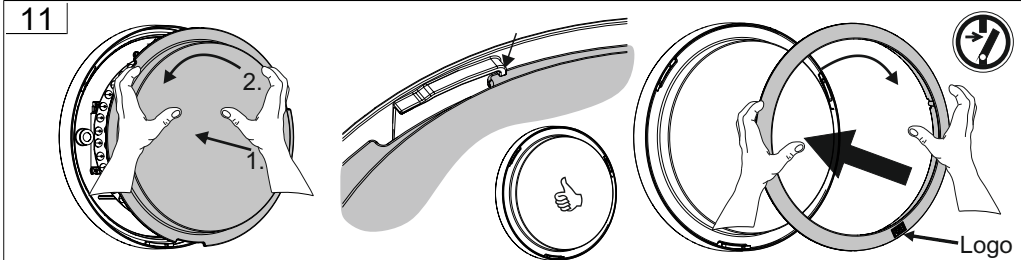

12

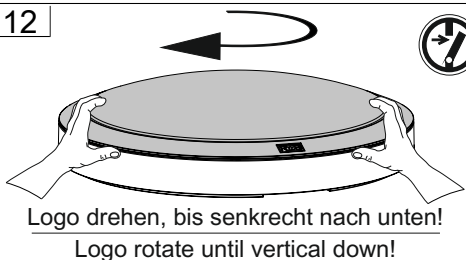

13

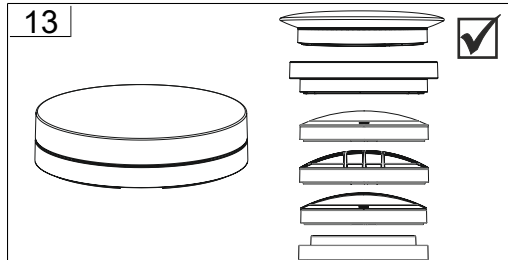

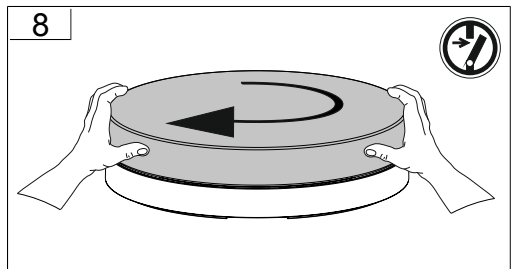
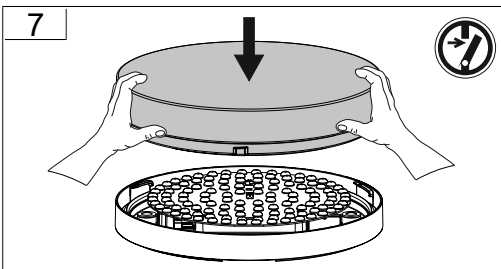
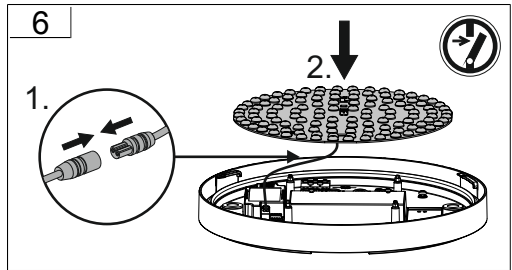
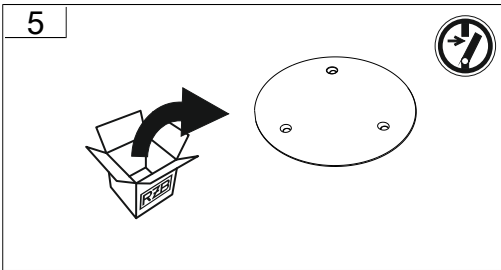
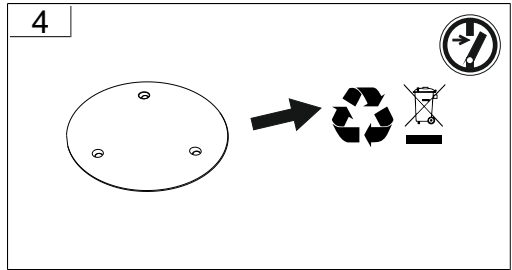
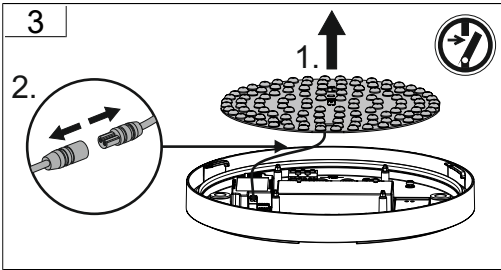
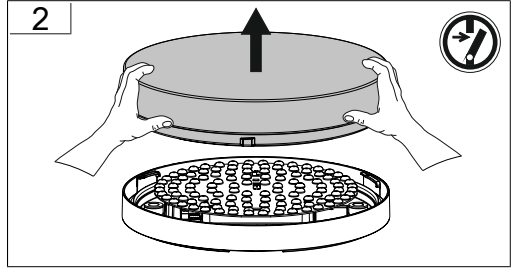
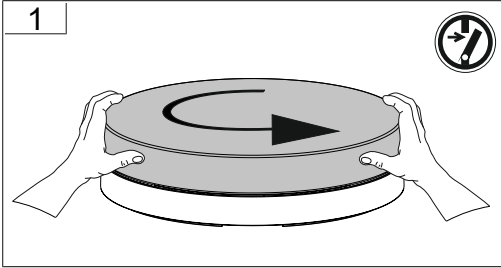

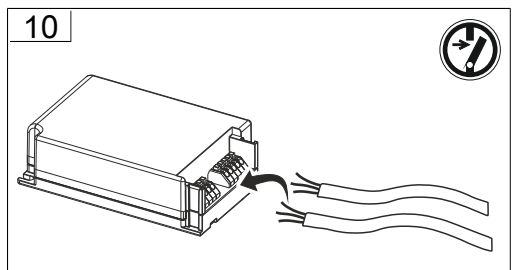
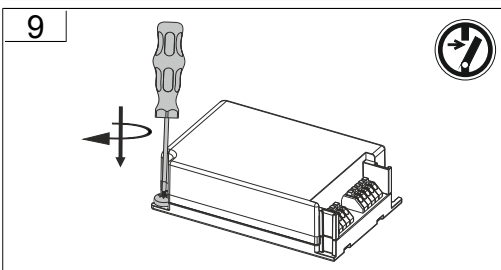
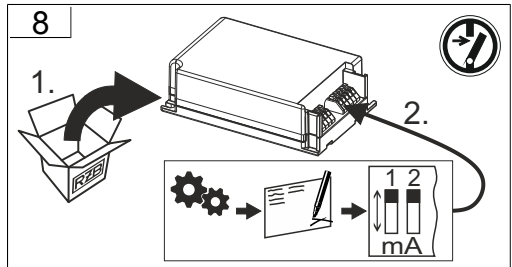
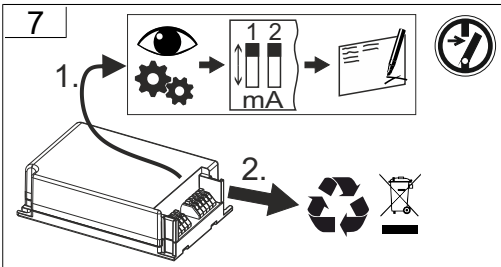
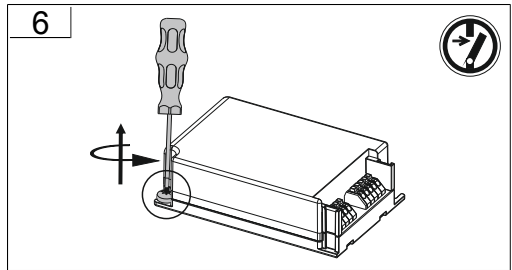
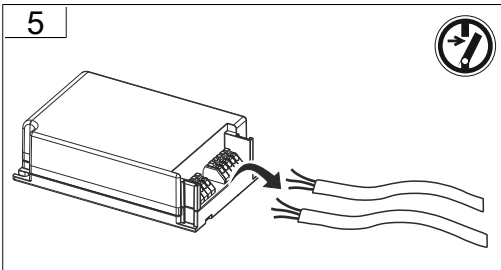
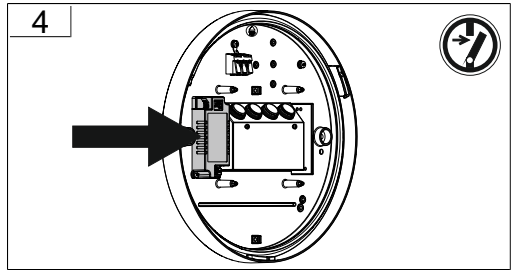
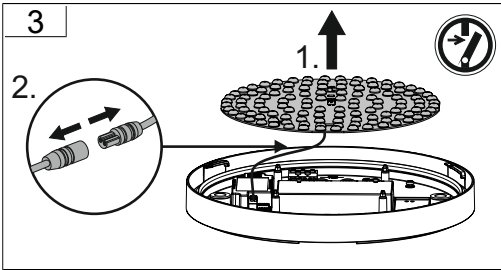
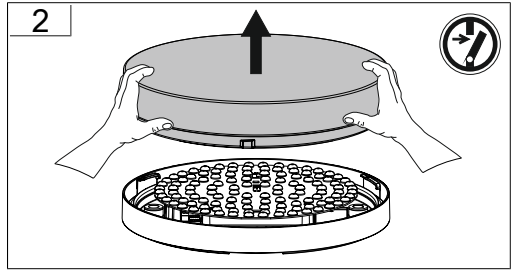
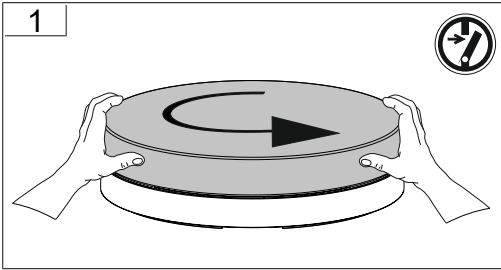

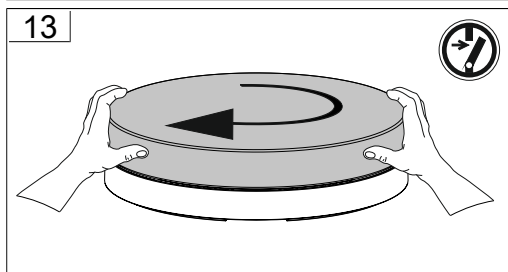
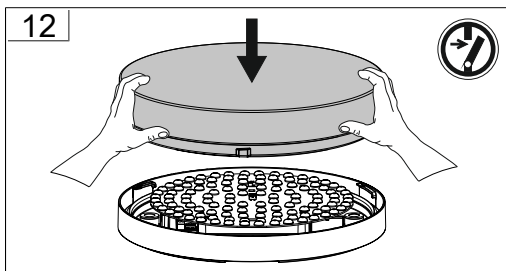
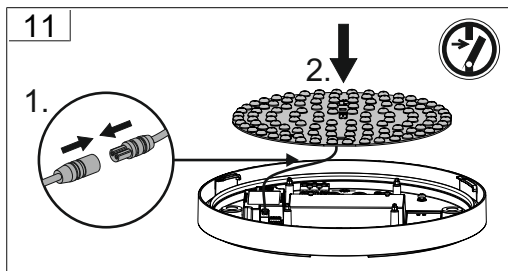

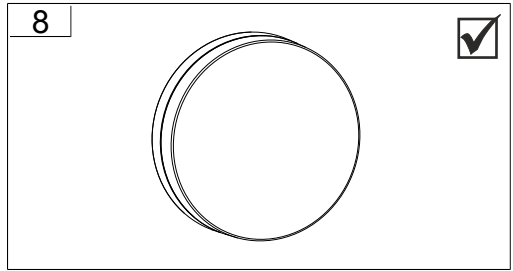
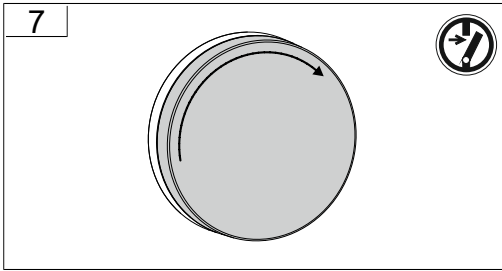
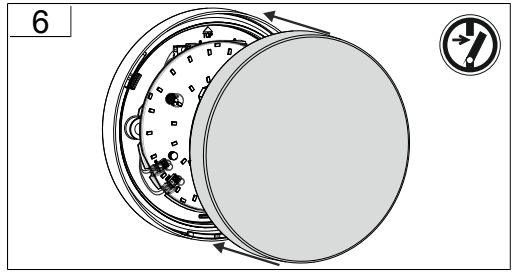
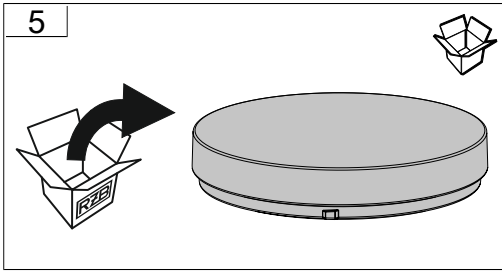
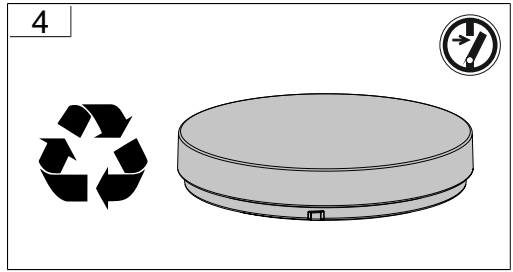
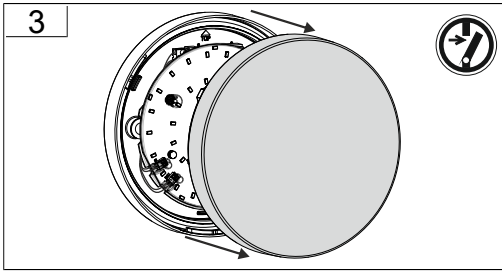
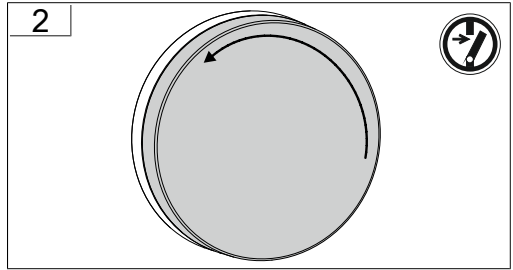
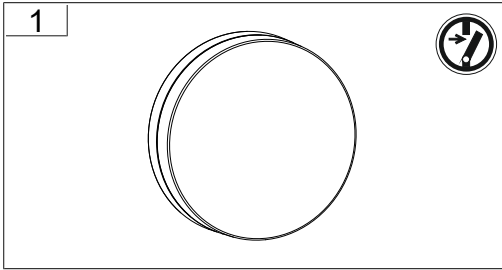

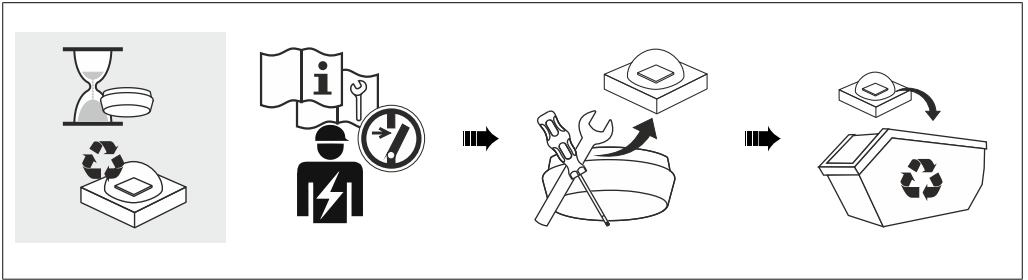



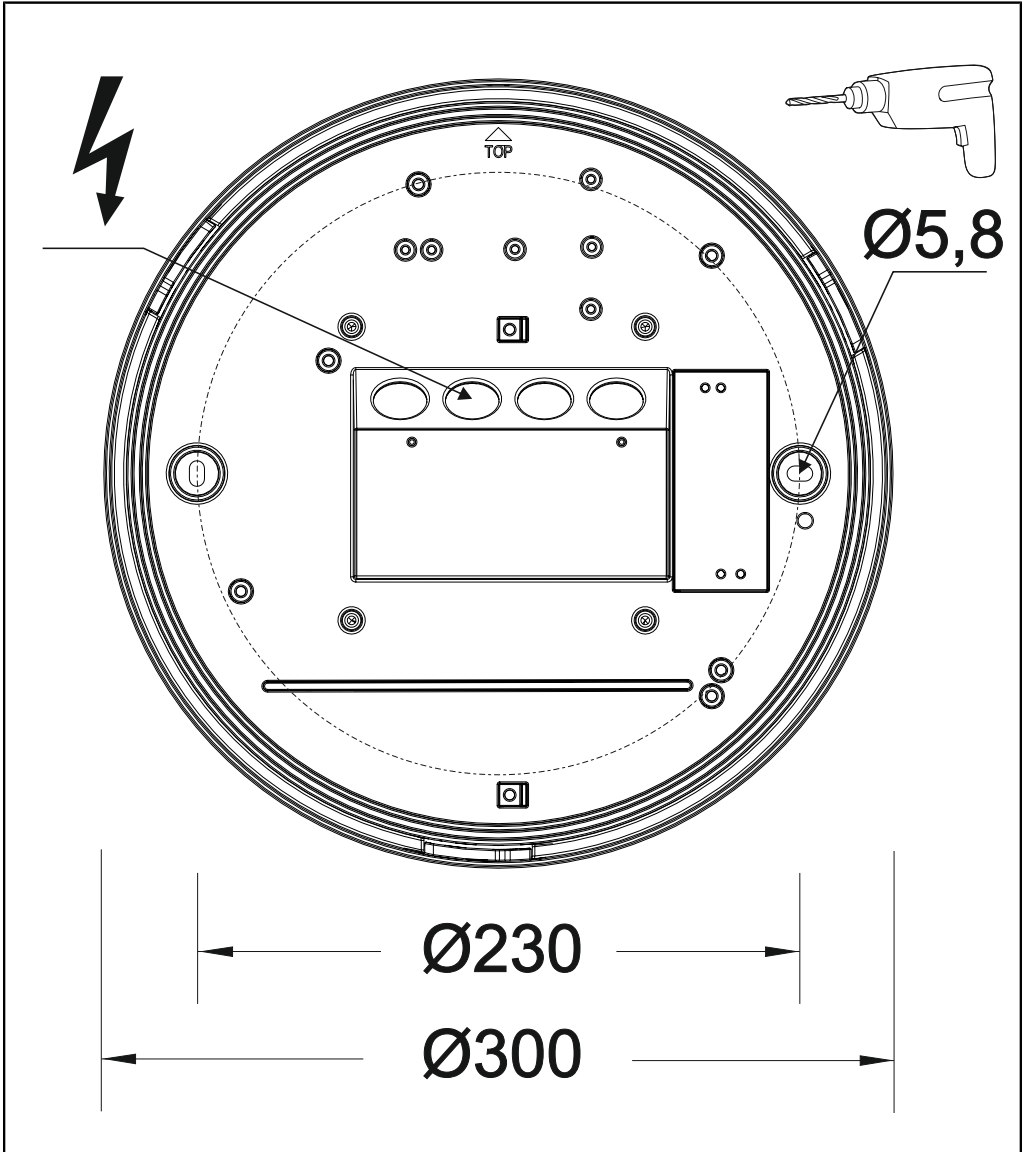

RZB - Rudolf Zimmermann, Bamberg GmbH

🏠 Rheinstraße 16, 96052 Bamberg

☎ 0951/7909-0

📠 0951/7909-198

🌐 [info@rzb-leuchten.de](mailto:info@rzb-leuchten.de)