

# Product Data Sheet

## GW94422

90 RCD Range



Description	RESIDUAL CURRENT DEVICE
Code	BD
No. of poles	4P
No. modules	3.5
Rated current	25 A
Rated residual operating current	30 mA
Type	AC
Rated voltage (IEC/EN 61009-1 app. G, IEC/EN 61009-2-1 app. G)	400 V

Standard	IEC/EN 61009-1 app. G, IEC/EN 61009-2-1 app. G	Rated frequency (Hz)	50/60 Hz
Insulation voltage	500 V	Rated impulse withstand voltage	4 kV
Overvoltage category	III	Level of immunity (8/20 μs)	250 A
Section rigid cable	Max 35 mm <sup>2</sup>	Section flexible cable	Max 35 mm <sup>2</sup>
Operating temperature	-25 +40 °C	Stocking temperature	-40 +70 °C
Rated tightening torque	2 Nm	Assembly position	Any

### DIMENSIONAL

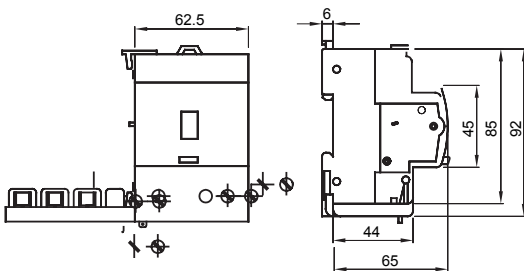

### WIRING DIAGRAM

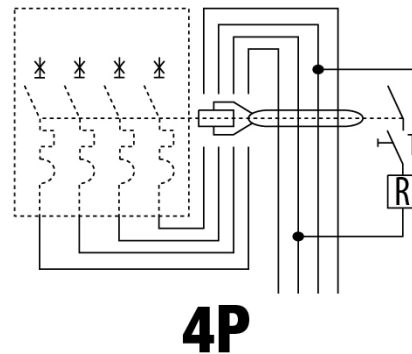

### STANDARDS/APPROVALS

