

# PRODUCT DATASHEET

## DL SURFACE IP65 DN 250 P 45W 830 60D WT

DOWNLIGHT SURFACE IP65 | Surface-mounted downlights with IP65 grade



PERFOR-  
MANCE  
CLASS

### Areas of application

- Direct replacement for luminaires with fluorescent lamps
- Suitable for indoor and outdoor installations
- Corridors, stairways, entrance areas
- Passages, underpasses
- Public areas

### Product benefits

- Suitable for use in dusty and damp locations thanks to high IP rating
- Suitable for use in public areas thanks to high IK rating
- 5 years guarantee
- Energy savings of up to 50 % (compared to luminaires that use fluorescent lamps)

### Product features

- Impact resistance: IK06
- Push wire terminal for tool-free connection
- Through wiring possible
- Type of protection: IP65
- Luminous flux: up to 4,950 lm
- High luminous efficacy: up to 110 lm/W
- Lifetime (L70/B50): 100,000 h (at 25 °C)



– Ambient temperature in operation: -30...+40 °C

## TECHNICAL DATA

### Electrical data

Nominal wattage	45.00 W
Nominal voltage	220...240 V
Mains frequency	50...60 Hz
Nominal current	220.000 mA
Inrush current	31 A
Inrush current time $T_{h50}$	420 $\mu$ s
Max. number of luminaires per miniature circuit breaker B16	9
Max. number of luminaires per miniature circuit breaker C10	6
Max. number of luminaires per miniature circuit breaker C16	9
Power factor $\lambda$	> 0.90
Total harmonic distortion	< 20 %
Protection class	I
Operating mode	Integrated driver

### Photometrical data

Luminous flux	4725 lm
Luminous efficacy	105 lm/W
Color temperature	3000 K
Light color (designation)	Warm White
Color rendering index Ra	> 80
Standard deviation of color matching	$\leq 6$ sdc <sub>m</sub>
Low flicker	Yes
Photobiological safety group acc. to EN62778	RG0
Photobiological safety group acc. to EN62471	RG1
Beam angle	60 °
UGR	< 19

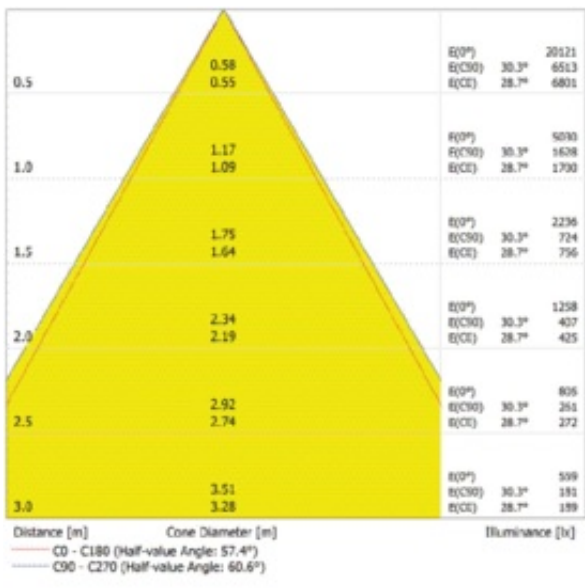

DL SURFACE DN250P 45W 60D IP65

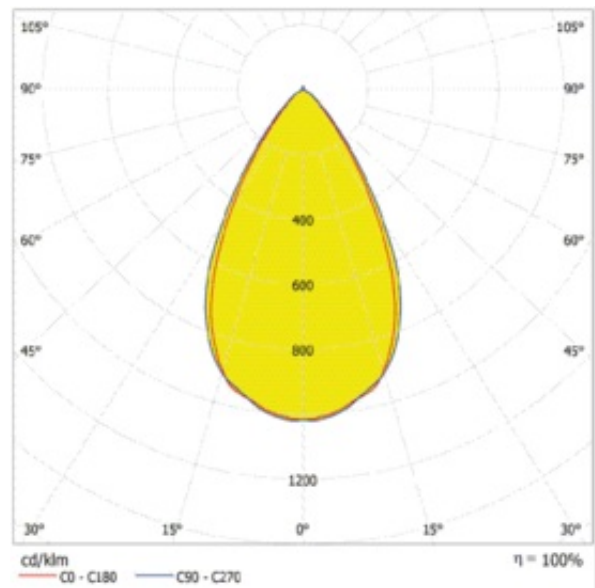

DL SURFACE 60D IP65

Dimensions & Weight

Diameter	250.00 mm
Height	125.00 mm
Product weight	2800.00 g

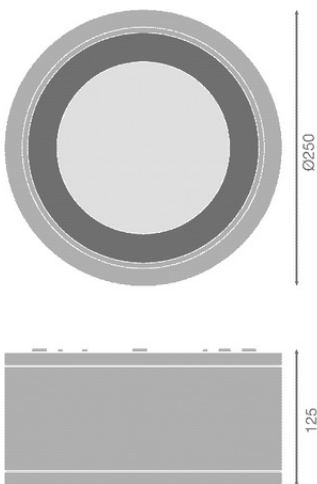

DL SURFACE DN250P 45W IP65  
WT

## Materials & Colors

Product color	White
Housing color	White
Body material	Aluminum Polycarbonate (PC)
Cover material	Polycarbonate (PC)
Light emitting surface material	Glass
Glow Wire Test according to IEC 60695-2-12	650 °C
Mercury content	0.0 mg

## Application & Mounting

Ambient temperature range	-20...+40 °C
Temperature range at storage	-30...+80 °C
Type of connection	Terminal, 3-Pole (L, N, PE)
Type of protection	IP65/IP65
Protection class IK (shock resistance)	IK06
Dimmable	No
Mounting type	Surface
Mounting location	Ceiling
Application environment	Outdoor
Adjustable	No
With light source	Yes

## Lifespan

Lifespan L70/B50 at 25 °C	100000 h <sup>1)</sup>
Lifespan L80/B10 at 25 °C	70000 h <sup>1)</sup>
Lifespan L80/B50 at 25 °C	70000 h
Lifespan L90/B10 at 25 °C	60000 h
Number of switching cycles	50000

<sup>1)</sup> t[h]: L70 / B50 @ 25 °C (Ta), t[h]: L80 / B10 @ 25 °C (Ta), t[h]: L90 / B10 @ 25 °C (Ta)

## Control gear







Output current	1100 mA
ECG - Output ripple current	< 15 %





## Certificates & Standards

Standards	CE / CB / EAC / ENEC
-----------	----------------------

Luminaire with limited surface temperature, "D sign"	No
Ball shot safe	No
Replaceable light source (EPREL)	Not replaceable

## DOWNLOAD DATA

Documents and certificates		Document name
	User instruction / safety instructions	DL SURFACE IP65
	Legal information	LSI DL SURFACE IP65
	Legal information	Legal Insert DL SURFACE
	Legal information	Informationstext 18 Abs 4 ElektroG
	Declarations of conformity	CE Declaration of Conformity DL SURFACE IP65
	Declarations of conformity UKCA	UKCA Declaration of Conformity DL SURFACE IP65
	Certificates	DL SF IP65

Photometric and lighting design files		Document name
	IES file (IES)	DL SURFACE DN250P 45W 830 60D IP65 WT
	LDT file (Eulumdat)	DL SURFACE DN250P 45W 830 60D IP65 WT
	UGR file (UGR table)	DL SURFACE DN250P 45W 60D IP65
	Light distribution curve type cone	DL SURFACE DN250P 45W 60D IP65
	Light distribution curve type polar	DL SURFACE 60D IP65

Tender texts		Document name
	Tender documents	DOWNLIGHT SURFACE IP65 DN 250 P 45W 830 60D WT-en

LOGISTICAL DATA

Product code	Packaging unit (Pieces/Unit)	Dimensions (length x width x height)	Gross weight	Volume
4058075769298	Folding box 1	297 mm x 297 mm x 172 mm	2900.00 g	15.17 dm <sup>3</sup>
4058075769304	Shipping box 4	616 mm x 316 mm x 366 mm	12600.00 g	71.24 dm <sup>3</sup>

The mentioned product code describes the smallest quantity unit which can be ordered. One shipping unit can contain one or more single products. When placing an order, for the quantity please enter single or multiples of a shipping unit.

ADDITIONAL CATALOG INFORMATION

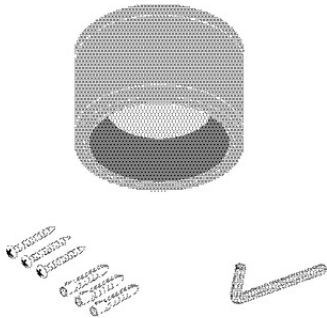

References / Links

– For Guarantee see [www.ledvance.com/guarantee](http://www.ledvance.com/guarantee)

DISCLAIMER

Subject to change without notice. Errors and omission excepted. Always make sure to use the most recent release.