

Description



These switches are used on machines where the hazardous conditions remain for a while, even after the machines have been switched off, for example because of mechanical inertia of pulleys, saw disks, parts under pressure or with high temperatures. Thus, the switches can also be used if individual guards are only to be opened under certain conditions.

The versions with solenoid actuated NC contacts are considered interlocks with locking in accordance with ISO 14119, and the product's label is marked with the symbol shown.



Technopolymer housing



The FY series safety switches have glass fibre reinforced housing made of reinforced technopolymer that is shock-proof, self-extinguishing and very resistant to the extraction force that can be exerted by the actuator.

The new design combines robustness and functionality with a modern aesthetic.

Integrated control devices

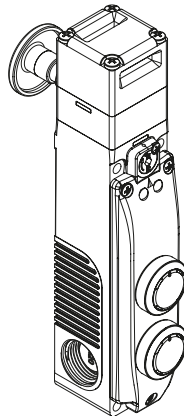

The switch is also available with integrated control devices, allowing up to two devices and related contact blocks, such as buttons, emergency stop buttons, indicator lights or selectors to be mounted.

The result is a compact solution with direct access to control devices without needing to install them separately on the switch panel or in their own housing.

The devices can be illuminated and, thanks to the PUSH-IN spring-operated connections, wiring is quick and intuitive.

Holding force of the locked actuator

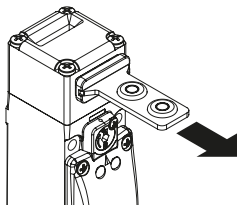

The strong interlocking system guarantees a maximum actuator holding force of $F_{1max} = 2800 \text{ N}$.

Key release with triangular key



The auxiliary key release is also available with option V73, a variant with triangular key acc. to DIN 22417. This option can be used with installations in which the auxiliary release is to be actuated with a triangular key that is not normally available.

On request, option V70 is also available, with which the auxiliary release returns to the initial position with the aid of a spring.

Heads and devices with variable orientation

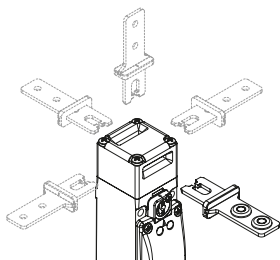

The system can be variably configured by loosening the 4 screws on the head.

The key release device and the release button can also be rotated and secured independently of one another in steps of 90° . The device can thus assume 32 different configurations.

Wide-ranging actuator travel

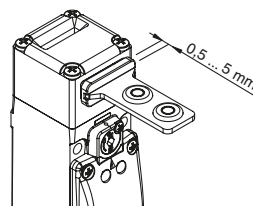

The actuation head of this switch features a wide range of travel. In this way the guard can oscillate along the direction of insertion (4.5 mm) without causing unwanted machine shutdowns. This wide range of travel is available in all actuators in order to ensure maximum device reliability.

Non-detachable heads and release devices

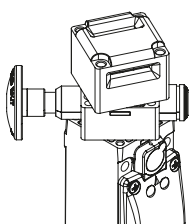

The head and the release device can be rotated but cannot be detached from each other. This makes the switch more secure since the problem of incorrect assembly by the installer cannot occur; in addition, the risk of damage is lower (loss of small parts, penetration of dirt, etc.).

Key release device and escape release button

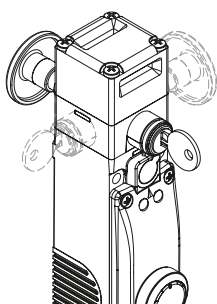

The key release device (auxiliary release) is used to permit unlocking of the actuator only by personnel in possession of the key. The device also functions with no power supply and, once actuated, prevents the guard from being locked.

The escape release button allows actuator release and immediate opening of the guard. Generally used in machines within which an operator could inadvertently become trapped, it faces towards the machine interior, to allow the operator to exit even in the event of

a power failure. The button has two stable states and can be freely extended in length with suitable extensions (see accessories).

Both devices can be positioned on the four sides of the switch. As a result, it can be installed both towards the interior and towards the exterior of the machine.

Contact blocks with 4 contacts

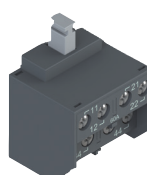

Innovative contact block with 4 contacts, available in various contact configurations for monitoring the actuator or the solenoid (patented). The unit is supplied with captive screws and self-lifting clamping plates. Removable finger protection for eyelet terminal.

High-reliability electrical contacts with 4 contact points and double interruption.

Safety screws for actuators

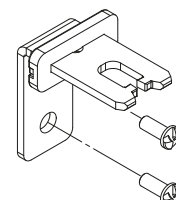

As required by EN ISO 14119, the actuator must be fixed immovably to the guard frame. Pan head safety screws with one-way fitting are available for this purpose. With this screw type, the actuators cannot be removed or tampered by using common tools. See accessories on page 419.



LED display unit, type A



In the version with LED display unit of type A, two green LEDs are switched-on directly by the power supply of the solenoid. Wiring is not necessary.

LED display unit, types B and C

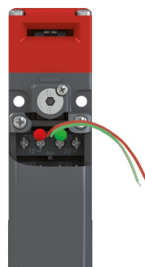

In the version with LED display unit of type B, connection wires from two LEDs are available, one green and one red. By means of suitable connections on the contact block, various operating states of the switch can be displayed externally.

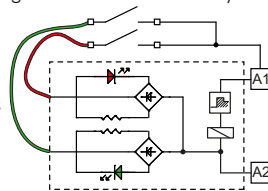

Protection degree IP67

IP67 These devices are designed to be used under the toughest environmental conditions, and they pass the IP67 immersion test acc. to EN 60529. They can therefore be used in all environments where the maximum degree of protection is required for the housing.

Three conduit entries

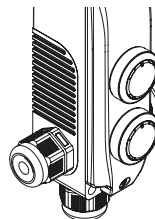

The switch is provided with three conduit entries in different directions. This allows its application in series connections or in narrow places.

Extended temperature range

-40°C These devices are also available in a special version suitable for an ambient operating temperature range from -40°C up to +60°C.

They can therefore be used for applications in cold stores, sterilisers, and other equipment operated in very low-temperature environments. The special materials used to produce these versions retain their characteristics even under these conditions, thereby expanding the installation possibilities.

Sealable auxiliary release device



Switches with locked actuator with deactivated solenoid (function principle D) are equipped with an auxiliary release device for the solenoid to simplify installation of the switch and to facilitate entry into the danger zone in the event of a power failure. The auxiliary release device acts on the switch exactly as if the solenoid was energised. As a result, it also actuates the electrical contacts. Can only be actuated with the use of two tools; this ensures adequate protection against tampering. If necessary, it can be sealed using the appropriate hole.

Laser engraving



All FY series switches are permanently marked with a special laser system. As a result, the marking remains legible even under extreme operating conditions. Thanks to this system that does not use labels, the loss of plate data is prevented and a greater resistance of the marking is achieved over time.

In the versions with buttons on the cover, the button lenses can be laser-engraved on request so that the desired texts are directly and permanently applied to the lenses.

Access monitoring

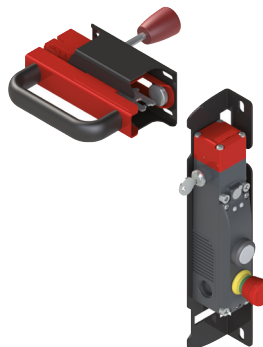

These safety switches alone do not provide sufficient personal protection to the operators or maintenance personnel in situations where they completely enter the danger zone, since unintentional closing of a door after entry could cause the machine to re-start. If the re-start release is completely dependent on these switches, a system for preventing this danger must be provided, e.g. a padlockable device for actuator entry locking VF KB2 (page 154) or a safety handle, such as P-KUBE Fast (page 221).

Holding force of the unlocked actuator

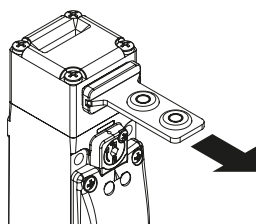

The inside of each switch features a device which holds the actuator in its closed position. Ideal for all those applications where several guards are unlocked simultaneously, but only one is actually opened. The device keeps all the unlocked guards in their position with a retaining force of approx. 30 N, stopping any vibrations or gusts of wind from opening them.

LED signalling lights



Thanks to the three threaded cable entries, the high luminosity LED signalling lights of the VF SL series can be installed on the switch.

The LED signalling lights can be easily installed by screwing them on one of the conduit entries not used for electric cables. They can be used for many different purposes: for example, to signal, from a distance, whether the switch has been actuated; whether the guard has closed correctly; or whether the guard is locked or unlocked.

For more information see chapter Accessories, page 419.

Selection diagram

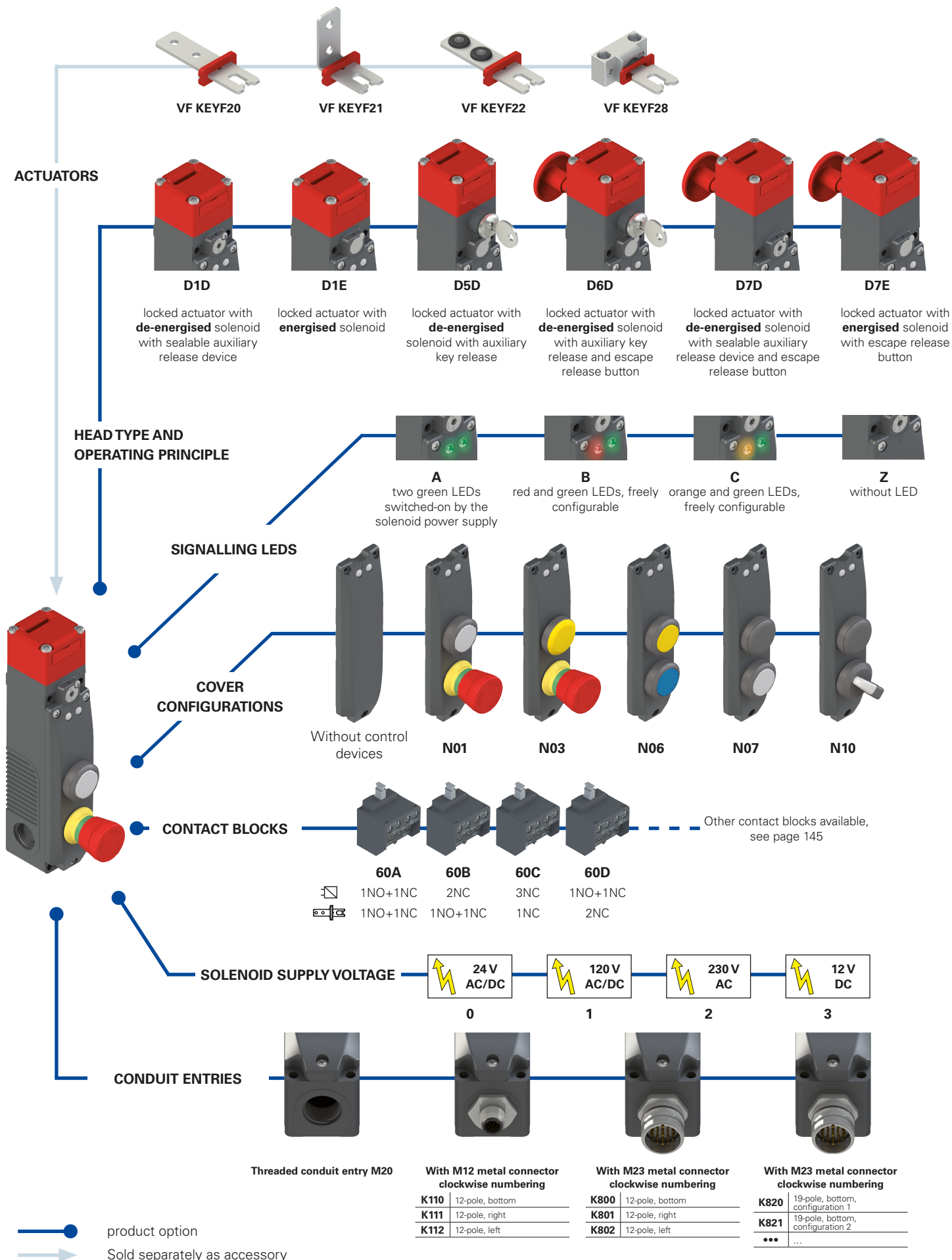



Code structure

Attention! The feasibility of a code number does not mean the effective availability of a product. Please contact our sales office.

article options

FY 60AD1D0A-LP30N01F20GK110T6V34

Contact blocks		
	Contacts activated by the solenoid	Contacts activated by the actuator
60A	1NO+1NC	1NO+1NC
60B	2NC	1NO+1NC
60C	3NC	1NC
60D	1NO+1NC	2NC
60E	1NO+2NC	1NC
60F	1NO+2NC	1NO
60G	2NC	2NC
60H	4NC	/
60I	3NC	1NO
60L	2NO+1NC	1NC
60M	2NO+1NC	1NO
60N	1NO+1NC	2NO
60P	1NC	3NC
60R	2NO+2NC	/
60S	1NC	2NO+1NC
60T	1NC	1NO+2NC
60U	/	4NC
60V	2NC	2NO
60X	1NO	3NC
60Y	1NO	1NO+2NC
61A	/	1NO+3NC
61B	/	2NO+2NC
61C	/	3NO+1NC
61D	1NC	3NO
61E	1NO	2NO+1NC
61G	2NO	1NO+1NC
61H	2NO	2NC
61M	3NO	1NC
61R	1NO+3NC	/
61S	3NO+1NC	/

Note: contact blocks 60U, 61A, 61B, 61C cannot be combined with operating principles D6D, D7D, D7E.

Operating principle	
D1D	locked actuator with de-energised solenoid. With sealable auxiliary release device.
D1E	locked actuator with energised solenoid
D5D	locked actuator with de-energised solenoid. With auxiliary key release.
D6D	locked actuator with de-energised solenoid. With auxiliary key release and escape release button.
D7D	locked actuator with de-energised solenoid. With sealable auxiliary release device and escape release button.
D7E	locked actuator with energised solenoid. With escape release button.

Auxiliary release options

(only for articles FY ***D5D**, FY ***D6D**)

The key can be removed in locked and unlocked actuator position (standard)

V34 The key can be removed only in the locked position of the actuator

V70 Key release with triangular key with spring return (description on page 151)

V73 Key release with triangular key, no spring return (description on page 151)

Ambient temperature

-25°C ... +60°C (standard)

T6 -40°C ... +60°C

Pre-installed connectors

without connector (standard)

K110 M12 metal connector, 12-pole, bottom

K800 M23 metal connector, 12-pole, bottom

K820 M23 metal connector, 19-pole, bottom, configuration 1

... ..

For the complete list of possible combinations please contact our technical department.
Note: The 19-pole M23 connector is only available for versions with integrated control devices and 24 Vdc supply voltage.

Contact type

silver contacts (standard)

G silver contacts with 1 µm gold coating

Actuators

without actuator (standard)

F20 straight actuator VF KEYF20

F21 angled actuator VF KEYF21

F22 actuator with rubber pads VF KEYF22

F28 universal actuator VF KEYF28

Button configurations

N01 configuration 01

N02 configuration 02

N03 configuration 03

... other configurations on request

Release button length

for max. 15 mm wall thickness (standard)

LP30 for max. 30 mm wall thickness

LP40 for max. 40 mm wall thickness

LP60 for max. 60 mm wall thickness

LPRG adjustable, for wall thickness from 60 mm to 500 mm

Signalling LEDs

A two green LEDs switched-on by the solenoid power supply

B red and green LEDs, freely configurable

C orange and green LEDs, freely configurable

Z without LED

Solenoid supply voltage

0 24 Vac/dc (-10% ... +10%)

1 120 Vac/dc (-15% ... +10%)

2 230 Vac (-15% ... +10%)

3 12 Vdc (-10% ... +10%)



Main features

- Actuator holding force F_{1max} : 2800 N
- 30 contact blocks with 4 contacts
- Technopolymer housing, three M20 conduit entries
- Protection degrees IP67 and IP69K
- Versions with key release and escape release button
- Versions with integrated control devices
- 4 stainless steel actuators
- Head and release devices, individually turnable and non-detachable
- Signalling LEDs
- Operation with energised or de-energised solenoid

Quality marks:



IMQ approval: CA02.03808
 UL approval: E131787
 CCC approval: 2021000305000103

Technical data

Housing

Housing made of glass fibre reinforced technopolymer, self-extinguishing and shock-proof
 Head and release device both made of metal, powder-coated and fired in a kiln
 Three knock-out threaded conduit entries: M20x1.5 (standard)
 Protection degree: IP67 acc. to EN 60529 (with cable gland of equal or higher protection degree)
 IP69K acc. to ISO 20653 (Protect the cables from direct high-pressure and high-temperature jets)

Protection degree with control devices: IP65 acc. to EN 60529

General data

"Maximum SIL" (SIL CL) up to: SIL 3 acc. to EN IEC 62061
 Performance Level (PL) up to: PL e acc. to EN ISO 13849-1
 Interlock with mechanical lock, coded: type 2 acc. to EN ISO 14119
 Coding level: low acc. to EN ISO 14119
 Safety parameters:
 B_{10D} : 5,000,000 for NC contacts
 Mission time: 20 years
 Ambient temperature: -25°C ... +60°C (standard)
 -40°C ... +60°C (T6 option)
 Max. actuation frequency: 600 operating cycles/hour
 Mechanical endurance: 1 million operating cycles
 Max. actuation speed: 0.5 m/s
 Min. actuation speed: 1 mm/s
 Maximum force before breakage F_{1max} : 2800 N acc. to EN ISO 14119
 Max. holding force F_{Zh} : 2150 N acc. to EN ISO 14119
 Maximum clearance of locked actuator: 4.5 mm
 Released actuator extraction force: 30 N
 Tightening torques for installation: see page 441
 Wire cross-sections and wire stripping lengths: see page 464

Solenoid

Duty cycle: 100% ED (continuous operation)
 Solenoid consumption: 9 VA

In compliance with standards:

EN 60947-5-1, EN 60947-1, EN 60204-1, EN ISO 14119, EN ISO 12100, EN 60529, EN 61000-6-2, EN 61000-6-3, EN IEC 63000, BG-GS-ET-15, BG-GS-ET-19, UL 508, CSA C22.2 No. 14.

Approvals:

EN 60947-5-1, UL 508, CSA C22.2 No. 14, GB/T14048.5

Compliance with the requirements of:

Machinery Directive 2006/42/EC, EMC Directive 2014/30/EU, RoHS Directive 2011/65/EU.

Positive contact opening in conformity with standards:

IEC 60947-5-1, EN 60947-5-1.

⚠ If not expressly indicated in this chapter, for correct installation and utilization of all articles see the instructions given on pages 443 to 454.

	Electrical data of the contact block of the switch	Utilization category
without connector	Thermal current (I_{th}): 6 A Rated insulation voltage (U_i): 400 Vac 300 Vdc Rated impulse withstand voltage (U_{imp}): 6 kV Conditional short circuit current: 1000 A acc. to EN 60947-5-1 Protection against short circuits: type gG fuse 10 A 500 V Pollution degree: 3	Alternating current: AC15 (50÷60 Hz) U_e (V) 120 250 400 I_e (A) 6 5 3 Direct current: DC13 U_e (V) 24 125 250 I_e (A) 3 0.7 0.4
with M23 connector, 12-pole	Thermal current (I_{th}): 6 A Rated insulation voltage (U_i): 250 Vac 300 Vdc Protection against short circuits: type gG fuse 8 A 500 V Pollution degree: 3	Alternating current: AC15 (50÷60 Hz) U_e (V) 120 250 I_e (A) 6 5 Direct current: DC13 U_e (V) 24 125 250 I_e (A) 3 0.7 0.4
with M23 connector, 19-pole	Thermal current (I_{th}): 3 A Rated insulation voltage (U_i): 30 Vac 36 Vdc Protection against short circuits: type gG fuse 1 A Pollution degree: 3	Alternating current: AC15 (50÷60 Hz) U_e (V) 24 I_e (A) 3 Direct current: DC13 U_e (V) 24 I_e (A) 3
with M12 connector, 12-pole	Thermal current (I_{th}): 1.5 A Rated insulation voltage (U_i): 30 Vac 36 Vdc Protection against short circuits: type gG fuse 1.5 A Pollution degree: 3	Alternating current: AC15 (50÷60 Hz) U_e (V) 24 I_e (A) 1.5 Direct current: DC13 U_e (V) 24 I_e (A) 1.5



Features approved by IMQ

Rated insulation voltage (U _i):	400 Vac
Conventional free air thermal current (I _m):	6 A
Protection against short circuits:	type gG fuse 6 A 500 V
Rated impulse withstand voltage (U _{imp}):	6 kV
Protection degree of the housing:	IP67/IP69K (without auxiliary buttons) IP65 (with auxiliary buttons)
MV terminals (screw terminals)	
Pollution degree:	3
Utilization category:	AC15
Operating voltage (U _e):	400 Vac (50 Hz)
Operating current (I _e):	3 A

Forms of the contact element: X+Y+X+Y, Y+Y+X+Y, Y+Y+Y+Y, X+Y+Y+Y, X+Y+Y+X, Y+Y+Y+X, X+X+Y+Y, X+X+Y+X, X+Y+X+X, Y+Y+X+X, X+X+X+X, Y+X+X+X, X+X+X+Y.

Positive opening of contacts on all contact blocks: 60A, 60B, 60C, 60D, 60E, 60F, 60G, 60H, 60I, 60L, 60M, 60N, 60P, 60R, 60S, 60T, 60U, 60V, 60X, 60Y, 61A, 61B, 61C, 61D, 61E, 61G, 61H, 61M, 61R, 61S.

In compliance with standards: EN 60947-1, EN 60947-5-1, fundamental requirements of the Low Voltage Directive 2014/35/EU.

Please contact our technical department for the list of approved products.

Features approved by UL

Electrical Ratings:
Main ratings:
Input with coil 12 Vdc, 24 Vac/dc, 120 Vac/dc, 230Vac
Output Pilot Duty B300, Q300
Overvoltage category II

Secondary ratings:
Output 24 Vac/dc "Class 2" 0.25 A Pilot Duty (Maximum two Actuators, with maximum five contacts, NO or NC or both)

Environmental Ratings:
Enclosure type 1, 4X, 12, 13 for model FY 6xxxxxxx-xxx
Enclosure type 1 for model FY 6xxxxxxx-Nxx

The hub is to be connected to the conduit before the hub is connected to the enclosure.
Value of tightening torque of cover's screws 1.0-1.2 Nm.



Operating principle

The operating principle of these safety switches allows three different operating states:

state A: with inserted and locked actuator

state B: with inserted but not locked actuator

state C: with extracted actuator

All or some of these states can be monitored by means of electrical NO contacts or NC contacts with positive opening by selecting the appropriate contact blocks. In detail, contact blocks that have electric contacts marked with the symbol of the solenoid () are switched in the transition between the state A and state B, while the electric contacts marked with the symbol of the actuator () are switched between state B and state C.

Operating principle

Select from two operating principles for actuator locking:

- **Operating principle D**: locked actuator with de-energised solenoid. The actuator is released by applying the power supply to the solenoid (see example of the operating phases).
- **Operating principle E**: locked actuator with energised solenoid. The actuator is released by switching off the power supply to the solenoid. This version should only be used under certain conditions, since a power failure at the system will result in the immediate opening of the guard.



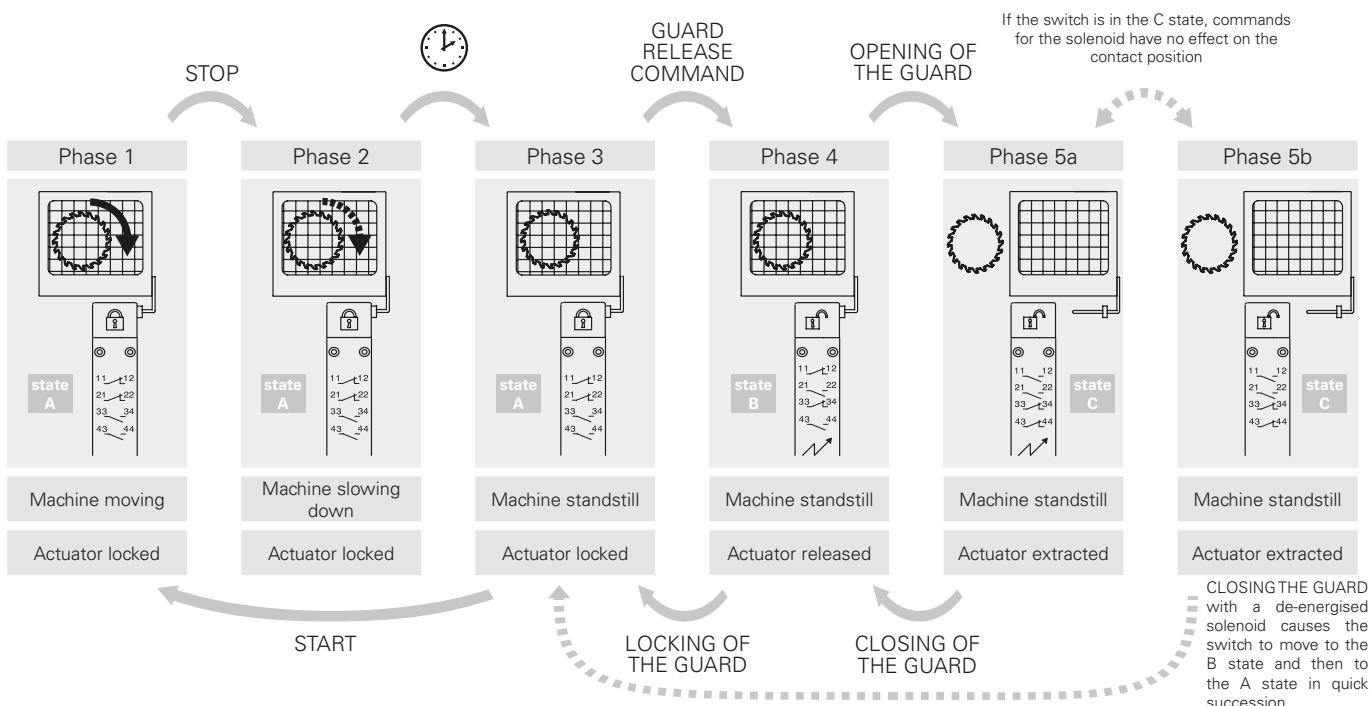





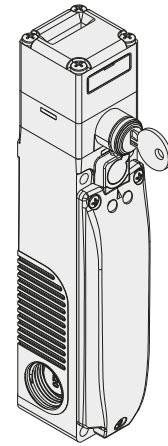
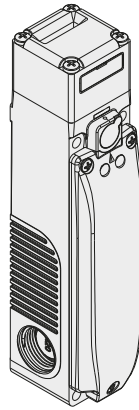
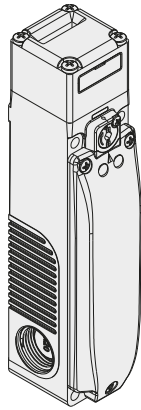

















































































































































































Example: operating phases with FY 60AD1D0A-F21 (switch with operating principle D)



Selection table for switches

Contact type
 = slow action



Operating principle	Operating principle D, with sealable auxiliary release device, without actuator	Operating principle E, without actuator	Operating principle D, with key release, without actuator
Contact block	 	 	 
60A	 FY 60AD1D0A   1NO+1NC 1NO+1NC	FY 60AD1E0A   1NO+1NC 1NO+1NC	FY 60AD5D0A   1NO+1NC 1NO+1NC
60B	 FY 60BD1D0A   2NC 1NO+1NC	FY 60BD1E0A   2NC 1NO+1NC	FY 60BD5D0A   2NC 1NO+1NC
60C	 FY 60CD1D0A   3NC 1NC	FY 60CD1E0A   3NC 1NC	FY 60CD5D0A   3NC 1NC
60D	 FY 60DD1D0A   1NO+1NC 2NC	FY 60DD1E0A   1NO+1NC 2NC	FY 60DD5D0A   1NO+1NC 2NC
60E	 FY 60ED1D0A   1NO+2NC 1NC	FY 60ED1E0A   1NO+2NC 1NC	FY 60ED5D0A   1NO+2NC 1NC
60F	 FY 60FD1D0A   1NO+2NC 1NO	FY 60FD1E0A   1NO+2NC 1NO	FY 60FD5D0A   1NO+2NC 1NO
60G	 FY 60GD1D0A   2NC 2NC	FY 60GD1E0A   2NC 2NC	FY 60GD5D0A   2NC 2NC
60H	 FY 60HD1D0A   4NC /	FY 60HD1E0A   4NC /	FY 60HD5D0A   4NC /
60I	 FY 60ID1D0A   3NC 1NO	FY 60ID1E0A   3NC 1NO	FY 60ID5D0A   3NC 1NO
60L	 FY 60LD1D0A   2NO+1NC 1NC	FY 60LD1E0A   2NO+1NC 1NC	FY 60LD5D0A   2NO+1NC 1NC
60M	 FY 60MD1D0A   2NO+1NC 1NO	FY 60MD1E0A   2NO+1NC 1NO	FY 60MD5D0A   2NO+1NC 1NO
60N	 FY 60ND1D0A   1NO+1NC 2NO	FY 60ND1E0A   1NO+1NC 2NO	FY 60ND5D0A   1NO+1NC 2NO
60P	 FY 60PD1D0A   1NC 3NC	FY 60PD1E0A   1NC 3NC	FY 60PD5D0A   1NC 3NC
60R	 FY 60RD1D0A   2NO+2NC /	FY 60RD1E0A   2NO+2NC /	FY 60RD5D0A   2NO+2NC /
60S	 FY 60SD1D0A   1NC 2NO+1NC	FY 60SD1E0A   1NC 2NO+1NC	FY 60SD5D0A   1NC 2NO+1NC
60T	 FY 60TD1D0A   1NC 1NO+2NC	FY 60TD1E0A   1NC 1NO+2NC	FY 60TD5D0A   1NC 1NO+2NC
60U	 FY 60UD1D0A  / 4NC	FY 60UD1E0A  / 4NC	FY 60UD5D0A  / 4NC
60V	 FY 60VD1D0A   2NC 2NO	FY 60VD1E0A   2NC 2NO	FY 60VD5D0A   2NC 2NO
60X	 FY 60XD1D0A  1NO 3NC	FY 60XD1E0A  1NO 3NC	FY 60XD5D0A  1NO 3NC
60Y	 FY 60YD1D0A  1NO 1NO+2NC	FY 60YD1E0A  1NO 1NO+2NC	FY 60YD5D0A  1NO 1NO+2NC
61A	 FY 61AD1D0A  / 1NO+3NC	FY 61AD1E0A  / 1NO+3NC	FY 61AD5D0A  / 1NO+3NC
61B	 FY 61BD1D0A  / 2NO+2NC	FY 61BD1E0A  / 2NO+2NC	FY 61BD5D0A  / 2NO+2NC
61C	 FY 61CD1D0A  / 3NO+1NC	FY 61CD1E0A  / 3NO+1NC	FY 61CD5D0A  / 3NO+1NC
61D	 FY 61DD1D0A   1NC 3NO	FY 61DD1E0A   1NC 3NO	FY 61DD5D0A   1NC 3NO
61E	 FY 61ED1D0A  1NO 2NO+1NC	FY 61ED1E0A  1NO 2NO+1NC	FY 61ED5D0A  1NO 2NO+1NC
61G	 FY 61GD1D0A  2NO 1NO+1NC	FY 61GD1E0A  2NO 1NO+1NC	FY 61GD5D0A  2NO 1NO+1NC
61H	 FY 61HD1D0A  2NO 2NC	FY 61HD1E0A  2NO 2NC	FY 61HD5D0A  2NO 2NC
61M	 FY 61MD1D0A  3NO 1NC	FY 61MD1E0A  3NO 1NC	FY 61MD5D0A  3NO 1NC
61R	 FY 61RD1D0A   1NO+3NC /	FY 61RD1E0A   1NO+3NC /	FY 61RD5D0A   1NO+3NC /
61S	 FY 61SD1D0A   3NO+1NC /	FY 61SD1E0A   3NO+1NC /	FY 61SD5D0A   3NO+1NC /
Actuating force	30 N (60 N )		
Travel diagrams	Page 465		

Legend:  With positive opening according to EN 60947-5-1,  interlock with lock monitoring acc. to EN ISO 14119









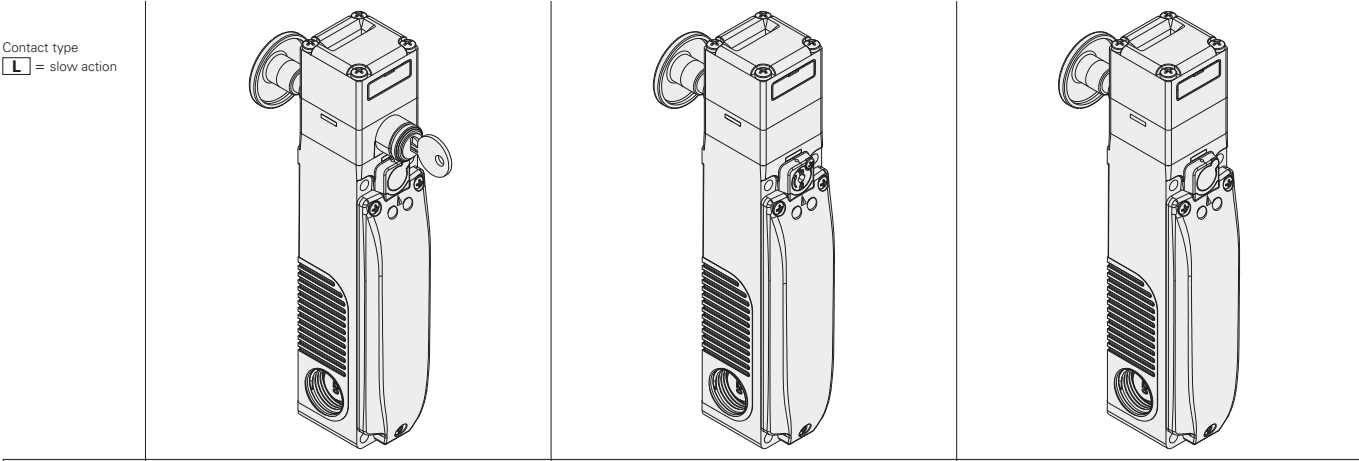







































































































































Note: The position of the contacts depending on the switch state can be found on pages 129-130 by replacing codes FG with FY.



Note: See pages 155-156 for the connection diagrams for M12 and M23 connector contact blocks.



Selection table for switches



Operating principle	Operating principle D, with key release, escape release button, without actuator	Operating principle D, with escape release button, without actuator	Operating principle E, with escape release button, without actuator
Contact type L = slow action			
Operating principle	Operating principle D, with key release, escape release button, without actuator	Operating principle D, with escape release button, without actuator	Operating principle E, with escape release button, without actuator
Contact block	 	 	 
60A L	FY 60AD6D0A   1NO+1NC 1NO+1NC	FY 60AD7D0A   1NO+1NC 1NO+1NC	FY 60AD7E0A   1NO+1NC 1NO+1NC
60B L	FY 60BD6D0A   2NC 1NO+1NC	FY 60BD7D0A   2NC 1NO+1NC	FY 60BD7E0A   2NC 1NO+1NC
60C L	FY 60CD6D0A   3NC 1NC	FY 60CD7D0A   3NC 1NC	FY 60CD7E0A   3NC 1NC
60D L	FY 60DD6D0A   1NO+1NC 2NC	FY 60DD7D0A   1NO+1NC 2NC	FY 60DD7E0A   1NO+1NC 2NC
60E L	FY 60ED6D0A   1NO+2NC 1NC	FY 60ED7D0A   1NO+2NC 1NC	FY 60ED7E0A   1NO+2NC 1NC
60F L	FY 60FD6D0A   1NO+2NC 1NO	FY 60FD7D0A   1NO+2NC 1NO	FY 60FD7E0A   1NO+2NC 1NO
60G L	FY 60GD6D0A   2NC 2NC	FY 60GD7D0A   2NC 2NC	FY 60GD7E0A   2NC 2NC
60H L	FY 60HD6D0A   4NC /	FY 60HD7D0A   4NC /	FY 60HD7E0A   4NC /
60I L	FY 60ID6D0A   3NC 1NO	FY 60ID7D0A   3NC 1NO	FY 60ID7E0A   3NC 1NO
60L L	FY 60LD6D0A   2NO+1NC 1NC	FY 60LD7D0A   2NO+1NC 1NC	FY 60LD7E0A   2NO+1NC 1NC
60M L	FY 60MD6D0A   2NO+1NC 1NO	FY 60MD7D0A   2NO+1NC 1NO	FY 60MD7E0A   2NO+1NC 1NO
60N L	FY 60ND6D0A   1NO+1NC 2NO	FY 60ND7D0A   1NO+1NC 2NO	FY 60ND7E0A   1NO+1NC 2NO
60P L	FY 60PD6D0A   1NC 3NC	FY 60PD7D0A   1NC 3NC	FY 60PD7E0A   1NC 3NC
60R L	FY 60RD6D0A   2NO+2NC /	FY 60RD7D0A   2NO+2NC /	FY 60RD7E0A   2NO+2NC /
60S L	FY 60SD6D0A   1NC 2NO+1NC	FY 60SD7D0A   1NC 2NO+1NC	FY 60SD7E0A   1NC 2NO+1NC
60T L	FY 60TD6D0A   1NC 1NO+2NC	FY 60TD7D0A   1NC 1NO+2NC	FY 60TD7E0A   1NC 1NO+2NC
60V L	FY 60VD6D0A   2NC 2NO	FY 60VD7D0A   2NC 2NO	FY 60VD7E0A   2NC 2NO
60X L	FY 60XD6D0A  1NO 3NC	FY 60XD7D0A  1NO 3NC	FY 60XD7E0A  1NO 3NC
60Y L	FY 60YD6D0A  1NO 1NO+2NC	FY 60YD7D0A  1NO 1NO+2NC	FY 60YD7E0A  1NO 1NO+2NC
61D L	FY 61DD6D0A   1NC 3NO	FY 61DD7D0A   1NC 3NO	FY 61DD7E0A   1NC 3NO
61E L	FY 61ED6D0A  1NO 2NO+1NC	FY 61ED7D0A  1NO 2NO+1NC	FY 61ED7E0A  1NO 2NO+1NC
61G L	FY 61GD6D0A  2NO 1NO+1NC	FY 61GD7D0A  2NO 1NO+1NC	FY 61GD7E0A  2NO 1NO+1NC
61H L	FY 61HD6D0A  2NO 2NC	FY 61HD7D0A  2NO 2NC	FY 61HD7E0A  2NO 2NC
61M L	FY 61MD6D0A  3NO 1NC	FY 61MD7D0A  3NO 1NC	FY 61MD7E0A  3NO 1NC
61R L	FY 61RD6D0A   1NO+3NC /	FY 61RD7D0A   1NO+3NC /	FY 61RD7E0A   1NO+3NC /
61S L	FY 61SD6D0A   3NO+1NC /	FY 61SD7D0A   3NO+1NC /	FY 61SD7E0A   3NO+1NC /
Actuating force	30 N (60 N )		
Travel diagrams	Page 465		

Legend:  With positive opening according to EN 60947-5-1,  interlock with lock monitoring acc. to EN ISO 14119

Note: The position of the contacts depending on the switch state can be found on pages 129-130 by replacing codes FG with FY.

Note: See pages 155-156 for the connection diagrams for M12 and M23 connector contact blocks.

Switch with integrated field-wireable control devices

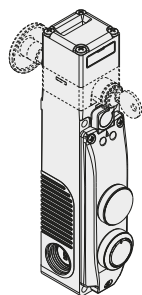

FY 6.....-N07			
	Description	Colour	Diagram
Device 1	Closing cap	black	/
Device 2	Illuminated button, spring-return 1NO	white	

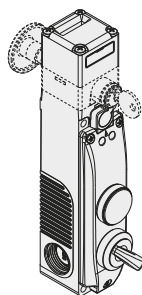

FY 6.....-N10			
	Description	Colour	Diagram
Device 1	Closing cap	black	/
Device 2	Selector switch 1NO with two fixed positions	black	

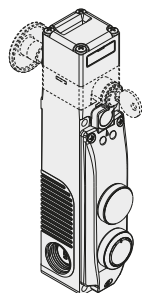

FY 6.....-N08			
	Description	Colour	Diagram
Device 1	Closing cap	black	/
Device 2	Illuminated button, spring-return 1NO	blue	

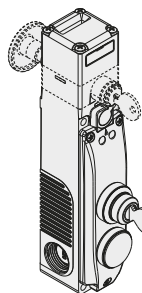

FY 6.....-N11			
	Description	Colour	Diagram
Device 1	Three-position key selector switch 2NO with return to centre	black	
Device 2	Closing cap	black	/

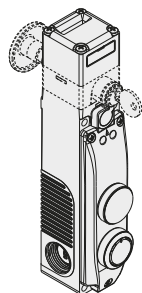

FY 6.....-N09			
	Description	Colour	Diagram
Device 1	Closing cap	black	/
Device 2	Spring-return button 1NO	black	

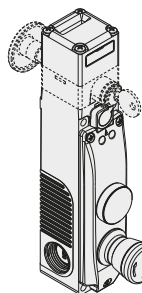

FY 6.....-N12			
	Description	Colour	Diagram
Device 1	Closing cap	black	/
Device 2	Emergency stop button with rotary release 2NC	red	

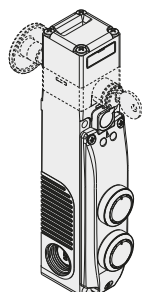

FY 6.....-N04			
	Description	Colour	Diagram
Device 1	Illuminated button, spring-return 1NO	white	
Device 2	Illuminated button, spring-return 1NO	blue	

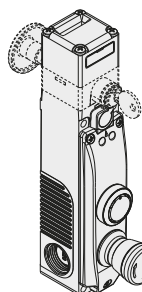

FY 6.....-N01			
	Description	Colour	Diagram
Device 1	Illuminated button, spring-return 1NO	white	
Device 2	Emergency stop button with rotary release 2NC	red	

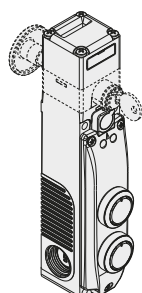

FY 6.....-N05			
	Description	Colour	Diagram
Device 1	Illuminated button, spring-return 1NO	white	
Device 2	Spring-return button 1NO	black	

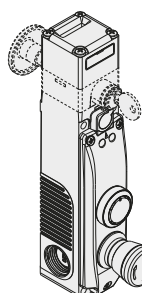

FY 6.....-N02			
	Description	Colour	Diagram
Device 1	Spring-return button 1NO	black	
Device 2	Emergency stop button with rotary release 2NC	red	

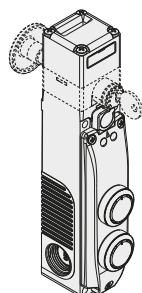

FY 6.....-N06			
	Description	Colour	Diagram
Device 1	Illuminated button, spring-return 1NO	yellow	
Device 2	Illuminated button, spring-return 1NO	blue	

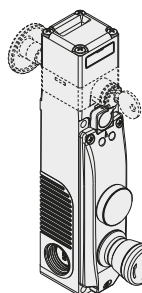

FY 6.....-N03			
	Description	Colour	Diagram
Device 1	Indicator light	yellow	
Device 2	Emergency stop button with rotary release 2NC	red	



Internal connections (version with integrated control devices to be connected)

Internal terminal strip for switch contact blocks

Internal terminal strip on the cover for integrated control devices

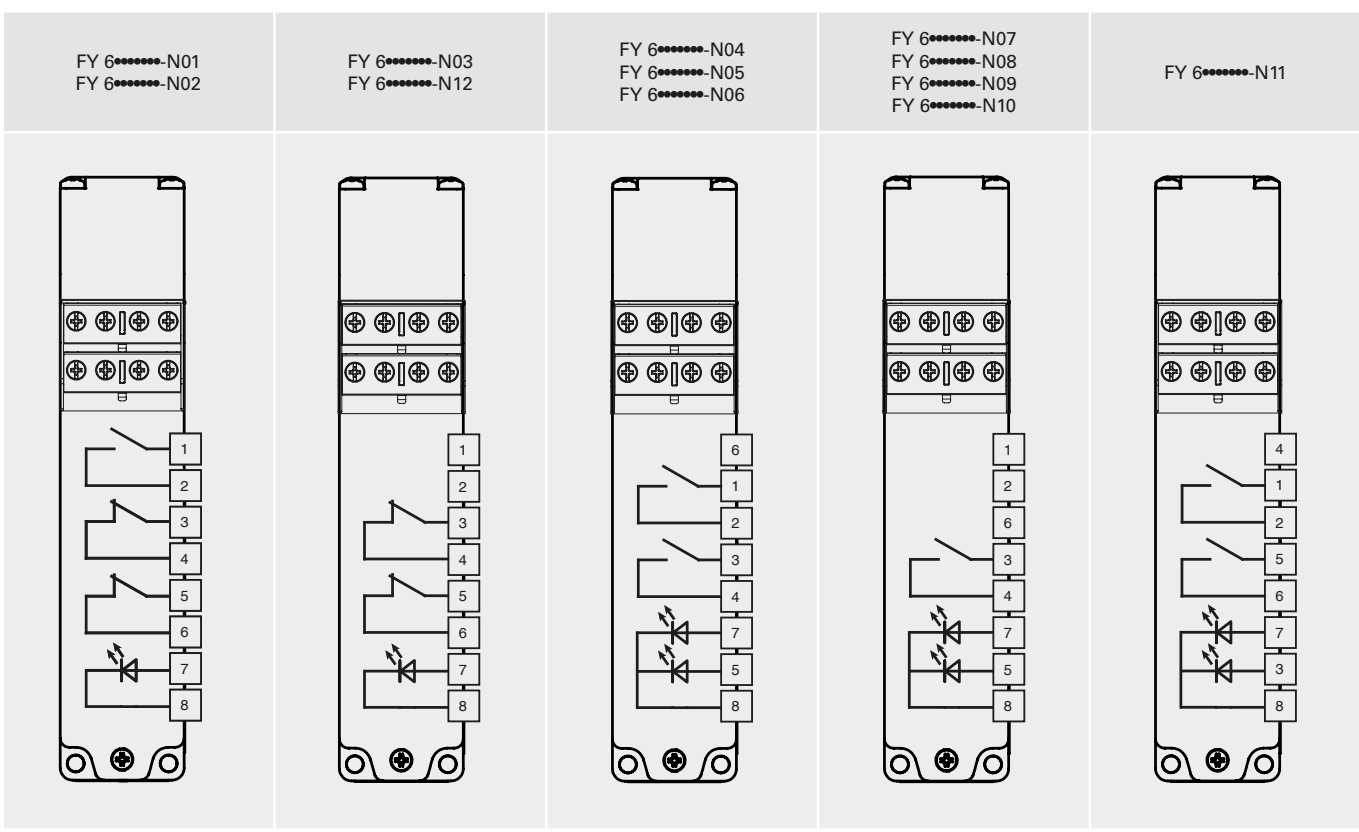
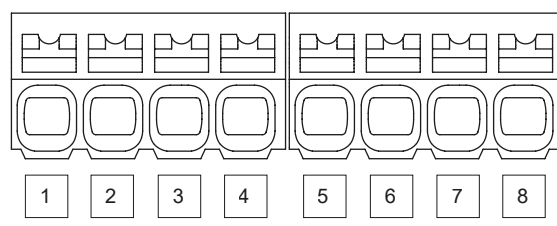
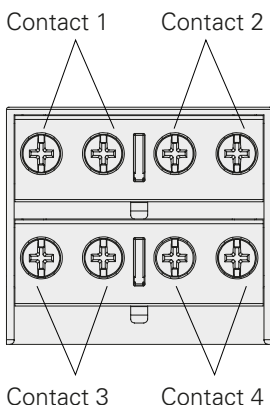

Note: The position of the contacts depending on the switch state can be found on pages 129-130 by replacing codes FG with FY.

Switch with integrated control devices and M23 connector, 19-pole

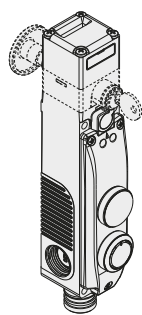

FY 600000-N07K823			
	Description	Colour	Diagram
Device 1	Closing cap	black	/
Device 2	Illuminated button, spring-return 1NO	white	

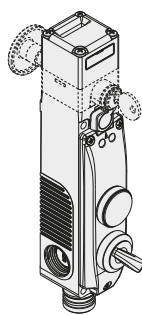

FY 600000-N10K823			
	Description	Colour	Diagram
Device 1	Closing cap	black	/
Device 2	Selector switch 1NO with two fixed positions	black	

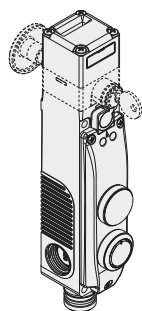

FY 600000-N08K823			
	Description	Colour	Diagram
Device 1	Closing cap	black	/
Device 2	Illuminated button, spring-return 1NO	blue	

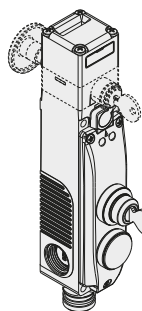

FY 600000-N11K824			
	Description	Colour	Diagram
Device 1	Three-position key selector switch 2NO with return to centre	black	
Device 2	Closing cap	black	/

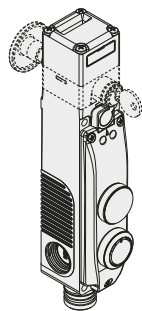

FY 600000-N09K823			
	Description	Colour	Diagram
Device 1	Closing cap	black	/
Device 2	Spring-return button 1NO	black	

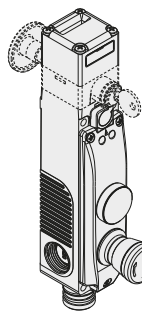

FY 600000-N12K821			
	Description	Colour	Diagram
Device 1	Closing cap	black	/
Device 2	Emergency stop button with rotary release 2NC	red	

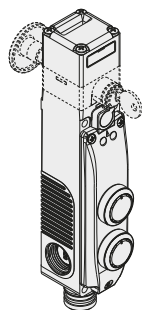

FY 600000-N04K822			
	Description	Colour	Diagram
Device 1	Illuminated button, spring-return 1NO	white	
Device 2	Illuminated button, spring-return 1NO	blue	

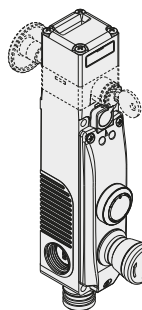

FY 600000-N01K820			
	Description	Colour	Diagram
Device 1	Illuminated button, spring-return 1NO	white	
Device 2	Emergency stop button with rotary release 2NC	red	

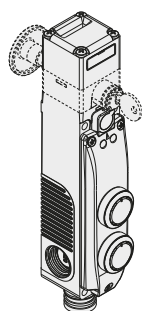

FY 600000-N05K822			
	Description	Colour	Diagram
Device 1	Illuminated button, spring-return 1NO	white	
Device 2	Spring-return button 1NO	black	

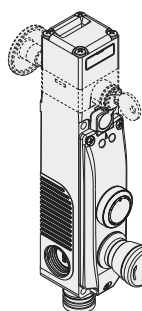

FY 600000-N02K820			
	Description	Colour	Diagram
Device 1	Spring-return button 1NO	black	
Device 2	Emergency stop button with rotary release 2NC	red	

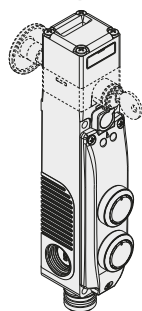

FY 600000-N06K822			
	Description	Colour	Diagram
Device 1	Illuminated button, spring-return 1NO	yellow	
Device 2	Illuminated button, spring-return 1NO	blue	

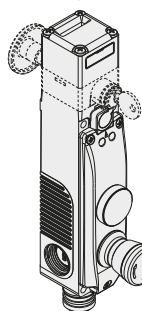

FY 600000-N03K821			
	Description	Colour	Diagram
Device 1	Indicator light	yellow	
Device 2	Emergency stop button with rotary release 2NC	red	



Internal connections (version with integrated control devices)

M23 connector, 19-pole

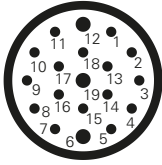

To connect the switch contact block to the 19-pole M23 connector, see pin numbers 1 to 10 of the diagrams on page 156.

FY 6*****-N01K820 FY 6*****-N02K820	FY 6*****-N03K821 FY 6*****-N12K821	FY 6*****-N04K822 FY 6*****-N05K822 FY 6*****-N06K822	FY 6*****-N07K823 FY 6*****-N08K823 FY 6*****-N09K823 FY 6*****-N10K823	FY 6*****-N11K824

Stainless steel actuators

IMPORTANT: These actuators can be used only with items of the FG and FY series (e.g. FY 60AD1D0A-F20).
Low level of coding acc. to EN ISO 14119.

	Article	Description
	VF KEYF20	Straight actuator

	Article	Description
	VF KEYF21	Angled actuator

	Article	Description
	VF KEYF22	Actuator with rubber pads

Universal actuator VF KEYF28

IMPORTANT: These actuators can be used only with items of the FG and FY series (e.g. FY 60AD1D0A-F28).
Low level of coding acc. to EN ISO 14119.

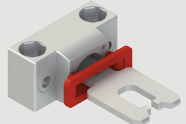
	Article	Description
	VF KEYF28	Universal actuator

Jointed actuator for guards with poor alignment, adjustable in two dimensions for small doors; can be mounted in various positions. The metal fixing body has two pairs of bore holes; it is provided for rotating the working plane of the actuator by 90°.

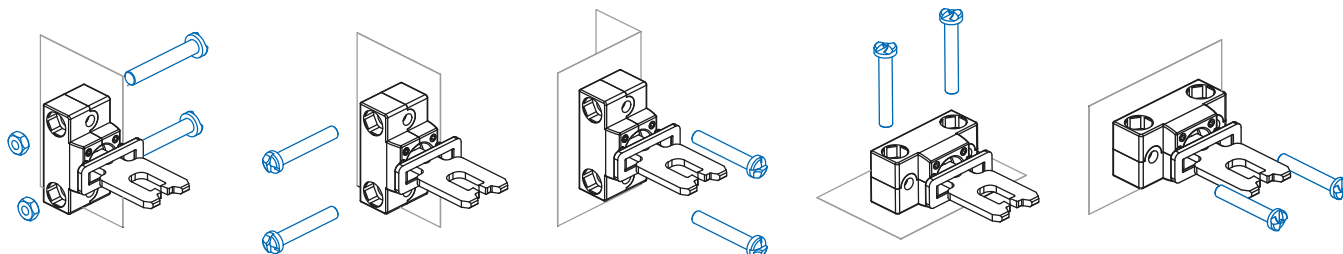
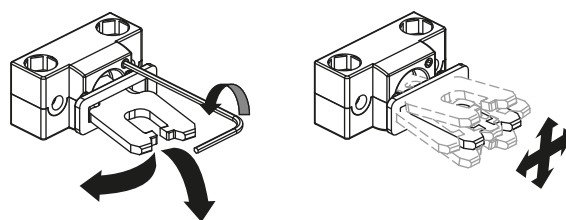
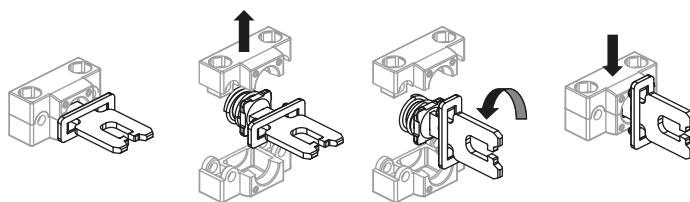

Auxiliary key release with triangular key









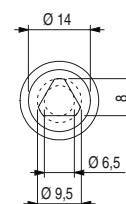











Articles with the V70 and V73 option have an auxiliary key release with a triangular key that meets DIN 22417 standards.



This type of lock can be used in situations where the switch must only be unlocked using the corresponding triangular key, a tool which is not usually available.

There are two versions of the triangular key release: with a spring return (option V70) and without a spring return (option V73).



Available control devices

	Description	Colour	Spare part number	Combinable with contacts ⁽¹⁾	Protrusion (x) mm
	Illuminated button, spring-return	<ul style="list-style-type: none"> ● White ● Red ● Green ● Yellow ● Blue 	VN NG-AC27121 VN NG-AC27123 VN NG-AC27124 VN NG-AC27125 VN NG-AC27126	1NO (1NC) (2NO) (1NO+1NC)	3
	Non-illuminated button, spring-return	● Black	VN NG-AC27122	1NO (1NC) (2NO) (1NO+1NC)	3
	Non-laser-markable, illuminated, projecting spring-return push button	● Red	VN NG-AC26018	1NO (1NC) (2NO) (1NO+1NC)	6,1
	Indicator light	<ul style="list-style-type: none"> ● Red ● Yellow ● Green ● Blue ● White 	VN NG-AC26060 VN NG-AC26061 VN NG-AC26062 VN NG-AC26063 VN NG-AC26064	/	2,7
	Emergency stop button acc. to EN ISO 13850				
	Rotary release Push-pull release	<ul style="list-style-type: none"> ● Red ● Red 	VN NG-AC26052 VN NG-AC26055	2NC	26,4
	Emergency stop button acc. to EN ISO 13850 for 2NC + 1NO contacts, spring-return ⁽²⁾				
	Rotary release	● Red	VN NG-AC26056	2NC + 1NO, spring-return	26,4
	Illuminated emergency stop button acc. to EN ISO 13850				
	Rotary release Push-pull release	<ul style="list-style-type: none"> ● Red ● Red 	VN NG-AC26051 VN NG-AC26054	2NC	26,4
	Simple stop button				
	Rotary release Push-pull release	<ul style="list-style-type: none"> ● Black ● Black 	VN NG-AC26053 VN NG-AC26057	2NC	26,4
	Illuminated selector switch with handle, with transparent lens for LED				
	<ul style="list-style-type: none"> ∨ ▷ ∨ ∨ 	<ul style="list-style-type: none"> ● Black ● Black ● Black ● Black 	VN NG-AC26033 VN NG-AC26030 VN NG-AC26034 VN NG-AC26031	1NO (1NC) (2NO) (1NO+1NC)	16,8
	Key selector switch, 2 positions				
	<ul style="list-style-type: none"> ∨ ▷ ∨ 	<ul style="list-style-type: none"> ● Black ● Black ● Black 	VN NG-AC26043 VN NG-AC26040 VN NG-AC26041	1NO (1NC) (2NO) (1NO+1NC)	39 (a) 14 (b)
	Closing cap	● Black	VN NG-AC26020	/	2,7
	Fixing key	● Black	VN NG-AC26080	/	/

Legend:  Maintained  Spring-return  Key extraction position (a) with key (b) without key

⁽¹⁾ The contacts in brackets are on request. Contact our technical department to verify the effective feasibility of the control device unit with the chosen combination of control devices.

⁽²⁾ The NO contact with spring-return is only activated if the emergency stop button reaches the stop. The signal of the NO contact is captured by analysing the rising edge.

To order buttons with marking:

add the marking code indicated in the tables on pp. 165-168 to the article codes of the General Catalogue HMI 2023-2024.

Example: Black spring-return button with "O" engraving.

VN NG-AC27122 → VN NG-AC27122-L1



Technical data of the control devices

General data

Protection degree:	IP65 acc. to EN 60529	
Mechanical endurance:		
Spring-return button:	1 million operating cycles	
Emergency stop button:	50,000 operating cycles	
Selector switch:	300,000 operating cycles	
Key selector switch:	50,000 operating cycles	
	30,000 operating cycles including removal of the key	
Safety parameter B_{10D} :	100,000 (emergency stop button)	

Actuating force

Spring-return button:	4 N min	100 N max.
Emergency stop button:	20 N min	100 N max.
Selector switch:	0.1 Nm min	1.5 Nm max.
Key selector switch:	0.1 Nm min	1.3 Nm max.

Contact blocks of the control devices

Material of the contacts:	silver contacts
Contact type:	Self-cleaning contacts with double interruption

Electrical data:

Thermal current I_{th} :	1 A
Rated insulation voltage U_i :	32 Vac/dc
Rated impulse withstand voltage U_{imp} :	1.5 kV
LED supply voltage:	24 Vdc \pm 15%
LED supply current:	10 mA per LED

Utilization category of the contact block:

Direct current: DC13
U_e (V) 24
I_e (A) 0.55

Signalling contact with spring return:

Direct current: DC13
U_e (V) 24
I_e (mA) 10

In compliance with standards:

IEC 60947-5-1, IEC 60947-5-5, EN ISO 13850

⚠ Installation for safety applications:

Always connect the safety circuit to the **NC contacts** (normally closed contacts) as stated in standard EN 60947-5-1.

Accessories

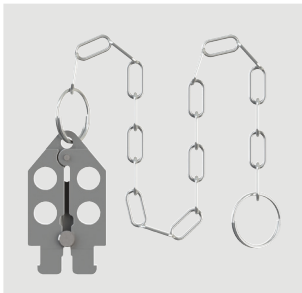
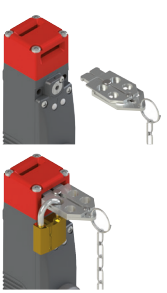
Article	Description
VF KB2	Lock out device
	Padlockable lock out device to prevent the actuator entry and the accidental closing of the door behind operators while they are in the danger area. To be used only with FG and FY series switches (e.g. FY 60AD1D0A). Hole diameter for padlocks: 9 mm.
	

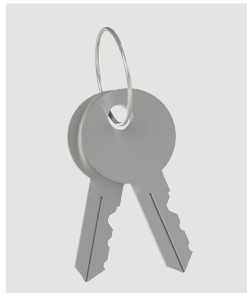
Article	Description
VF KLA371	Set of two locking keys
	Extra copy of the locking keys to be purchased if further keys are needed (standard supply: 2 units). The keys of all switches have the same code. Other codes on request.

Release button



Article	Description
VF FG-LP15	Technopolymer release button for max. 15 mm wall thickness, supplied with screw
VF FG-LP30	Technopolymer release button for max. 30 mm wall thickness, supplied with screw
VF FG-LP40	Technopolymer release button for max. 40 mm wall thickness, supplied with screw
VF FG-LP60	Metal release button for max. 60 mm wall thickness, supplied with screw

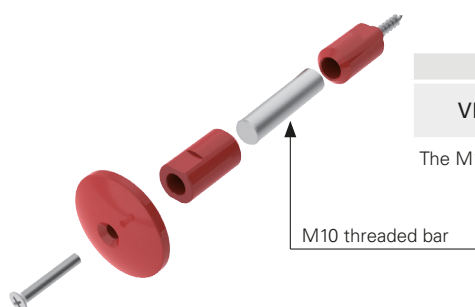

Article	Description
VF FG-LPRG	Metal release button for wall thickness from 60 to 500 mm, supplied with 2 supports and 2 screws, without M10 threaded bar

The M10 bar can be supplied in zinc-plated steel with 1 m length. Article: AC 8512.

Wiring diagram for M12 connectors

M12 connector, 12-pole

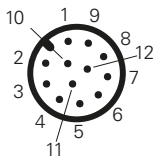

Contact block 60A 2NO+2NC		Contact block 60B 1NO+3NC		Contact block 60C 4NC		Contact block 60D 1NO+3NC		Contact block 60E 1NO+3NC		Contact block 60F 2NO+2NC		Contact block 60G 4NC		Contact block 60H 4NC		Contact block 60I 1NO+3NC		Contact block 60L 2NO+2NC					
Contacts	Pin no.	Contacts	Pin no.	Contacts	Pin no.	Contacts	Pin no.	Contacts	Pin no.	Contacts	Pin no.	Contacts	Pin no.	Contacts	Pin no.	Contacts	Pin no.	Contacts	Pin no.				
A1-A2	1-2	A1-A2	1-2	A1-A2	1-2	A1-A2	1-2	A1-A2	1-2	A1-A2	1-2	A1-A2	1-2	A1-A2	1-2	A1-A2	1-2	A1-A2	1-2	A1-A2	1-2		
NC	3-4	NC	3-4	NC	3-4	NO	3-4	NC	3-4	NC	3-4	NC	3-4	NC	3-4	NC	3-4	NC	3-4	NC	3-4	NC	3-4
NC	5-6	NC	5-6	NC	5-6	NC	5-6	NC	5-6	NC	5-6	NC	5-6	NC	5-6	NC	5-6	NC	5-6	NC	5-6	NC	5-6
NO	7-8	NC	7-8	NC	7-8	NC	7-8	NC	7-8	NO	7-8	NC	7-8	NC	7-8	NC	7-8	NC	7-8	NC	7-8	NO	7-8
NO	9-10	NO	9-10	NC	9-10	NC	9-10	NO	9-10	NO	9-10	NC	9-10	NC	9-10	NC	9-10	NO	9-10	NO	9-10	NO	9-10

Contact block 60M 3NO+1NC		Contact block 60N 3NO+1NC		Contact block 60P 4NC		Contact block 60R 2NO+2NC		Contact block 60S 2NO+2NC		Contact block 60T 1NO+3NC		Contact block 60U 4NC		Contact block 60V 2NO+2NC		Contact block 60X 1NO+3NC		Contact block 60Y 2NO+2NC					
Contacts	Pin no.	Contacts	Pin no.	Contacts	Pin no.	Contacts	Pin no.	Contacts	Pin no.	Contacts	Pin no.	Contacts	Pin no.	Contacts	Pin no.	Contacts	Pin no.	Contacts	Pin no.				
A1-A2	1-2	A1-A2	1-2	A1-A2	1-2	A1-A2	1-2	A1-A2	1-2	A1-A2	1-2	A1-A2	1-2	A1-A2	1-2	A1-A2	1-2	A1-A2	1-2	A1-A2	1-2		
NO	3-4	NO	3-4	NC	3-4	NC	3-4	NC	3-4	NC	3-4	NC	3-4	NC	3-4	NO	3-4	NC	3-4	NC	3-4	NC	3-4
NC	5-6	NC	5-6	NC	5-6	NC	5-6	NC	5-6	NC	5-6	NC	5-6	NC	5-6	NC	5-6	NC	5-6	NC	5-6	NC	5-6
NO	7-8	NO	7-8	NC	7-8	NO	7-8	NO	7-8	NC	7-8	NC	7-8	NC	7-8	NO	7-8	NC	7-8	NC	7-8	NO	7-8
NO	9-10	NO	9-10	NC	9-10	NO	9-10	NO	9-10	NO	9-10	NO	9-10	NC	9-10	NO	9-10	NC	9-10	NO	9-10	NO	9-10

Contact block 61A 1NO+3NC		Contact block 61B 2NO+2NC		Contact block 61C 3NO+1NC		Contact block 61D 3NO+1NC		Contact block 61E 3NO+1NC		Contact block 61G 3NO+1NC		Contact block 61H 2NO+2NC		Contact block 61M 3NO+1NC		Contact block 61R 1NO+3NC		Contact block 61S 3NO+1NC			
Contacts	Pin no.	Contacts	Pin no.	Contacts	Pin no.	Contacts	Pin no.	Contacts	Pin no.	Contacts	Pin no.	Contacts	Pin no.	Contacts	Pin no.	Contacts	Pin no.	Contacts	Pin no.		
A1-A2	1-2	A1-A2	1-2	A1-A2	1-2	A1-A2	1-2	A1-A2	1-2	A1-A2	1-2	A1-A2	1-2	A1-A2	1-2	A1-A2	1-2	A1-A2	1-2	A1-A2	1-2
NC	3-4	NC	3-4	NO	3-4	NO	3-4	NO	3-4	NO	3-4	NC	3-4	NO	3-4	NO	3-4	NC	3-4	NO	3-4
NC	5-6	NC	5-6	NC	5-6	NC	5-6	NC	5-6	NC	5-6	NC	5-6	NC	5-6	NC	5-6	NC	5-6	NC	5-6
NC	7-8	NO	7-8	NO	7-8	NO	7-8	NO	7-8	NO	7-8	NO	7-8	NO	7-8	NO	7-8	NC	7-8	NO	7-8
NO	9-10	NO	9-10	NO	9-10	NO	9-10	NO	9-10	NO	9-10	NO	9-10	NO	9-10	NO	9-10	NO	9-10	NO	9-10

Note: the wires connected to pins 11 and 12 of the M12 connector can be used to activate the LEDs in FY series configurations with freely connectable LEDs.



Wiring diagram for M23 connectors

M23 connector, 12-pole

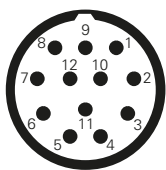

M23 connector, 19-pole

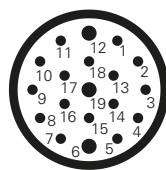

Refer to the diagrams on page 148 (connector pins 11-19) for the connections of the internal terminal strip of the control devices

Contact block 60A 2NO+2NC		Contact block 60B 1NO+3NC		Contact block 60C 4NC		Contact block 60D 1NO+3NC		Contact block 60E 1NO+3NC		Contact block 60F 2NO+2NC		Contact block 60G 4NC		Contact block 60H 4NC		Contact block 60I 1NO+3NC		Contact block 60L 2NO+2NC							
Contacts	Pin no.	Contacts	Pin no.	Contacts	Pin no.	Contacts	Pin no.	Contacts	Pin no.	Contacts	Pin no.	Contacts	Pin no.	Contacts	Pin no.	Contacts	Pin no.	Contacts	Pin no.	Contacts	Pin no.				
A1-A2	1-2	A1-A2	1-2	A1-A2	1-2	A1-A2	1-2	A1-A2	1-2	A1-A2	1-2	A1-A2	1-2	A1-A2	1-2	A1-A2	1-2	A1-A2	1-2	A1-A2	1-2				
NC	3-4	NC	3-4	NC	3-4	NO	3-4	NC	3-4	NC	3-4	NC	3-4	NC	3-4	NC	3-4	NC	3-4	NC	3-4	NC	3-4		
NC	5-6	NC	5-6	NC	5-6	NC	5-6	NC	5-6	NC	5-6	NC	5-6	NC	5-6	NC	5-6	NC	5-6	NC	5-6	NC	5-6	NC	5-6
NO	7-8	NC	7-8	NC	7-8	NC	7-8	NC	7-8	NO	7-8	NC	7-8	NC	7-8	NC	7-8	NC	7-8	NC	7-8	NO	7-8	NO	7-8
NO	9-10	NO	9-10	NC	9-10	NC	9-10	NO	9-10	NO	9-10	NC	9-10	NC	9-10	NC	9-10	NO	9-10	NO	9-10	NO	9-10	NO	9-10

Contact block 60M 3NO+1NC		Contact block 60N 3NO+1NC		Contact block 60P 4NC		Contact block 60R 2NO+2NC		Contact block 60S 2NO+2NC		Contact block 60T 1NO+3NC		Contact block 60U 4NC		Contact block 60V 2NO+2NC		Contact block 60X 1NO+3NC		Contact block 60Y 2NO+2NC							
Contacts	Pin no.	Contacts	Pin no.	Contacts	Pin no.	Contacts	Pin no.	Contacts	Pin no.	Contacts	Pin no.	Contacts	Pin no.	Contacts	Pin no.	Contacts	Pin no.	Contacts	Pin no.	Contacts	Pin no.				
A1-A2	1-2	A1-A2	1-2	A1-A2	1-2	A1-A2	1-2	A1-A2	1-2	A1-A2	1-2	A1-A2	1-2	A1-A2	1-2	A1-A2	1-2	A1-A2	1-2	A1-A2	1-2				
NO	3-4	NO	3-4	NC	3-4	NC	3-4	NC	3-4	NC	3-4	NC	3-4	NC	3-4	NC	3-4	NO	3-4	NC	3-4	NC	3-4		
NC	5-6	NC	5-6	NC	5-6	NC	5-6	NC	5-6	NC	5-6	NC	5-6	NC	5-6	NC	5-6	NC	5-6	NC	5-6	NC	5-6	NC	5-6
NO	7-8	NO	7-8	NC	7-8	NO	7-8	NO	7-8	NC	7-8	NC	7-8	NC	7-8	NO	7-8	NC	7-8	NO	7-8	NO	7-8	NO	7-8
NO	9-10	NO	9-10	NC	9-10	NO	9-10	NO	9-10	NO	9-10	NC	9-10	NC	9-10	NO	9-10	NC	9-10	NO	9-10	NO	9-10	NO	9-10

Contact block 61A 1NO+3NC		Contact block 61B 2NO+2NC		Contact block 61C 3NO+1NC		Contact block 61D 3NO+1NC		Contact block 61E 3NO+1NC		Contact block 61G 3NO+1NC		Contact block 61H 2NO+2NC		Contact block 61M 3NO+1NC		Contact block 61R 1NO+3NC		Contact block 61S 3NO+1NC							
Contacts	Pin no.	Contacts	Pin no.	Contacts	Pin no.	Contacts	Pin no.	Contacts	Pin no.	Contacts	Pin no.	Contacts	Pin no.	Contacts	Pin no.	Contacts	Pin no.	Contacts	Pin no.	Contacts	Pin no.				
A1-A2	1-2	A1-A2	1-2	A1-A2	1-2	A1-A2	1-2	A1-A2	1-2	A1-A2	1-2	A1-A2	1-2	A1-A2	1-2	A1-A2	1-2	A1-A2	1-2	A1-A2	1-2				
NC	3-4	NC	3-4	NO	3-4	NO	3-4	NO	3-4	NO	3-4	NC	3-4	NC	3-4	NO	3-4	NC	3-4	NO	3-4	NO	3-4		
NC	5-6	NC	5-6	NC	5-6	NC	5-6	NC	5-6	NC	5-6	NC	5-6	NC	5-6	NC	5-6	NC	5-6	NC	5-6	NC	5-6	NC	5-6
NC	7-8	NO	7-8	NO	7-8	NO	7-8	NO	7-8	NO	7-8	NO	7-8	NO	7-8	NO	7-8	NC	7-8	NO	7-8	NO	7-8	NO	7-8
NO	9-10	NO	9-10	NO	9-10	NO	9-10	NO	9-10	NO	9-10	NO	9-10	NO	9-10	NO	9-10	NO	9-10	NO	9-10	NO	9-10	NO	9-10

Note: the wires connected to pins 11 and 12 of the M23 12-pole connector can be used to activate the LEDs in FY series configurations with freely connectable LEDs.