

# PRODUCT DATASHEET

## PL CMFT 625 P 28W 840 DALIVR

PANEL COMFORT 625 DALI | Square recessed panel luminaire, for 625 x 625 mm ceiling systems and DALI-2 IoT technology

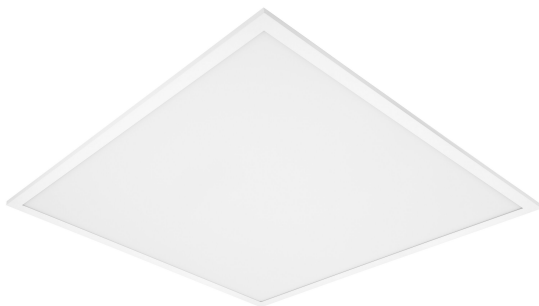

### Areas of application

- Direct replacement for recessed luminaires with fluorescent lamps
- Offices, conference rooms
- Reception areas, foyers, corridors, elevators
- Suitable for recessed ceiling systems with grid size of 625 x 625 mm

### Product benefits

- Suitable luminaire for VIVARES and other DALI-2 Light Management Systems
- Tool-free electrical connection due to push button connector
- Through-wiring possible with included connector box
- Energy savings thanks to high system efficacy: up to 130 lm/W
- High color consistency with SDCM 3
- Extended services such as energy monitoring and remote maintenance possible with DALI versions
- External driver for extended flexibility and easy installation
- Low flicker light thanks to special electronic control gear
- Suitable for emergency lighting
- 5 years guarantee

### Product features

- IoT-ready luminaire with DALI-2 technology
- Suitable for central battery emergency installations acc. to EN 60598-2-22



- Push DIM function for dimming and switching directly on a pushbutton
- Extruded aluminum frame
- Polystyrene diffuser
- 5-pole terminal block, cable cross section up to 5 x 2.5 mm<sup>2</sup>
- Lifetime (L80/B10): 70,000 h (at 25 °C)

## TECHNICAL DATA

### Electrical data

|   |                       |
|---|-----------------------|
| Nominal wattage   | 28.00 W <sup>1)</sup> |
| Nominal voltage   | 220...240 V           |
| Mains frequency   | 0/50/60 Hz            |
| Nominal current   | 130.000 mA            |
| Inrush current  | 4.4 A                 |
| Inrush current time $T_{h50}$                               | 440 $\mu$ s           |
| Max. number of luminaires per miniature circuit breaker B16 | 40                    |
| Max. number of luminaires per miniature circuit breaker C10 | 40                    |
| Max. number of luminaires per miniature circuit breaker C16 | 65                    |
| Power factor $\lambda$                                      | > 0.90                |
| Total harmonic distortion                                   | < 20 %                |
| Protection class  | II                    |
| Operating mode  | External LED driver   |
| Dimming interface   | DALI-2 / IoT          |

<sup>1)</sup> CRI80 versions of the Panel Comfort family are fulfilling the technical minimum requirements according to the German BEG subsidy program for energy efficient luminaires

### Photometrical data

|  |                        |
|--|------------------------|
| Luminous flux                                | 3640 lm <sup>1)</sup>  |
| Luminous efficacy                            | 130 lm/W <sup>1)</sup> |
| Color temperature                            | 4000 K                 |
| Light color (designation)                    | Cool White             |
| Color rendering index Ra                     | > 80                   |
| Standard deviation of color matching         | $\leq$ 3 sdcM          |
| Low flicker                                  | Yes                    |
| Flickering metric (Pst LM)                   | <1                     |
| Stroboscope effect metric (SVM)              | < 0.4                  |
| Photobiological safety group acc. to EN62778 | RG0                    |
| Beam angle                                   | 110 °                  |

<sup>1)</sup> CRI80 versions of the Panel Comfort family are fulfilling the technical minimum requirements according to the German BEG subsidy program for energy efficient luminaires

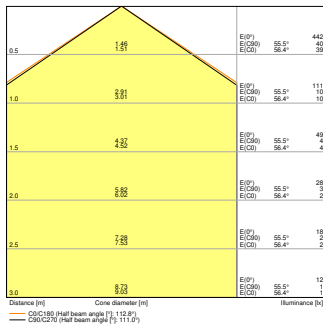

PL CMFT 625 P 28W 840 DALIVR  
EM CONVERSION BOX

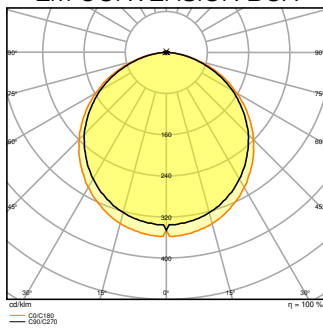

PL CMFT 625 P 28W 840 DALIVR  
EM CONVERSION BOX

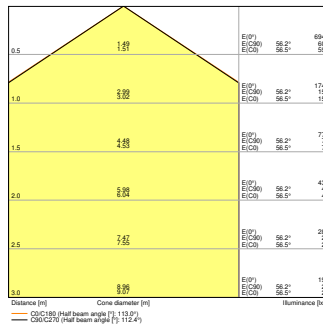

PL CMFT 625 P 28W 840 DALIVR  
EM

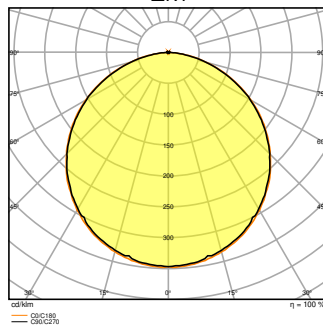

PL CMFT 625 P 28W 840 DALIVR  
EM

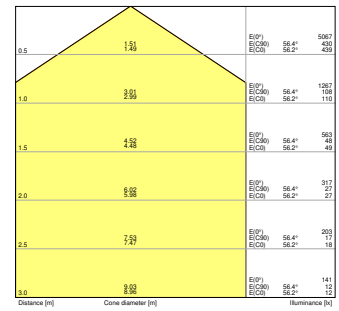

PL CMFT 625 P 28W 840 DALIVR

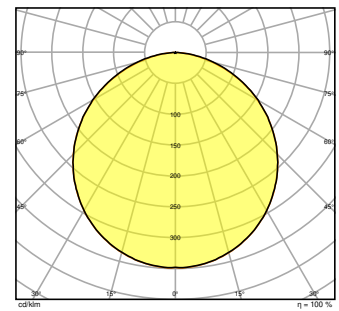

PL CMFT 625 P 28W 840 DALIVR

Dimensions & Weight

|                |           |
|----------------|-----------|
| Length         | 620.00 mm |
| Width          | 620.00 mm |
| Height         | 32.00 mm  |
| Product weight | 2010.00 g |

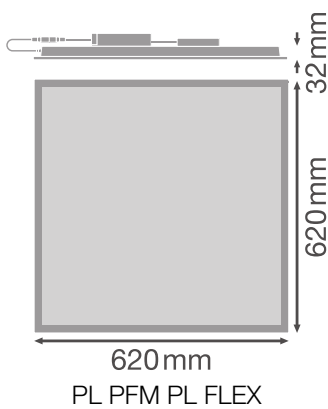

## Materials & Colors

|  |                  |
|--|------------------|
| Product color                              | White            |
| Housing color                              | White            |
| Body material                              | Steel            |
| Cover material                             | Polystyrene (PS) |
| Light emitting surface material            | Polystyrene      |
| Glow Wire Test according to IEC 60695-2-12 | 650 °C           |
| Mercury content                            | 0.0 mg           |

## Application & Mounting

|  |   |
|--|---|
| Ambient temperature range              | -10...+50 °C                                    |
| Temperature range at storage           | -20...+80 °C                                    |
| Type of connection                     | Screwless terminal, 5-Pole (L, N, PE, DA+, DA-) |
| Type of protection                     | IP40/IP20                                       |
| Protection class IK (shock resistance) | IK02  |
| Dimmable                               | Yes   |
| Type of dimming                        | DALI2   |
| Mounting type                          | Recessed/Suspended/Surface                      |
| Mounting location                      | Ceiling   |
| Application environment                | Indoor  |
| Mounting length                        | 600,0 mm  |
| Mounting width                         | 600,0 mm  |
| Mounting depth                         | 50,0 mm   |
| Adjustable                             | No  |
| With light source                      | Yes   |

## Lifespan

|                            |                        |
|----------------------------|------------------------|
| Lifespan L70/B50 at 25 °C  | 100000 h <sup>1)</sup> |
| Lifespan L80/B10 at 25 °C  | 70000 h <sup>1)</sup>  |
| Lifespan L80/B50 at 25 °C  | 70000 h                |
| Lifespan L90/B10 at 25 °C  | 48000 h                |
| Number of switching cycles | 50000                  |

<sup>1)</sup> t[h]: L70 / B50 @ 25 °C (Ta), t[h]: L80 / B10 @ 25 °C (Ta), t[h]: L90 / B10 @ 25 °C (Ta)

## Control gear

|                             |   |
|-----------------------------|---|
| Output current              | 620 mA  |
| ECG - Output ripple current | < 5 %   |
| ECG - Length                | 209,00 mm   |
| ECG - Width                 | 42.5 mm   |
| ECG - Height                | 30 mm   |
| Recommended control gear    | OSRAM OTI DALI 50/220-240/1A4 NFC; Tridonic LCA 45W 500-1400mA one4all SC PRE |

**Emergency lighting**

|   |        |
|---|--------|
| Wattage in emergency operation mode       | 5.5 W  |
| Luminous flux in emergency operation mode | 500 lm |



**Certificates & Standards**



|  |                                   |
|--|-----------------------------------|
| Standards  | CE / CB / ENEC / UKCA / EAC / EPD |
| Luminaire with limited surface temperature, "D sign" | No                                |
| Ball shot safe                                       | No                                |
| EPD  | LEDV-00011-V01.01-EN              |
| Replaceable light source (EPREL)                     | Not replaceable                   |

**Additional product data**

|                |         |
|----------------|---------|
| Added function | VIVARES |
|----------------|---------|

**Accessories Optional**









| Product image   | Product name                        | EAN           |
|---|-------------------------------------|---------------|
|  | EM CONVERSION BOX                   | 4058075237025 |
|  | PANEL 625 SURFACE MOUNT KIT H70 VAL | 4058075402867 |
|   | PANEL 625 RECESSED MOUNT FRAME      | 4058075402904 |

















| Product image   | Product name                      | EAN           |
|---|-----------------------------------|---------------|
|  | PANEL RECESSED MOUNT CLIPS VAL 4x | 4058075409859 |
|  | PANEL Suspension Kit              | 4058075402928 |

**EQUIPMENT / ACCESSORIES**

- Accessories for several mounting options available
- Connector box with 5-pole terminal included
- Security brackets preinstalled
- External control gear included
- Suitable for use with separate Emergency Conversion Box

**DOWNLOAD DATA**

| Documents and certificates  | Document name                                    |
|---|--|
|  User instruction / safety instructions | PL CMFT P DALIVR                                 |
|  Legal information                      | LISO Insert Panel CMFT 600 P DALI and 625 P DALI |
|  Legal information                      | Informationstext 18 Abs 4 ElektroG               |
|  Legal information                      | EM Insert PL COMFORT                             |
|  Declarations of conformity             | CE Declaration PL CMFT DALI                      |
|  Declarations of conformity             | CE Declaration PL CMFT DALIVR                    |
|  Declarations of conformity UKCA        | UKCA Declaration PL CMFT DALI                    |
|  Declarations of conformity UKCA        | UKCA Declaration PL CMFT DALIVR                  |
|  Declarations of conformity UKCA        | PL COMFT P DALIVR                                |

| Photometric and lighting design files  |                                     | Document name                                  |
|--|-------------------------------------|--|
|    | IES file (IES)                      | PL CMFT 625 P 28W 840 DALIVR                   |
|    | LDT file (Eulumdat)                 | PL CMFT 625 P 28W 840 DALIVR                   |
|    | ULD file (DIALux)                   | PL CMFT 625 P 28W 840 DALI                     |
|    | ROLF file (RELUX)                   | PL CMFT 625 P 28W 840 DALI                     |
|    | UGR file (UGR table)                | PL CMFT 625 P 28W 840 DALIVR EM CONVERSION BOX |
|    | UGR file (UGR table)                | PL CMFT 625 P 28W 840 DALIVR EM                |
|    | UGR file (UGR table)                | PL CMFT 625 P 28W 840 DALIVR                   |
|    | Light distribution curve type cone  | PL CMFT 625 P 28W 840 DALIVR EM CONVERSION BOX |
|    | Light distribution curve type cone  | PL CMFT 625 P 28W 840 DALIVR EM                |
|   | Light distribution curve type cone  | PL CMFT 625 P 28W 840 DALIVR                   |
|  | Light distribution curve type polar | PL CMFT 625 P 28W 840 DALIVR EM CONVERSION BOX |
|  | Light distribution curve type polar | PL CMFT 625 P 28W 840 DALIVR EM                |
|  | Light distribution curve type polar | PL CMFT 625 P 28W 840 DALIVR                   |
| CAD/BIM files  |                                     | Document name                                  |
|  | BIM Revit 3D                        | PL_CMFT  |
|  | CAD STEP 3D                         | PL_CMFT_625                                    |
| Tender texts   |                                     | Document name                                  |
|  | Tender documents                    | PANEL COMFORT 625 DALI 28W 840 DALIVR-EN       |

**LOGISTICAL DATA**

| Product code  | Packaging unit (Pieces/Unit) | Dimensions (length x width x height) | Gross weight | Volume                 |
|---------------|------------------------------|--------------------------------------|--------------|------------------------|
| 4099854014314 | Folding box<br>1             | 52 mm x 647 mm x 719 mm              | 2522.00 g    | 24.19 dm <sup>3</sup>  |
| 4099854014321 | Shipping box<br>4            | 672 mm x 227 mm x 749 mm             | 12218.00 g   | 114.26 dm <sup>3</sup> |



The mentioned product code describes the smallest quantity unit which can be ordered. One shipping unit can contain one or more single products. When placing an order, for the quantity please enter single or multiples of a shipping unit.

---

### ADDITIONAL CATALOG INFORMATION

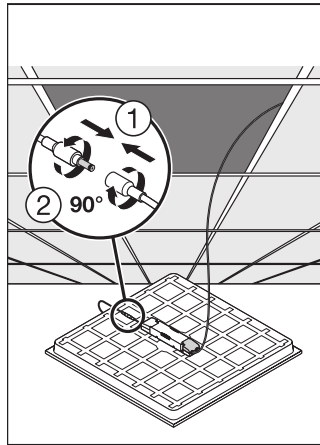
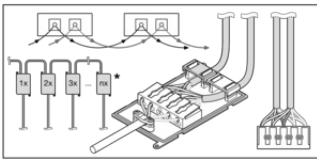

### References / Links

– For Guarantee see [www.ledvance.com/guarantee](http://www.ledvance.com/guarantee)

---

### DISCLAIMER

Subject to change without notice. Errors and omission excepted. Always make sure to use the most recent release.