

PRODUCT DATASHEET

SF BLKH S 300 P EM 15W 840 WT IP65

SURFACE BULKHEAD 300 SENSOR EMERGENCY | Robust wall and ceiling luminaire with IP65 protection, high-frequency sensor and integrated emergency lighting function



Areas of application

- Emergency illumination of escape routes
- Antipanic lighting
- Buildings requiring up to 3 h emergency light operation
- Direct replacement for luminaires with fluorescent lamps
- Corridors, stairways, entrance areas
- Passages, underpasses
- Public areas

Product benefits

- Multiple adjustments of sensor range, daylight detection and hold time
- Seamless integration of luminaires with emergency lighting function into general lighting
- Easy wiring thanks to included prewired driver and battery for Emergency lighting function
- Separate covers available for an aesthetic and functional product design
- 3 years guarantee
- Operation of integrated emergency lighting function with long life LiFePO4 battery with 3h battery discharge time
- High luminous efficacy in normal operation
- Suitable for use in dusty and damp locations thanks to high IP rating
- Suitable for use in public areas thanks to high IK rating
- Multiple mounting patterns for convenient installation
- Convenient visualization of results of automatic test with an included control LED
- Simple testing of luminaires with emergency lighting function thanks to integrated automatic test function

Product features

- High frequency sensor for daylight and motion detection
- Certified according to European norms (EN 60598-1:2015; EN 60598-2-22:2014)
- Luminaire suited for normal lighting and emergency lighting
- Self-contained luminaires
- Emergency lighting function: battery discharge time of 3 h

- Function test of emergency lighting: automatic (AT)
- Battery technology: LiFePO4
- Ambient temperature in operation: 5°...+40 C
- UV-stabilized polycarbonate (PC) housing, PC-diffuser
- Impact resistance: IK10
- Push wire terminal for tool-free connection
- Through-wiring possible

TECHNICAL DATA

Electrical data

Nominal wattage	15.00 W
Nominal voltage	220...240 V
Mains frequency	50...60 Hz
Nominal current	350.000 mA
Inrush current	3.47 A
Inrush current time T_{h50}	490 μ s
Max. number of luminaires per miniature circuit breaker B16	48
Max. number of luminaires per miniature circuit breaker C10	48
Max. number of luminaires per miniature circuit breaker C16	78
Power factor λ	≥ 0.7
Total harmonic distortion	< 8 %
Protection class	II
Operating mode	Integrated LED driver

Photometrical data

Luminous flux	1400 lm
Luminous efficacy	93 lm/W
Color temperature	4000 K
Light color (designation)	Cool White
Color rendering index Ra	> 80
Standard deviation of color matching	< 5 sdc _m
Luminous intensity	-
Low flicker	Yes
Flickering metric (Pst LM)	-
Stroboscope effect metric (SVM)	-
Photobiological safety group acc. to EN62778	RG0
Photobiological safety group acc. to EN62471	RG0
Beam angle	120 °

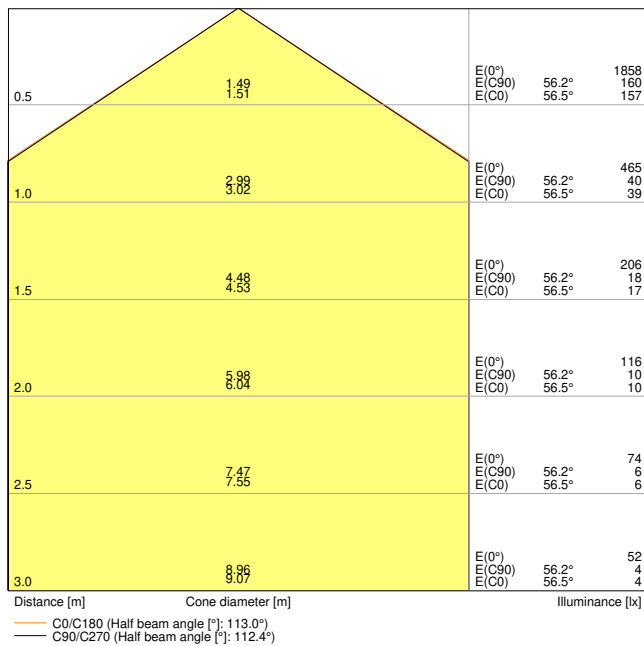

SF BLKH S 300 P 15W 840 WT IP65 EM

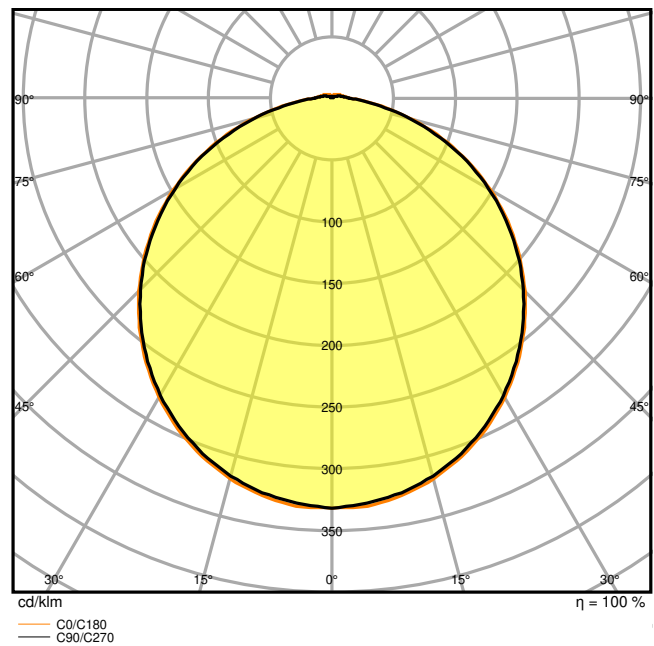

SF BLKH S 300 P 15W 840 WT IP65 EM

Dimensions & Weight

Diameter	300.00 mm
Height	70.00 mm
Product weight	1060.00 g

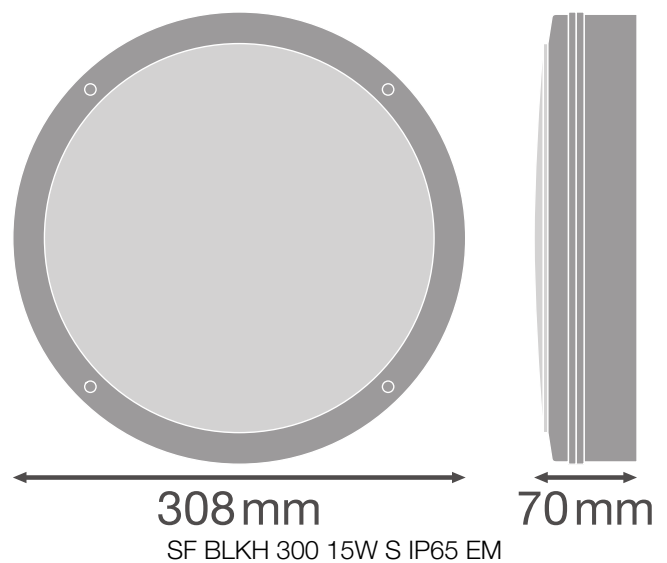
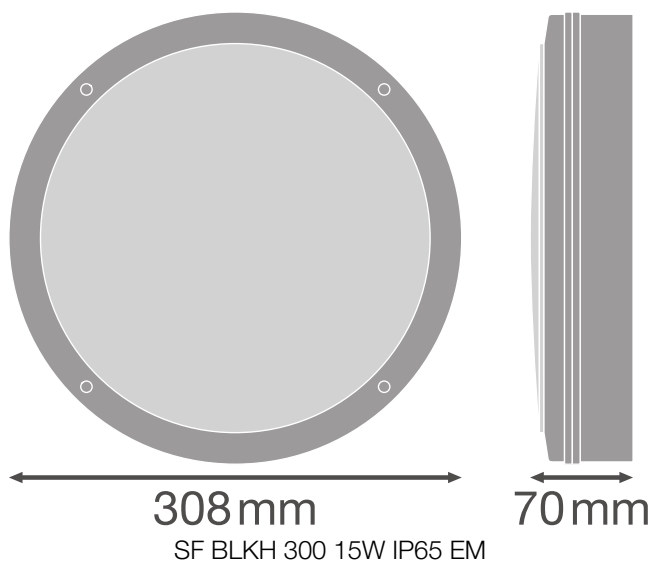

Materials & Colors

Product color	White
---------------	-------

Housing color	White
Body material	Polycarbonate (PC)
Cover material	Polycarbonate (PC)
Light emitting surface material	Polycarbonate (PC)
Glow Wire Test according to IEC 60695-2-12	850 °C
Mercury content	0.0 mg

Application & Mounting

Ambient temperature range	+5...+40 °C
Type of connection	Screwless terminal
Type of protection	IP65
Protection class IK (shock resistance)	IK10
Dimmable	No
Mounting type	Surface
Mounting location	Ceiling / Wall
Application environment	Outdoor
With light source	Yes

Lifespan

Lifespan L70/B50 at 25 °C	50000 h ¹⁾
Lifespan L80/B10 at 25 °C	35000 h ¹⁾
Lifespan L80/B50 at 25 °C	35000 h
Lifespan L90/B10 at 25 °C	20000 h
Number of switching cycles	100000

¹⁾ t[h]: L70 / B50 @ 25 °C (Ta), t[h]: L80 / B10 @ 25 °C (Ta), t[h]: L90 / B10 @ 25 °C (Ta)

Control gear

Output current	350 mA
----------------	--------

Sensor

Type of sensor	Motion / Light
Sensor technology	Microwave
Sensor detection angle	150 °
Sensor controlled switching time	5 s...30 min
Detection range of motion sensor	3...8 m
Detection threshold of daylight sensor	2...50 lx
Sensor IP rating	IP20

BATTERY

Type of Battery	LiFePO4
Battery size [GMS]	Others
Nominal voltage of battery	3.2 V
Nominal capacity of battery	4500 mAh
Battery charging time	< 24 h

Emergency lighting

Area of emergency application	Anti-panic lighting / Escape route lighting
Type of emergency light operation	Maintained / Non-maintained
Type of emergency operation test	None
Wattage in maintained operation mode	16.5 W
Wattage in emergency operation mode	3,0 W
Luminous flux in maintained operation mode	1400 lm
Luminous flux in emergency operation mode	350 lm
Battery life in emergency operation mode	3 h
Integrated test switch	No

Certificates & Standards

Standards	CE / CB
Luminaire with limited surface temperature, "D sign"	No
Ball shot safe	No
Replaceable light source (EPREL)	Not replaceable



EQUIPMENT / ACCESSORIES







- Additional cover rings in different designs available
- Mounting screws and dowels included

Safety advice



- All electrical connections must be made by a qualified person.
- Caution, risk of electric shock.

DOWNLOAD DATA

Documents and certificates	Document name
 User instruction / safety instructions	SF BLKH 250, 300 P IP65 EM
 Legal information	LS Insert SF Bulkhead Sensor P

Documents and certificates		Document name
	Legal information	LS Insert SF Bulkhead P EM
	Legal information	Legal insert SF BLKG S P IP65 EM
	Legal information	Informationstext 18 Abs 4 ElektroG
	Declarations of conformity	EC declaration SF BLKH S EM LUM
	Declarations of conformity UKCA	SF BLKH S IP65 EM
	Declarations of conformity UKCA	SF BLKH S P IP65 EM

Photometric and lighting design files		Document name
	IES file (IES)	SF BLKH 300 15W 4000K S WT IP65 EM
	IES file (IES)	SF BLKH 300 15W 4000K S WT IP65 EM
	IES file (IES)	SF BLKH 300 15W 4000K S WT IP65 EM
	LDT file (Eulumdat)	SF BLKH 300 15W 4000K S WT IP65 EM
	LDT file (Eulumdat)	SF BLKH 300 15W 4000K S WT IP65 EM
	LDT file (Eulumdat)	SF BLKH 300 15W 4000K S WT IP65 EM
	ULD file (DIALux)	SF BLKH S EM WT
	ROLF file (RELUX)	SF BLKH S EM WT
	UGR file (UGR table)	SF BLKH S 300 P 15W 840 WT IP65 EM
	Light distribution curve type cone	SF BLKH S 300 P 15W 840 WT IP65 EM
	Light distribution curve type polar	SF BLKH S 300 P 15W 840 WT IP65 EM

CAD/BIM files		Document name
	BIM Revit 3D	Surface Bulkhead
	CAD STEP 3D	SF BLKH 300

