

SpaceLogic Sensors

Air Quality Sensors – BACnet and Modbus



Note: A subset of models shown.

Product Description

The SpaceLogic SLP Series of air quality sensors for living space is a flexible multisensor platform for use with BAS controllers designed to accept BACnet or Modbus outputs. Housings are available in Medium matte white and Optimum faces available in black and white. All housing types are available with three user interface options: touchscreen, LCD with three buttons and blank. CO₂ and temperature sensors are included with all SLP Series air quality sensors. Models with VOC sensors and relative humidity sensors are also available.

Features

- Medium matte white housing or optimum glass panel housing available in white or black
- Field calibratable non-dispersive infrared CO₂ sensor
- Replaceable RH element available in 1% & 2% with NIST certificate
- VOC sensor available
- Temperature output on all models
- 61 mm (2.4") backlit color touchscreen and LCD, three button display options available
 - Digital temperature indication (0.1° display resolution of °F or °C)
 - Digital humidity indication (0.1% RH display resolution)
 - Digital CO₂ indication (0 to 2000 ppm display resolution)
 - Stoplight feature for visual indication at user-configurable CO₂ threshold levels (touchscreen models only)
 - Selectable temp, RH and fan speed setpoint
 - Configurable screen/button lock and display timeout
 - Override
- Selectable BACnet MSTP and Modbus outputs via RS-485
- 18-24 AWG screw terminals

Available Products Matrix

SLP	Housing	User Interface	CO ₂ Sensor	RH Sensor*	Example:
	<input type="checkbox"/>	<input type="checkbox"/>	<input type="checkbox"/>	<input type="checkbox"/>	SLP <input type="checkbox"/> <input type="checkbox"/> <input type="checkbox"/> <input type="checkbox"/>
	S = Medium white matte housing W = Optimum white housing B = Optimum black housing	T = Color touchscreen L = 3-button LCD display X = None	C = NDIR CO ₂ CV = NDIR CO ₂ / VOC	2 = 2% X = None	

*Replaceable RH module available to be ordered separately per table below.

Replaceable RH Elements

Model	RH Accuracy	Calibration Certificate	Description
SLXRHS1N	±1%	X	Replaceable RH sensor, 1% with NIST certification
SLXRHS2N	±2%	X	Replaceable RH sensor, 2% with NIST certification
SLXRHS2X	±2%		Replaceable RH sensor, 2%

USA: +1 888-444-1311
 Europe: +46 10 478 2000
 Asia: +65 6484 7877
www.schneider-electric.com

Life Is On



Specifications

Operating Environment			
Input power	Class 2; 20 to 30 Vdc, 24 Vac, 50 to 60 Hz		
Protocol output	BACnet or Modbus via RS-485, selectable		
Operating temp. range	0 to 50 °C (32 to 122 °F)		
Operating humidity range	0 to 95% RH non-condensing		
Housing material	High impact ABS plastic		
IP rating	IP 30		
Mounting location	For indoor use only. Not suitable for wet locations.		
Surface mount	The device can be surface mounted on Single Gang J-Box, British Standard and CE60 wall boxes		
CO ₂ Sensor			
Sensor type	Non-dispersive infrared (NDIR), diffusion sampling		
Output range	0 to 2000 ppm		
Accuracy	±30 ppm ±3% of measured value		
Repeatability	±20 ppm ±1% of measured value		
Response time	<60 seconds for 90% step change		
VOC Sensor			
Sensor type	Solid state		
Output range	0 to 100% AQI for VOC		
Accuracy	±15% of measured value		
Output scale	0 to 1,000 ppb of total VOC (TVOC)		
AQI table*	Level	Ventilation Recommendation	TVOC (ppb)
	>61%	Greatly increased	>610
	20 to 61%	Significantly increased	200 to 610
	10 to 20%	Slightly increased	100 to 200
	5 to 10%	Average	50 to 100
0 to 5%	Target value	0 to 50	
RH Sensor			
HS sensor	Thin-film capacitive, replaceable		
Accuracy	±2% from 10 to 80% RH @ 25°C (77 °F)		
Hysteresis	1.5% typical		
Linearity	Included in accuracy specification		
Stability	±1% @ 20°C (68 °F) annually for 2 years		
Output range	0 to 100% RH		
Temperature coefficient	±0.1% RH/°C above or below 25 °C (77 °F) typical		
Temperature Sensor			
Sensor type	Solid state, integrated circuit		
Accuracy	±0.2 °C (±0.4 °F) typical		
Resolution	0.1 °C (0.1 °F)		

Range	0 to 50 °C (32 to 122 °F)
Display Models	
Touchscreen	61 mm (2.4 in), color, backlit, capacitive, 240x300px Setpoint: Temperature, humidity or fan speed selectable Timeout override: Display timeout Lockout override: Touchscreen/button lockout
	52mm (2.05 in), segmented with 3 buttons Setpoint: Temperature, humidity or fan speed selectable Timeout override: Display timeout Lockout override: Touchscreen/button lockout
LCD	
Setpoints	
Temperature setpoint	Scale: 0 to 50 °C (32 to 122 °F) max., adjustable span
Humidity setpoint	Scale: 0 to 100% RH
Fan speed setpoint	Off, Low, Medium, High, Auto
Override	
Override button	Display models feature a momentary override button
Wiring Terminals	
Terminal blocks	Screw terminals, 18-24 AWG
Screw terminal torque	0.2 N-m (2.0 in-lbf) max.
Regulatory Information	
	UL 916, European conformance CE: EN61000-6-2 EN61000-6-3 EN61000 Series - industrial immunity EN 61326-1 FCC Part 15 Class B, REACH, RoHS, Green Premium, RCM (Australia), ICES-003 (Canada), EAC (Russia)
Agency approvals	

* Air Quality Index for VOC aligns with TVOC levels for IAQ as specified by the WHO (World Health Organization).

Dimensions mm (in.)

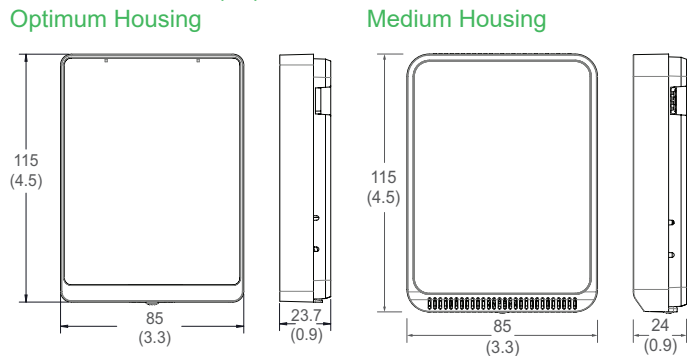

USA: +1 888-444-1311
Europe: +46 10 478 2000
Asia: +65 6484 7877
www.schneider-electric.com

Life Is On

Schneider Electric

Dimensions mm (in.), cont.
Base Hole Measurement

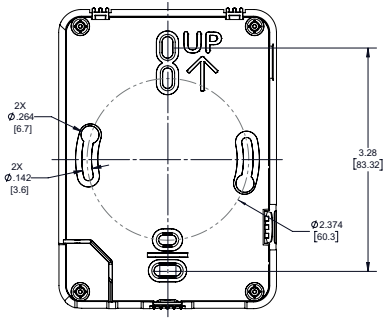

Installation

1. Remove the cover from the base at the bottom of the device.



2. Position the sensor base vertically on the wall 1.35 m (4.5 ft.) above the floor with the “UP” arrow facing upward. Locate away from windows, vents and other sources of draft. If possible, do not mount on an external wall, as this may cause inaccurate temperature readings.



3. Pull 18 or 22 AWG cable(s) through the hole in the backplate.

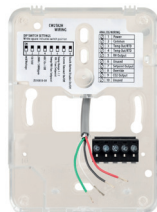

4. Mount the backplate onto the wall using the screws provided.

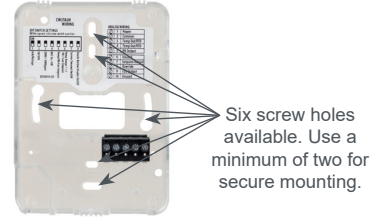

5. Connect the wires to the screw terminals. Do not over-tighten the screws.

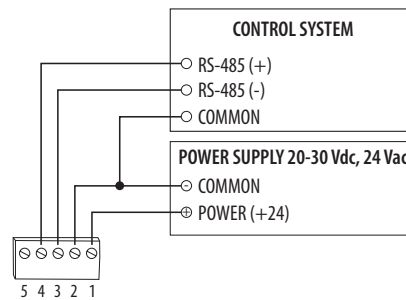

6. Configure the device.

Address Configuration:

Each device on a single network must have a unique address. Set the DIP switch labeled “ADDRESS” to assign a unique address before the device is connected to the network. If an address is selected that conflicts with another device, neither device will be able to communicate.

Address the device as any whole number between and including 1 to 127. Note that zero is not a valid address for Modbus; zero is a valid address for BACnet. Positions 1 through 7 of the “ADDRESS” DIP switch designate the address. Position 8 toggles between the Modbus and BACnet

communication protocols, as shown in the diagram below. This is the left bank of DIP switches on the sensor.

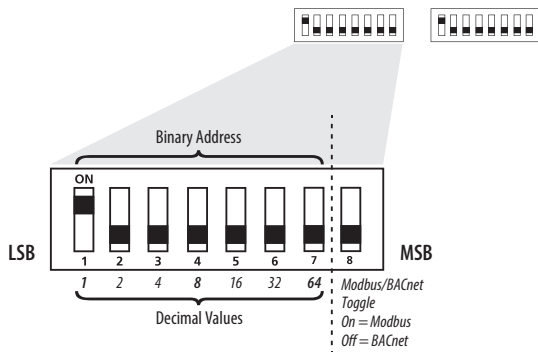

To set an address using the DIP switch, simply add the values of any switches that are in the ON position.

For example, an address of 73 is set as shown in the diagram below.

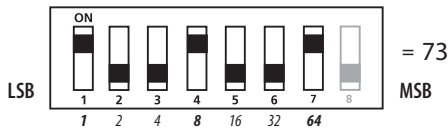

Position number 1 has an ON value of 1, position number 4 has an ON value of 8 and position number 7 has an ON value of 64 (1 + 8 + 64 = 73).

Communications Configuration:

See the Product Diagram section for the location of the DIP switch labeled “CONFIG”. The following parameters are configurable:

- Parity (Modbus only): None, Odd, None1 (one stop bit), Even
- Baud rate: 9600, 19200, 38400, 57600 (Modbus), 76800 (BACnet)

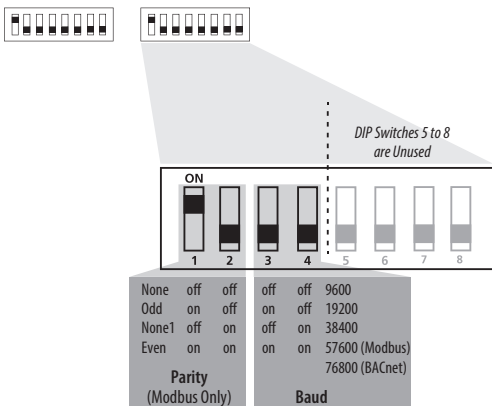

Example: No Parity, 19200 Baud

1	2	3	4	5	6	7	8
off	off	on	off	off	off	off	off
None		19200 Baud		Unused			

Modbus Point Map

Function Codes:

Function Code	Function
03	Read holding (RW) registers
04	Read input (RO) registers
06	Write single register*
16	Write multiple registers
01	Read coils
05	Write single coil
15	Write multiple coils

* Not supported.

All of these values correspond to BACnet objects with the same name. See the BACnet Conformance Statement for their definitions.

Note that an attempt to write to “read only” holding registers will give an error and the entire write command will not be executed even if writing to read/write locations were also requested. Exception code 2 is given in this case. “Preserved” means the values is maintained through power outages.

32-Bit Input Registers (Read Only):

Register	Description
1	Temperature reading in IEEE 32-bit floating point
3	Humidity reading in IEEE 32-bit floating point
5	CO ₂ reading in IEEE 32-bit floating point
7	VOC reading in IEEE 32-bit floating point
9	Model (numeric representation of ASCII characters)
42	Serial number (numeric representation of ASCII characters)

32-Bit Holding Registers (Read/Write):

Register	Description
1	Temperature setpoint
3	Humidity setpoint
5	Screen color set

Register	Description
7	Device name
40	Fan speed
42	CO ₂ yellow limit
44	CO ₂ red limit

Note: All holding registers are preserved during power outages.

Coils (Read/Write):

Register	Description
2*	CO ₂ stoplight
3*	Touch button disable
4*	Invoke CO ₂ calibration
5*	Temperature (°C)
6	Occupancy override
7*	Touch timeout
8*	Display shows humidity
9*	Display shows CO ₂ level
10*	Display shows VOC level
11	Set 400 ppm as CO ₂ baseline
12*	Display shows temperature setpoint on main screen

* Preserved during power outages.

BACnet Descriptions

Note: In the tables below, all properties are read-only unless otherwise noted. "Preserved" means the value is maintained through power outages.

Present_Value Range Restrictions:

Object Name	Minimum Value	Maximum Value
DEV - Object_ Name	1 Character	65 Characters
Temperature Setpoint	Min_Pres_Value 0	Max_Pres_Value Max_Pres_Value -1
Min_Pres_Value	Min_Pres_Value +1	50
Max_Pres_Value		
Humidity Setpoint	Min_Pres_Value 0	Max_Pres_Value Max_Pres_Value -1
Min_Pres_Value	Min_Pres_Value +1	100
Max_Pres_Value		
Screen Color	1	4
CO ₂ Yellow Limits	400	10,000
CO ₂ Red Limits	400	10,000
Fan Speed	1	5
Device_Instance	0	4,194,302

Standard Object Types Supported:

Object Type	Supported Optional Properties	Writable Properties
Analog Input - AI	Reliability	None

Analog Value - AV	Min_Pres_Value Max_Pres_Value	Min_Pres_Value Max_Pres_Value Present_Value
Binary Value - BV	None	Present Value
Multistate Value - MSV	None	Present Value
Device - DEV	Max Info Frames Max_Master	APDU_Timeout Max_Master Object_Name

Objects Table:

Object Name	Object Identifier	Object Property
Room Temperature	AI 1	Temperature in room
Room Humidity	AI 2	Humidity in room
CO ₂ Sensor	AI 3	CO ₂ concentration
VOC Sensor	AI 4	VOC level
Temperature Setpoint*	AV 1	Setpoint value for temperature
Humidity Setpoint*	AV2	Setpoint value for humidity
CO ₂ Yellow Limits*	AV3	CO ₂ threshold to which the screen color changes from green to yellow
CO ₂ Red Limits*	AV4	CO ₂ threshold to which the screen color changes from yellow to red
CO ₂ Stoplight*	BV 1	ACTIVE enables CO ₂ Stoplight INACTIVE disables CO ₂ Stoplight
Touch Disable*	BV2	ACTIVE disables Touch Response INACTIVE enables Touch Response
CO ₂ ABC Cal*	BV3	ACTIVE enables ABC calibration INACTIVE disables ABC calibration
Temperature Units*	BV4	ACTIVE displays temperature in Fahrenheit INACTIVE displays temperature in Celsius
Occupancy Override	BV5	ACTIVE means room is not occupied INACTIVE means room is occupied
Screen Timeout*	BV 6	ACTIVE enables Screen Timeout INACTIVE disables Screen Timeout

Objects Table (cont.)

Object Name	Object Identifier	Object Property
Display Humidity*	BV7	ACTIVE displays humidity on screen INACTIVE removes humidity from Screen
Display CO2*	BV8	ACTIVE displays CO ₂ level on screen INACTIVE removes CO ₂ level from screen
Display VOC*	BV9	ACTIVE displays VOC level on screen INACTIVE removes VOC level from screen
CO2 FRC 400	BV10	ACTIVE sets 400 ppm as CO ₂ baseline after Present_Value is read INACTIVE leaves CO ₂ baseline in last state (no action)
Select Temperature Display*	BV11	ACTIVE displays temperature setpoint on main screen INACTIVE displays temperature setpoint in upper left corner and current temperature on main screen
Screen Color Set*	MSV 1	Selection for screen color theme
Fan Speed*	MSV 2	Fan speed selection

* Preserved during power outages.

Device Objects Table:

Object Name	Object Identifier	Object Property	Descrip.
Living Space Room Unit XXXXXXXX	Vendor_ID + nnn	Object_Identifier (R/W)	Unique value where nnn initially is the MS/TP address

BACnet Protocol Implementation Conformance Statement

Vendor Name: Schneider Electric
 Product Name: Living Space Room Unit
 Product Model: SLPXXXX
 BACnet Protocol Version : 1
 BACnet Protocol Revision: 16
 Product Description: Environmental Sensor
 BACnet Standardized Device Profile (AnnexL):
 BACnet Application Specific Controller (B-ASC)

List All BACnet Interoperability Building Blocks Supported(Annex K):
 DS-RP-B, DS-RPM-B, DS-WP-B, DM-DDB-B, DM-DOB-B, DM-DCC-B, DM-RD-B

Data Link Layer Options: MS/TP (Clause 9), baud rates, 9600, 19200, 38400, 76800

Device Address Binding: Static Device binding is not supported.

Networking Options: None

Character Sets supported: ISO 10646 (UTF-8)

- With sensor base fully installed, align top of cover to mounting tabs on top of sensor base. Swing cover downward until it latches at the bottom.



- Install locking screw to secure cover in closed position.



CO₂ Sensor Calibration

There are two methods for CO₂ calibration available: 400 ppm baseline calibration and automatic baseline calibration (ABC).

400 ppm Baseline Calibration

400 ppm baseline calibration allows the sensor to be set at 400 ppm. Push and hold the calibration button for 3 to 5 seconds. The LED will flash green. Once the button is released, calibration is complete and the LED switches off.

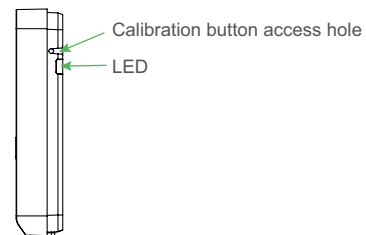

Automatic Baseline Calibration (ABC)

The ABC mode addresses the 400 ppm calibration. It allows turning on or off a background correction/recovery mode that will minimize any calibration error that has been caused by shock during handling and transportation or is caused by a long term shift in measurement. The ABC algorithm constantly keeps track of the sensor’s lowest reading over a preconfigured time interval and slowly corrects for any long-term drift detected as compared to the expected fresh air value of 400 ppm. After initial startup, it is expected that the sensor reaches specified accuracy after 7 to 21 days.

Touchscreen Operation

Main Screen

The touchscreen user interface displays applicable sensor output values (temperature, RH, CO₂ and VOC), setpoint value, menu button and CO₂ stoplight status (if enabled).

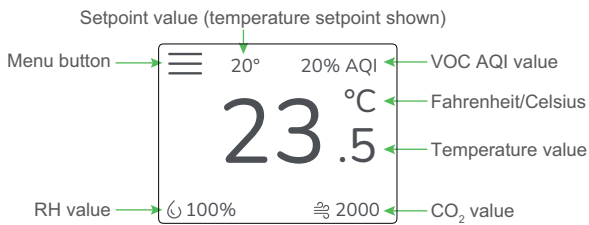

Room Temperature Display Option

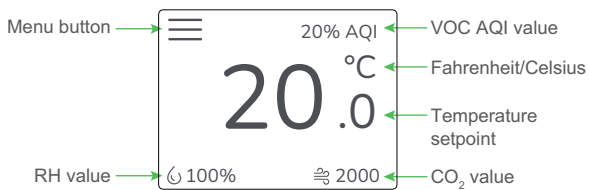

Temperature Setpoint Display Option

Menu Screen

The menu screen opens when pressing the Menu button on the main screen. Integrator’s submenu, occupancy/override, Fahrenheit/Celsius, settings, setpoint submenu (temp, RH and fan) and CO₂ stoplight buttons are displayed on the menu screen.

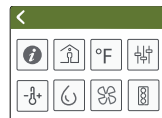



Note: RH setpoint will not appear on non-RH models.

Menu Button Functions

 **Integrator's Submenu**
Press this icon to access the Integrator's menu.

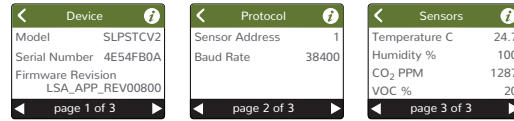
Submenu Only



 **Occupied Override Button**
Press this icon to provide momentary signal output to the controller

Single Press Only

 Signals occupied/override call to controller.

 **Fahrenheit/Celsius Switch**
Press this icon to display either °C or °F.

Single Press Only

 Changes units to Fahrenheit when pressed.

 Changes units to Celsius when pressed.

 **Settings**
This icon provides the ability to change the color scheme of the display.

Submenu Only

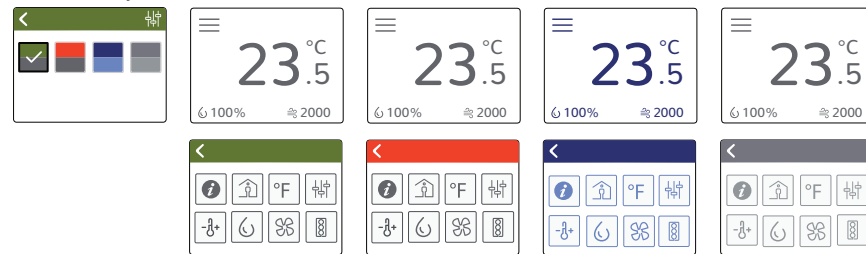

 **Temp Setpoint Adjustment**
Click this icon to access the setpoint change menu.

Submenu Only

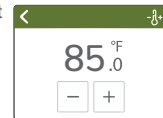

 **Humidity Setpoint Adjustment**
Click this icon to access the setpoint change menu.

Submenu Only

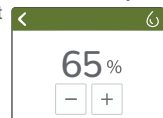

 **Fan Speed**
Click this icon to access the fan speed menu.

Submenu Only

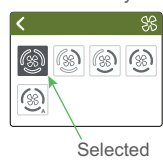

Menu Button Functions (cont.)

CO₂ Stoplight Menu
 Click this icon to toggle the CO₂ Stoplight feature on and off. With CO₂ Stoplight turned on, the background color of the main screen changes with CO₂ level. This provides a visual indicator of CO₂ levels to the room occupants.

Using the +/- buttons, the thresholds at which the colors change on the main screen are user configurable, as described in the diagram.

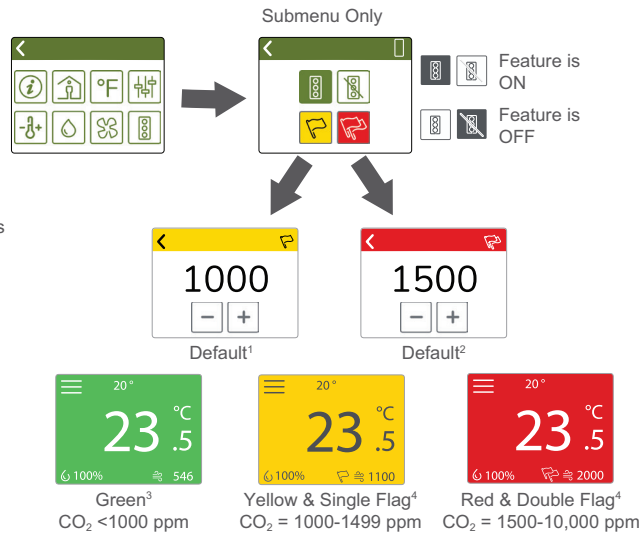

1. Values <400 ppm will be rounded up to the minimum limit of 400 ppm.
2. Values >10,000 ppm will be rounded down to the maximum limit of 10,000 ppm.
3. Possible to adjust CO₂ thresholds by changing the yellow and red limits.
4. User configurable in increments of 10 ppm using the +/- buttons. With a long press of these buttons, the number will change more quickly.

LCD Display Operation Button Functions

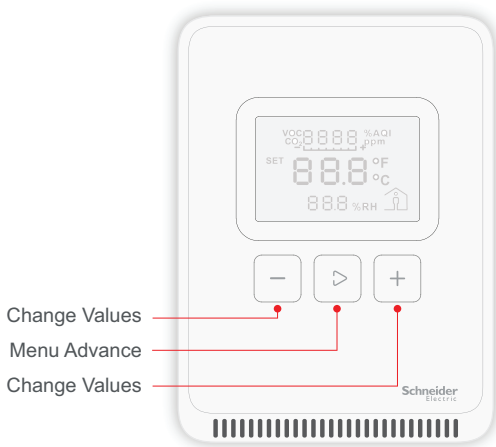

Display Icons

The main screen displays sensor values for CO₂, VOC (if equipped), RH (if equipped), temperature or temperature set-point and Celsius/Fahrenheit.

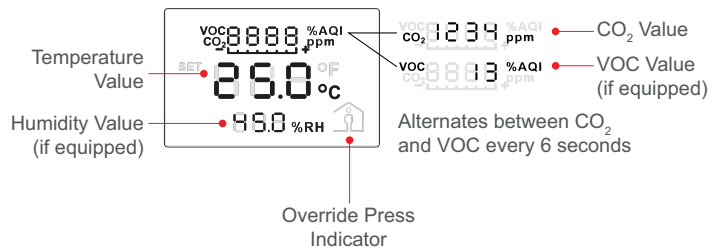

USA: +1 888-444-1311
 Europe: +46 10 478 2000
 Asia: +65 6484 7877
www.schneider-electric.com

Life Is On



Setpoint Function

The Menu Advance button cycles between Temperature, RH (if equipped), Fan Speed setpoints and Celsius/Fahrenheit adjustment screens in order.

Temperature Setpoint Adjustment



Note: Numeric information will flash while in Set mode.

RH Setpoint Adjustment



Note: Numeric information will flash while in Set mode.

Fan Speed Setpoint Adjustment

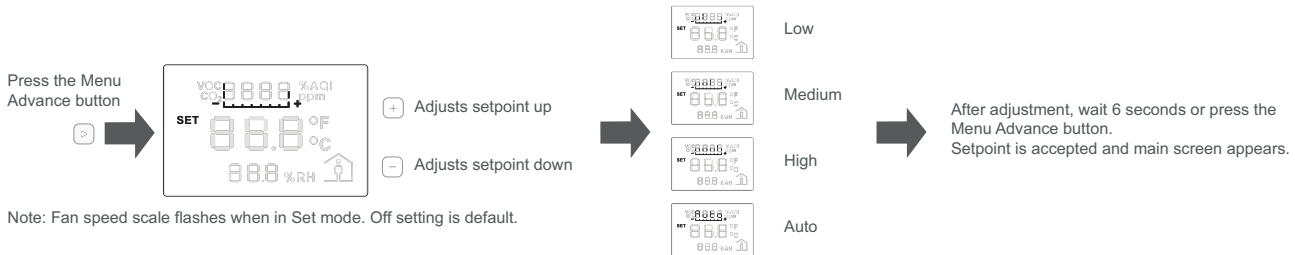

Note: Fan speed scale flashes when in Set mode. Off setting is default.

Changing Celsius and Fahrenheit Scales

The Menu Advance button cycles between Temperature, RH (if equipped), Fan Speed setpoints and Celsius/Fahrenheit adjustment screens in order.



Note: °F or °C text will flash while in Set mode.

Occupied/Override Button

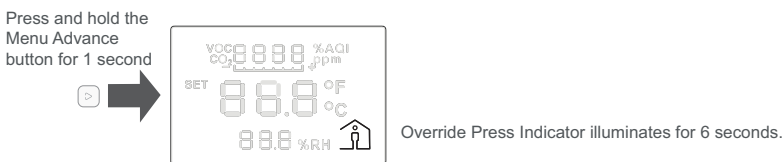

China RoHS Compliance Information Environment-Friendly Use Period (EFUP) Table

部件名称	有害物质 - Hazardous Substances					
Part Name	铅 (Pb)	汞 (Hg)	镉 (Cd)	六价铬 (Cr (VI))	多溴联苯 (PBB)	多溴二苯醚 (PBDE)
电子件 Electronic	X	O	O	O	O	O

本表格依据SJ/T11364的规定编制。

O: 表示该有害物质在该部件所有均质材料中的含量均在GB/T 26572规定的限量要求以下。

X: 表示该有害物质至少在该部件的某一均质材料中的含量超出GB/T 26572规定的限量要求。

(企业可在此处，根据实际情况对上表中打“X”的技术原因进行进一步说明。)

This table is made according to SJ/T 11364.

O: indicates that the concentration of hazardous substance in all of the homogeneous materials for this part is below the limit as stipulated in GB/T 26572.

X: indicates that concentration of hazardous substance in at least one of the homogeneous materials used for this part is above the limit as stipulated in GB/T 26572

Z000057-0B